

# PowerFlex® Low Voltage AC Drives Selection Guide



Powerful Performance. Flexible Control.



LISTEN.  
THINK.  
SOLVE.®





## PowerFlex Low Voltage Drives Selection Guide

<b>Drive Productivity with the Versatile PowerFlex Family</b> .....	2
<b>What's New</b> .....	14
<b>PowerFlex Drives At-a-Glance</b> .....	18
<b>PowerFlex Drives Selection</b>	
PowerFlex 4M .....	22
PowerFlex 4 .....	25
PowerFlex 40 .....	29
PowerFlex 40P .....	33
PowerFlex 400 .....	36
PowerFlex 4-Class Options .....	39
PowerFlex 523 .....	46
PowerFlex 525 .....	49
PowerFlex 520-Series Options .....	52
PowerFlex 70 .....	57
PowerFlex 700 .....	64
PowerFlex 700H .....	70
PowerFlex 700S .....	75
PowerFlex 700L .....	81
PowerFlex 753 .....	84
PowerFlex 755 .....	91
PowerFlex 7-Class Options .....	116
<b>Rockwell Automation Services &amp; Support</b> .....	138
<b>Additional Resources</b> .....	139





# Drive Productivity with the Versatile PowerFlex Family

*Powerful performance. Flexible control.*

Every drive in the Allen-Bradley® PowerFlex family has been designed with your productivity in mind – regardless of your application. The broad range of control modes fits virtually any motor control requirement, while the combination of features, options and packaging provides application versatility. Add in simplified programming and configuration – along with safety features designed to not only protect personnel and assets but also reduce downtime – and you’ll find there’s a PowerFlex solution to meet your application demands.

With a complete portfolio covering global voltages and a wide range of power ratings, the PowerFlex family of drives offers a common user experience – out of the box and on the line.

**Compact PowerFlex** drives deliver a simple and cost effective solution for machine level, stand alone control applications or simple system integration. Designed for ease of use, this general purpose class of drives provides a compact package to optimize panel space and application versatility.

**Architecture PowerFlex** drives provide a broad set of features, application specific parameters and are ideal for high performance applications. This class of drives is designed for advanced application flexibility and control system integration.

## Scalable, Flexible Motor Control

Because there are a wide variety of application requirements, PowerFlex drives offer a broad range of motor control solutions. From open loop speed regulation to precise position, speed and torque control, the PowerFlex family of drives can meet the simplest to the most demanding applications. The family also features a wide selection of hardware, software, safety and packaging options to help fit your needs.

- Reduce total cost of ownership by selecting a drive built for application requirements, with as many options as the application requires
- Boost productivity with specific application control such as TorqProv™ for lifting applications and Pump-Off for oil wells
- Protect against unplanned downtime with advanced diagnostics and notification of irregular operating parameters
- Easily configure and commission with software, tools and wizards

*“There’s no way we could have been as successful as we were without Rockwell Automation. From mechatronics to motor and drive selection to start-up support, Rockwell Automation has provided an immense amount of value during every step of the design and delivery process.”*

*Rodney Pennings  
Paper Converting Machine Company – US*



## Motor Control

For optimized motor control solutions for any application, the PowerFlex family leverages a wide range of control technologies to give you the ability to meet virtually any application requirement from open loop speed regulation to precise torque and speed control. Support for a wide range of motors – including induction motors, surface-mounted permanent magnet motors and interior permanent magnet motors – provides flexibility.

In addition to industry standard motor control, the PowerFlex family offers unique control technologies that can provide you with even greater application flexibility.

**FORCE™ Technology** – FORCE is the Allen-Bradley patented Field Oriented Control, which is a version of Flux Vector Control. This provides excellent low speed/zero speed performance and delivers accurate torque and speed regulation.

*“We believe in maintaining motors for the long run. It saves us more money to dedicate our efforts toward protecting these motors instead of running them until they break.”*

*Bob Wright  
Ash Grove Cement – US*

**DeviceLogix™** – DeviceLogix is an embedded control technology in selected Allen-Bradley products that can control outputs and manage status information onboard a device. A drive with DeviceLogix technology can help improve system performance and productivity by controlling outputs and managing status and information within the drive. Help speed reaction time by processing in the drive, which reduces dependency on network throughput and provides an option for decision making if communication is lost with the main controller. This technology can be found in the PowerFlex 750-Series.

**DriveLogix™** – The PowerFlex 700S AC Drive with DriveLogix option offers an embedded Logix processor to provide optimized integration for demanding control in drive systems or stand-alone applications. The PowerFlex 700S drive with DriveLogix supports the common programming environment and multiple programming languages supported by all Logix platforms.

**SynchLink™** – A drive-to-drive data link available in the PowerFlex 700S drive is a high-speed, synchronous, drive-to-drive data link for transmitting synchronized drive and application data. SynchLink offers process coordination and performance beyond that of standard control networks.





### **Specific Application Control**

Select PowerFlex drives have specialized drive parameters configured to support a particular application. Application Sets are a configuration of the standard drive parameters designed to simplify a user's implementation of a standard drive application without the need for custom programming.

**Positioning** – The PowerFlex 40P, 525, 700, 700S and 750-Series are optimized for single-axis applications. With features ranging from simple position and velocity profiling and point-to-point planners to more complex electronic gearing, registration, homing and safety capabilities these drives are ideal for speed and position control applications.

**TorqProve™** – For lifting applications this helps ensure control of the load in any lifting or hoisting application. This advanced control capability assures that the mechanical brake has control of the load when stopping the drive and the drive has control of the load when releasing the brake during any move command. Combined with patented FORCE™ Technology, TorqProve helps eliminate concerns with brake timing and environmental changes and can significantly reduce wear and tear on mechanical brake with smooth operation and reduced machine stress. This standard feature is available in the PowerFlex 700 and 755.

**Pump Off** – This unique feature specific for oil well applications is a patented pump-off function that measures the torque and currents on a motor to determine flow from a well. This alternative to traditional mechanical flow meters allows pump operators to optimize production based on the flow of the well and can also help reduce downtime by protecting the rod and motor assets. This feature is available in the PowerFlex 700, 753 and 755 drives.

*"We needed drives that were easy to integrate and small enough to fit in the limited space available ... When we saw how simple it was to integrate Allen-Bradley AC drives with our Allen-Bradley ControlLogix controllers thanks to the Integrated Architecture system, we were sold."*

*Chuck Atchison  
Leitner-Poma – US*





## Enclosures

The PowerFlex family of drives are available with factory and field installable enclosure options to meet most environmental requirements. These packaging options include open type cabinet mount, extra protection flange mount and extra protection wall mount for harsh environments and meet IP and NEMA requirements including:

- IP00/IP20 & NEMA/UL Open Type
- IP66 & NEMA/UL Type 4X and 12
- IP54 & NEMA/UL Type 12



*"With the EtherNet/IP connectivity enabled by the drives, we're able to access a wide range of operating and performance data. We can track run time off of the drives themselves, and monitor loads and other parameters for better diagnostics and more proactive maintenance."*

*Richard Stewart  
Evergreen Packaging – US*

## Communications

Easily manage information from shop floor to top floor and seamlessly integrate your complete system while controlling, configuring and collecting data.

The Allen-Bradley PowerFlex family of drives uses open network architecture, which provides the common set of features and services for the common industrial protocol (CIP) used in EtherNet/IP™, DeviceNet™ and ControlNet™. Providing the ability to control, configure and collect data on a single network simplifies plant communication and can help lower total cost of ownership.

CIP is a major component within the Open Network Architecture, and it provides you with the following common features:

- **Common control services** – provides you with a standard set of messaging services for all three networks within the NetLinx architecture.
- **Common communication services** – lets you configure and collect data from any network using common routing capabilities. This saves time and effort during system configuration because no routing tables or added logic are necessary to move data between networks.
- **Common base knowledge** – reduces the amount of training needed when moving to different networks within the architecture by providing similar configuration tools and features.

EtherNet/IP allows you to connect your entire enterprise on a single network and collect detailed status information to make data-driven decisions.

In addition to linear and star network topologies, optional dual port EtherNet/IP allows PowerFlex drives to support device level ring (DLR) topologies. This can help reduce your cabling needs, gives your system resiliency from the loss of one network connection and provides fault-tolerant connectivity for optimum drive availability.

In addition to CIP open network architecture, PowerFlex drives are capable of supporting industrial protocols found throughout the world. See the drive options for more details.

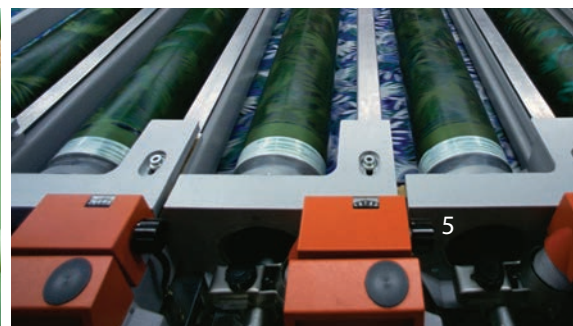

# Premier Integration Simplifies Development, Use and Maintenance

By combining the advanced capabilities of the Rockwell Automation Integrated Architecture and the communication capabilities of PowerFlex drives, you can achieve an exceptional level of integration between drives and controllers. The benefits of this time-saving integration range from reduced development time to simplified maintenance.

To achieve this integration, PowerFlex drives use add-on profiles in Studio 5000™ Logix Designer software (formerly RSLogix™ 5000) to streamline drive installation.

Add-on profiles minimize the need to individually program the required parameters and tags. You no longer have to complete complicated programming functions when installing PowerFlex drives or constantly refer back to user manuals for specific parameter and tag information. All PowerFlex drives on EtherNet/IP or ControlNet are able to take advantage of these add-on profiles.

In addition, Automatic Device Configuration (ADC) support for the PowerFlex 753\*, PowerFlex 755, PowerFlex 523\* and PowerFlex 525 AC drives helps reduce downtime. With ADC, an Allen-Bradley Logix controller can automatically detect a replaced PowerFlex drive and download all configuration parameters. This feature is available for PowerFlex drives on EtherNet/IP.

## Easy-to-use tools help reduce development time and require no specialized knowledge

- Dynamically select drive parameters transmitted as network I/O
- Auto-generation of descriptive tag names minimizes the need to enter individual tag descriptions
- Auto-generation of respective tag data types minimizes the need to convert from one data type to another

- Wizards with advanced graphical interfaces walk you through drive parameter configuration
- Minimize errors associated with using multiple software tools
- Single development environment to configure and program your entire Logix/drive system
- Configuration of both controller and drive network connections from a single location minimizes I/O mismatch errors
- Copy and paste function makes duplicating drives fast and easy
- Drives can be added to the system at any time without the need to shut down production

## Access, edit and save drive information to the control system project with ease

- Drive configuration is saved as part of the Studio 5000 Logix Designer (or RSLogix 5000) project file (\*.acd) and also stored in the Logix controller, so there's no need to store and maintain multiple files – you only need one file for both the controller and all drive configurations

## Easily download global objects and faceplates

- You can use the same tag names generated by the drive add-on profiles to utilize global objects and faceplates for a FactoryTalk® View HMI display

## Easy to Maintain

- Diagnostic, fault, alarm, and event information are integral to Studio 5000
- Single repository of configuration data speeds drive replacement
- Continue to use DriveTools SP to import and export drive configuration files between the family of PowerFlex drive programming tools and Studio 5000

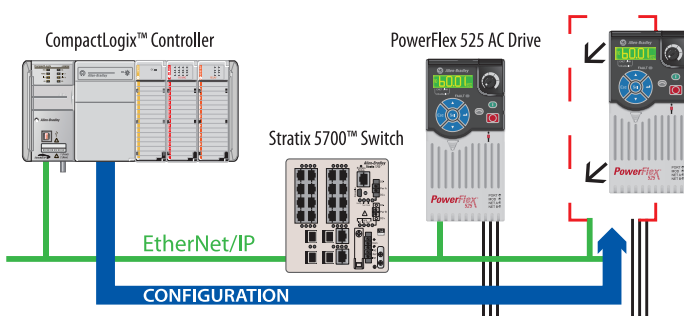

With Automatic Device Configuration (ADC), the Logix controller can automatically detect a replaced PowerFlex 523\*, 525, 753\* or 755 drive and download all configuration parameters, minimizing the need for manual reconfiguration. This productivity-enhancing feature is available with Studio 5000 Logix Designer and RSLogix 5000 v20. ADC compliments automatic IP address assignment with Stratix switches and firmware updates with Firmware Supervisor.

\* PowerFlex 523 and 753 require a dual-port EtherNet/IP communication card for ADC



# Drive Control Instructions in the Logix Environment for PowerFlex Drives

PowerFlex 755 AC drives offer the option of configuration with drive instructions embedded in Allen-Bradley ControlLogix® and CompactLogix™ Programmable Automation Controllers (PAC). These are the same configuration parameters and programming instructions used by Allen-Bradley Kinetix® servo drives. The generated application code can be applied to both drive platforms to significantly reduce programming time and provide a common, enhanced user experience.

Engineering tools within a single software package – Studio 5000™ Logix Designer – provide simplified configuration, programming, commissioning, diagnostics and maintenance for the PowerFlex 755 and Kinetix servo drives. This integration simplifies use and helps to deliver the accuracy and synchronization required by the application.

In addition, the use of EtherNet/IP for your PowerFlex and Kinetix drives helps to increase machine design flexibility, improve system performance, and reduce system cost.

- EtherNet/IP uses standard networking, and allows you to effectively manage real-time control and information flow for improved plant-wide optimization, more informed decision-making and better business performance
- This EtherNet/IP-based solution uses CIP Motion™ and CIP Sync™ technology from ODVA built on the Common Industrial Protocol (CIP)

Graphical Motion Profile Editor      Instruction Based Programming

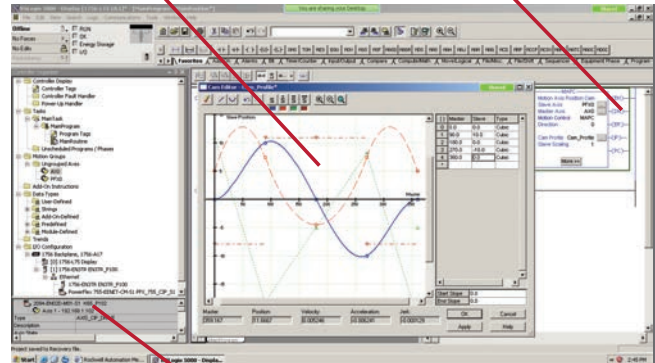

Drive Status and Diagnostics

Studio 5000™ Logix Designer (and some versions of RSLogix 5000) software provides complete support for PowerFlex 755 VFD drives and Kinetix servo drives for standardized operation and consistent behavior of the drives. The common user experience simplifies drive use.

- By sharing the same instructions, a Kinetix servo drive and a PowerFlex 755 AC drive have identical programming within Studio 5000™ Logix Designer and RSLogix 5000 software. The standardized operation and consistent behavior of the drives simplifies use
- Time synchronization of drives, I/O and other EtherNet/IP compliant devices provides the performance to help solve the most challenging applications
- Use of standard EtherNet/IP allows you to connect to a large number of commercial and industrial devices; there's no need for proprietary hardware or software

## EtherNet/IP—A Single Network for Complete Machine Control

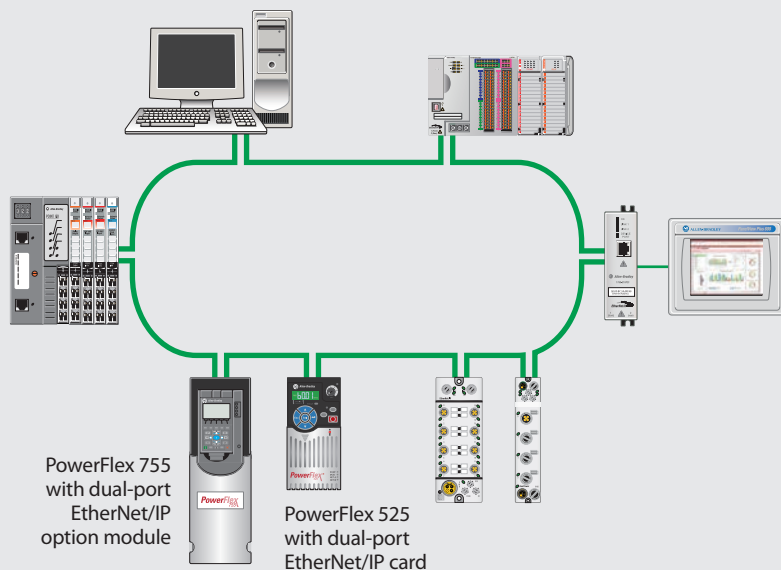

### Connect Your Entire Enterprise

Benefit from the EtherNet/IP network for complete machine control that simplifies and enhances machine design.

- Low cost, high performance and easy to use as compared to a multi-network architecture
- Easily integrate any PowerFlex drive, I/O, smart actuators and any other EtherNet/IP connected device
- Dual-port EtherNet/IP connectivity supports ring topologies, which provide device level ring (DLR) functionality and optimum drive availability
- EtherNet/IP is an established, broadly-adopted network

# Safety Solutions that Help Improve Productivity

Safety is a crucial concern for every type of automation. Protecting personnel and assets is always a high priority, with far-reaching benefits. However, in the past, implementing safety solutions often meant sacrificing productivity. PowerFlex AC drives can assist you in solving that dilemma by helping to provide protection for your people and equipment while also reducing unplanned downtime.

PowerFlex AC drives offer safety options designed to help you best meet the needs of your application. PowerFlex 40P, 70, 700H, 700S and 750-Series AC drives are available with optional Safe Torque-Off (DriveGuard®) functionality offering Safe-off control. Safe Torque-Off is a standard embedded feature on the PowerFlex 525 AC drive.

Safe Torque-Off is ideal for safety related applications requiring removal of rotational power to the motor without removing power from the drive. Safe Torque-Off functionality offers the benefit of quick start-up after a demand on the safety system and helps reduce wear from repetitive start-up. It provides safety ratings up to and including PLe/SIL and CAT 3.

The Safe Speed Monitor provides a solution for applications using PowerFlex 750-Series AC drives that can benefit from access to a safety zone while there is limited motion. In addition, the Safe Speed Monitor has an integrated monitoring relay to save additional panel space installation labor. This option carries a safety rating up to and including PLe/SIL and Cat 4. With the Safe Speed Monitor option you can safely monitor and control the speed of your application which allows operators to perform process or maintenance work without stopping the machine.

Drives without a safety option can be configured with the MSR57P Safety Relay to achieve the same safe limited speed capability and safety ratings.

## Safe Speed Monitor option provides the following functionality:

- Safe Torque-Off
- Stop Categories 0 and 1
- Safe Stop
- Safe Limited Speed
- Safe Maximum Speed
- Safe Direction
- Safe Maximum Acceleration
- Zero Speed Monitoring
- Door Control and Monitoring
- Enabling switch input

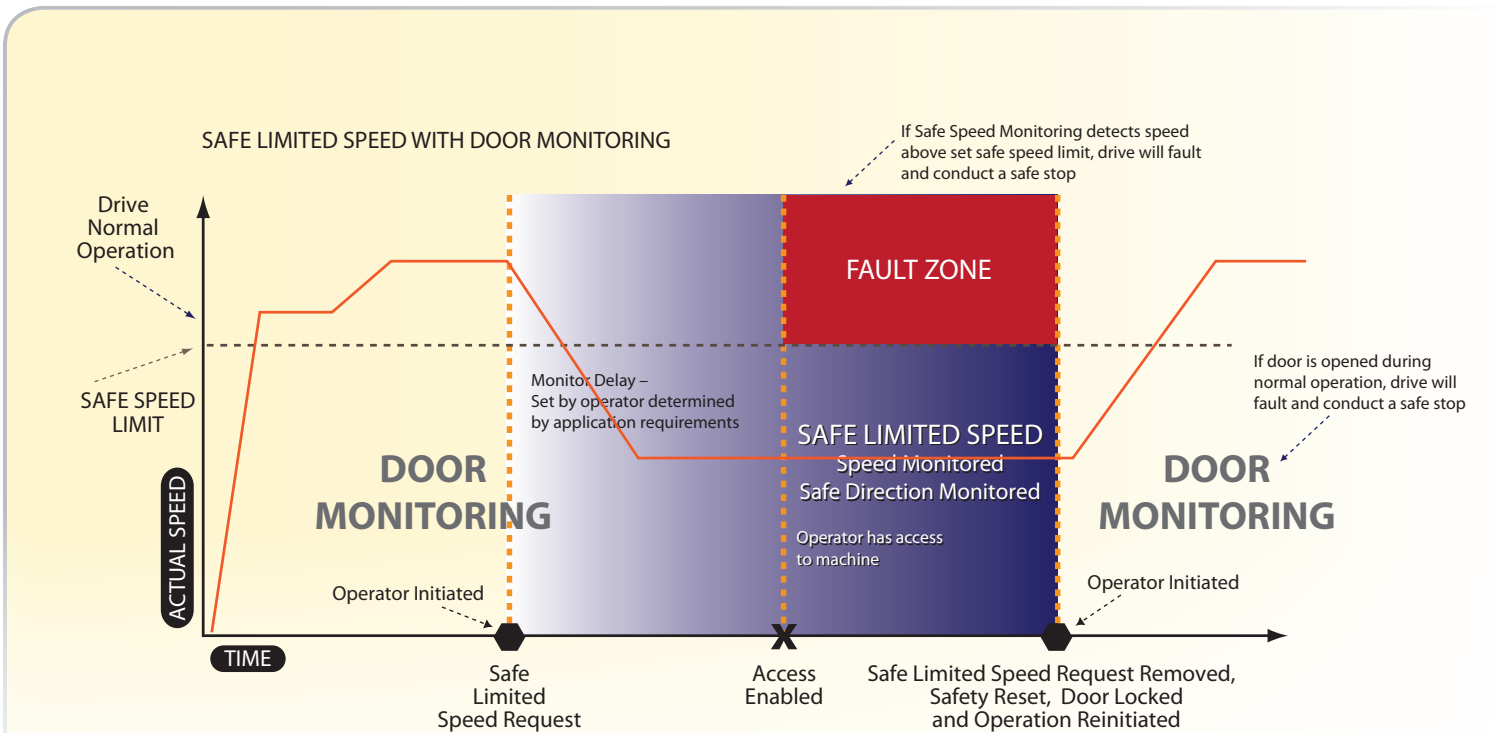



# The Right Motor Solution for Improved Efficiency

## Drive Efficient Operations

Improved motor control performance and motor efficiency means greater overall production efficiency. PowerFlex drives are capable of providing both an immediate and measurable impact on energy use and operational efficiency.

- Help reduce and track energy consumption by applying a PowerFlex drive to your application
- Predict mechanical problems and help improve performance with diagnostics and real time data
- Access historical data directly from the factory floor

## Entire Plant Solutions from Plant Floor to Top Floor

As a global automation leader, Rockwell Automation is uniquely positioned to help our customers capitalize on the business benefits of integrating factory floor controls and enterprise systems.

When you choose a PowerFlex drive, you are receiving industry-leading motor control and protection, plus the advanced system-wide communication capabilities of the Rockwell Automation Integrated Architecture™. With this you get an Intelligent Motor Control solution, where you can expect faster programming and installation, decreased mechanical wear, reduced energy consumption and improved motor performance.

## World Class Offering

The PowerFlex family of drives is backed by over 100 years of motor control application and expertise.

- Meet most environmental requirements with factory and field installable packaging options from cabinet and wall mount to extra protection for harsh environments
- Meet standards worldwide including UL, CE, CUL, C-Tick, RoHS
- Support drive system installation with the largest network of services and support

## Energy Savings Calculators

See how installing a PowerFlex drive for your fan or pump applications can reduce energy costs when compared with a traditional flow control method.

Download the tools at:

<http://www.rockwellenergycalc.com>



*"While installing the drive, we were able to integrate the new solution with the existing components without interrupting services."*

Esposito Orfino  
Syel - Italy



## Line & Load Options

Typical drive application

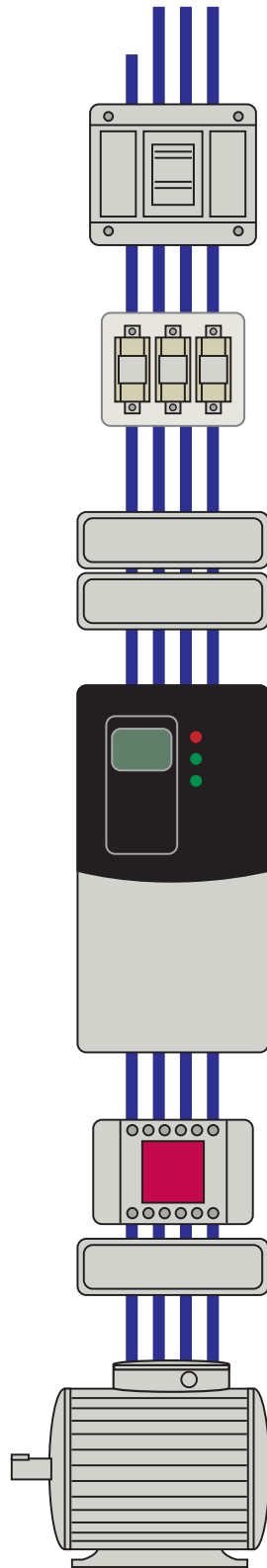

### AC supply source

Input line reactor recommended when line voltage imbalances are greater than 2%

### Input fusing and circuit breakers

See listings in the product user manuals.

### Line reactor

Needs to be applied if:

- a) Installation site has switched power factor correction capacitors
- b) Installation site has power interruptions or voltage dips
- c) The transformer is too large in comparison to the drive ([www.rockwellautomation.com/literature](http://www.rockwellautomation.com/literature), refer to publication: DRIVES-IN001\_).

### Input filter

Compact PowerFlex drives: External EMC filter required for EMC compliance. With PowerFlex 523 and PowerFlex 525 AC drives, EMC filtering is embedded at 200V and 400V. Architecture drives: External EMC filter only required with long motor cables and/or specific immunity requirements.

### AC drive

Normal duty (ND) rating: 110% overload for 1 minute and 150% overload for 3 seconds. No excessive starting overload, transient overload or high duty cycle. The majority of typical AC drive applications are ND.

Heavy duty (HD) rating: 150% overload for 1 minute and 180% overload for 3 seconds. Required for high starting torque (e.g., heavily loaded conveyors), high brake-away torque (e.g., extruders and mixers) and high running torque (e.g., reciprocating compressors).

### Output device or cable termination

Required if motor cable lengths exceed stated values ([www.rockwellautomation.com/literature](http://www.rockwellautomation.com/literature), refer to publication: DRIVES-IN001\_).

### AC motor



## Product Selection Toolbox

The Product Selection Toolbox is a collection of product selection and system design software tools that help you select Allen-Bradley products and design application solutions using those products.

From this tool you can create a single bill of material for the complete range of Allen-Bradley products; configure Motor Control Bus Systems, Motor Control Centers, Automation Systems, and Motion Control Systems; and create project bids and submittal documents.

### Product Selection

- Drive Selector Wizard in ProposalWorks™ – Select a Low Voltage Drive
- Integrated Architecture Builder – Configure Automation Systems
- CenterONE® – Design Low Voltage Motor Control Centers
- MCS™ Star – Design Modular Motor Control Systems

## System Design and Support Tools

- eCADWorks – Get CAD Drawings
- MotionAnalyzer – Design tool for speed and positioning applications
- RailBuilder™ – Design DIN Mountable Systems

Download the tools at:

<http://www.rockwellautomation.com/en/e-tools/>

## Motion Analyzer

For applications requiring more than a constant load and steady speed, Motion Analyzer software can help by handling the necessary complex calculations. Motion Analyzer features an easy-to-use format which can reduce design risk for speed and positioning applications that include PowerFlex drives or Kinetix servo drives.

Download the tool at:

<http://ab.rockwellautomation.com/Motion-Control/Motion-Analyzer-Software>

## Drives and Motion Accelerator Toolkit

This collection of design tools can help you significantly reduce the time and cost of developing a new application using Allen-Bradley equipment, especially PowerFlex® AC Drives and Kinetix® Servo Drives

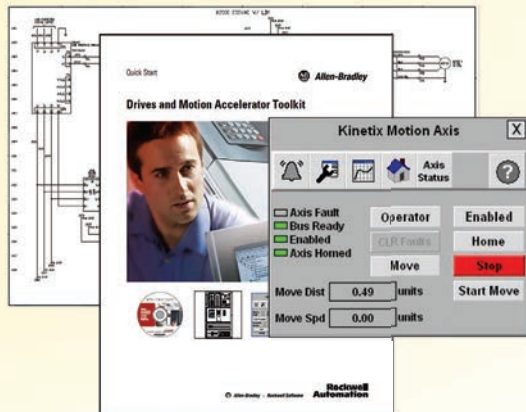

The toolkit includes the powerful System Development Wizard which takes system data entered by the designer and automatically generates the files you need to jumpstart your design, including:

- Custom Bill Of Material
- Custom set of CAD drawings
- Logic program for the specific controller, drives and names used in the application
- Custom set of instructions to quickly adapt a starting HMI application

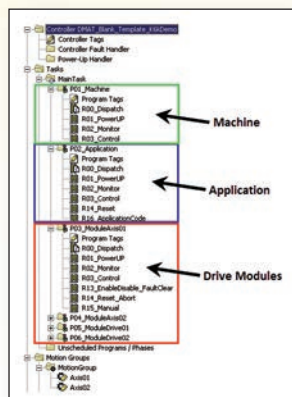

Information is delivered in a modular format.

- Module provides control and information for individual product or function
- Selecting specific modules allows you to tailor the application
- Modules are designed to interact in standard understandable and usable ways
- Selects the specific modules needed for the application
- Selected modules are combined, using standard design tools, to build starting BOM, CAD, Logic and HMI application files

Download the tool at: [www.ab.com/go/iatools](http://www.ab.com/go/iatools)

# Connected Components Workbench

Connected Components Workbench™ programming and configuration software supports PowerFlex AC drives, Micro800™ controllers, PanelView™ Component graphic terminals, and other select Allen-Bradley® devices. This software leverages proven Rockwell Automation and Microsoft® Visual Studio® technologies for fast and easy drive configuration, controller programming, and integration with the HMI editor.

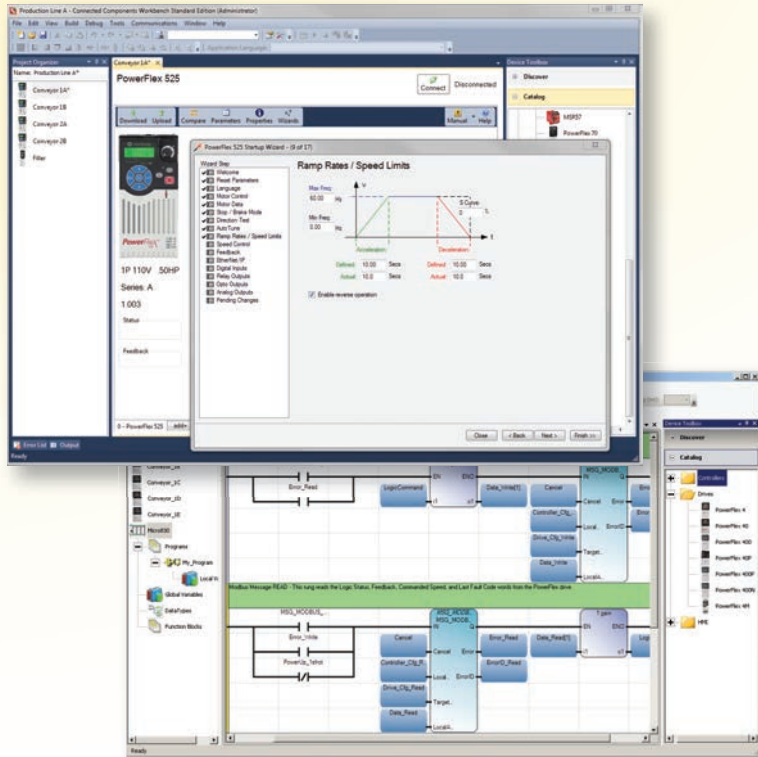

## Drive features include:

- Online and offline configuration
- Linear List Parameter Editor
- Uses the same wizards as DriveExecutive
- Easy access to embedded device user manuals
- Context-sensitive "Help"
- Localized language support
- Connection path is saved with device, reducing time for each subsequent connection
- View and clear fault queue, clear faults
- View and clear event queue, clear events
- View diagnostic items
- Reset drive/peripheral

## General features:

- Free software is easy to acquire and install
- Convenient, single development environment (controller, HMI, drives)
- Add a device via simple drag and drop from a catalog of available components or go online to add devices to your project
- IEC1131 programming using ladder, function block, and structured text
- User-defined function blocks optimize control of your machine

## Faster Configuration with AppView™ and CustomView™

Leverage a new convenient feature to speed up your PowerFlex 523 and 525 drive configuration in Connected Components Workbench with the AppView tool. This feature highlights parameter groups for several of the most common applications, including conveyors, mixers, compressors, pumps and blowers.

With the settings to run these applications already in place, you can get your machine up and running faster, increasing your productivity. You can customize your machine and reduce your design and development time by quickly creating custom groups of parameters using the CustomView™ configuration tool.

This programming option, available through the HIM or Connected Components Workbench, allows you to customize your configuration by adding or removing parameters from an AppView group or save your own custom group of parameters.

Download Connected Components Workbench software at:  
<http://www.ab.com/go/ccws>



# Drive Integration with Studio 5000

The Rockwell Automation Integrated Architecture™ system provides a convergence of control and information to help you achieve plantwide optimization. At the heart of an Integrated Architecture system, the Studio 5000 environment (formerly RSLogix 5000) serves as a single programming tool for the design and configuration of your application. PowerFlex drives are also backwards compatible with most versions of RSLogix 5000.

With the Studio 5000 Logix Designer application, you need only one software package for discrete, process, batch, motion, safety and drive-based applications. Through the use of custom add-on profiles or embedded instructions, PowerFlex AC drives can achieve seamless integration into the Logix environment for simplified machine development, use and maintenance.

The Studio 5000 Logix Designer application offers an easy-to-use, IEC61131-3 compliant interface, symbolic programming with structures and arrays and a comprehensive instruction set that serves many types of applications. It provides ladder logic, structured text, function block diagram and sequential function chart editors for program development.

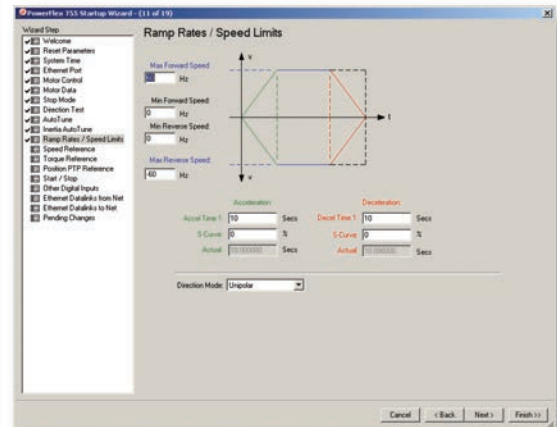
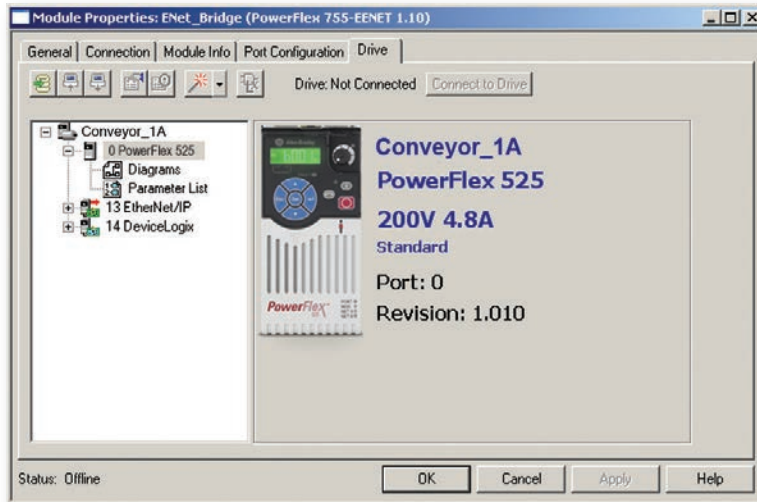
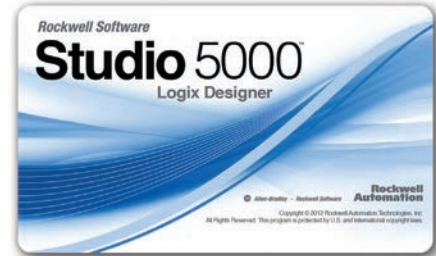

## Save Development Time with PowerFlex Drives and Studio 5000 Logix Designer

- Easy-to-use tools require no specialized knowledge
- Eliminates errors associated with redundant programming and configuration
- Access, edit and save drive information to a control system project with ease
- Free FactoryTalk View global objects and faceplates speed HMI development
- Flexible I/O configuration with simple drop-down boxes allows selection of specific drive data needed
- Automatic generation of descriptive tag names with proper data types
- Add a new drive node online (RSLogix 5000 v17 and higher)
- Utilizes same convenient wizards found in DriveTools SP

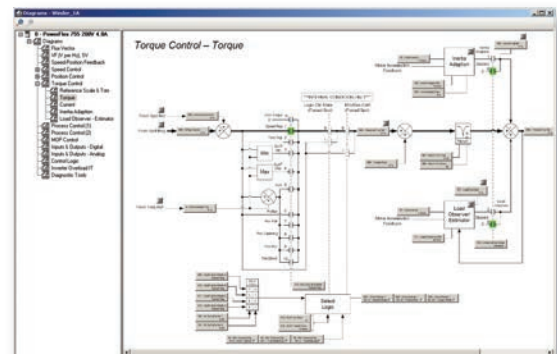

*The latest Drive Add-On profiles ship with each Studio 5000 Logix designer release. New drive products / firmware releases can occur between Studio 5000 releases, so up-to-date Drive Add-On Profiles are also available via free download at: <http://www.ab.com/support/abdrives/webupdate/software.html>*

# What's New

## PowerFlex 520-Series AC Drives:

### The Next Generation of Compact AC Drives

Allen-Bradley PowerFlex 520-Series AC drives combine an innovative design with simplified programming, versatile communications, installation flexibility and other features that will maximize your system performance and reduce your time to design and deliver better machines.

PowerFlex 520-Series AC drives provide the ease of installation and configuration, motor control and energy savings in a flexible, cost-effective drive that is ideal across a wide range of applications and industries. The newest drives, the PowerFlex® 523 AC drives are ideal for standalone machines and provide motor control for applications up to 22 kW/30 Hp. PowerFlex® 525 AC drives are designed for networked machines and simple system integration, offering standard features including embedded EtherNet/IP™ and safety and more performance up to 22 kW/30 Hp.

#### Innovative Design and Ease of Configuration

- Power ratings
  - PowerFlex 523 AC drives: 0.2...22 kW/0.25...30 Hp in global voltages from 100-600V
  - PowerFlex 525 AC drives: 0.4...22 kW/0.5...30 Hp in global voltages from 100-600V
- AppView™ application parameter groups help speed configuration for many common applications
- CustomView™ configuration helps speed machine commissioning with your own defined group of parameters
- Help reduce energy costs with Economizer control mode, energy monitoring features and permanent magnet motor control\* for PowerFlex 525 AC drives
- Drives operate in ambient temperatures from -20°C (-4°F) to 50°C (122°F). With current derating and a control module fan kit, up to 70°C (158°F)
- A wide range of motor control
  - Volts per hertz
  - Sensorless vector control
  - Closed loop velocity vector control and permanent magnet motor control\* for PowerFlex 525 AC drives

\*Permanent magnet motor control is scheduled for a future firmware release







### Innovative Design

Removable control modules easily allow simultaneous installation and programming, saving time.



### HIM

The LCD human interface module (HIM) supports multiple languages and features scrolling text. Parameter codes are followed by dynamic descriptions so you don't have to search through a manual for details.



### Embedded EtherNet/IP™

This standard feature for PowerFlex 525 AC drives provides Premier Integration into the Logix environment. An optional dual port card for EtherNet/IP™ supports device level ring (DLR) functionality for 520-Series AC drives.



### Versatile

PowerFlex 523 AC drives accommodate an accessory communication card while maintaining a compact footprint. PowerFlex 523 AC drives can contain a communication module and an encoder card at the same time.



### Safe Torque-Off

Embedded safety for PowerFlex 523 AC drives helps protect assets and personnel by removing rotational power from the motor without powering down the drive when a safety circuit is triggered.



### Simplified Programming

Helps you configure drives faster by using standard USB cables and intuitive software. Quickly program drives with a simple executable file to upload, download and flash settings.



# What's New

## PowerFlex 750-Series AC Drives:

New Drive Options Provide Additional Flexibility



PowerFlex 755 Drive\* and Power Option Bay with IP54/UL Type 12 enclosure.

\*Drive shown has the following power ratings:

- 500 – 850 kW @ 400V AC / 600 – 1350 Hp @ 480V AC
- 600 – 1000 Hp @ 600V AC / 560 – 900 kW @ 690V AC



The highly flexible empty option bay is available in six sizes, with options to match the drive's enclosure rating.

### Packaging Options to Match Your Application Requirements

**Power Option Bays** are available with all PowerFlex 755 floor mount drives (above 250 kW/350 Hp) and provide a cost-effective solution for power connection and circuit protection. Based on customer specifications, components are correctly sized and optimized for the appropriate overload duty rating. The power option bays are available with both IP20/UL Type 1 and IP54/UL Type 12 enclosures.

**An empty option bay** provides an elegant packaging option when expanding a PowerFlex 755 floor mount drive. This option provides a customizable space that allows you to add a dv/dt filter, braking module, harmonic filter or a variety of other similar options. Additional bus bar and bracket kits available to ease interconnection with the drive.

**A wiring bay** added to a floor mount PowerFlex 755 drive allows you to connect power wiring without rolling out the drive. The additional space provided by the wiring bay helps to simplify installation and provide flexibility.

**Coordinated Motor Control Center lineups** help you reduce footprint, cut installation time, decrease components and generate less heat. The PowerFlex 755 floor mount drives can interconnect with both the CENTERLINE 2500 and 2100 MCCs.



Continuous, side by side installation of PowerFlex 755 floor mount drives and MCCs helps to reduce the number of mechanical components and lessen floor space requirements.



# New Option Addresses Challenging Environments

## ATEX Certification for PowerFlex 750-Series Drives

A new ATEX option module enables Allen-Bradley PowerFlex 750-Series AC drives to be used in systems that require control of motors that are located in potentially explosive environments. When used with an 11-Series I/O module and the ATEX daughter card option module, the PowerFlex 753 and 755 drives are certified to stop providing energy to motors when motor temperature becomes too high. This helps to eliminate the risk of explosion due to an over-temperature condition in the ATEX-certified motor. ATEX Directive 94/9/EC is a European Union directive that describes what equipment is allowed in an environment with a potentially explosive atmosphere.

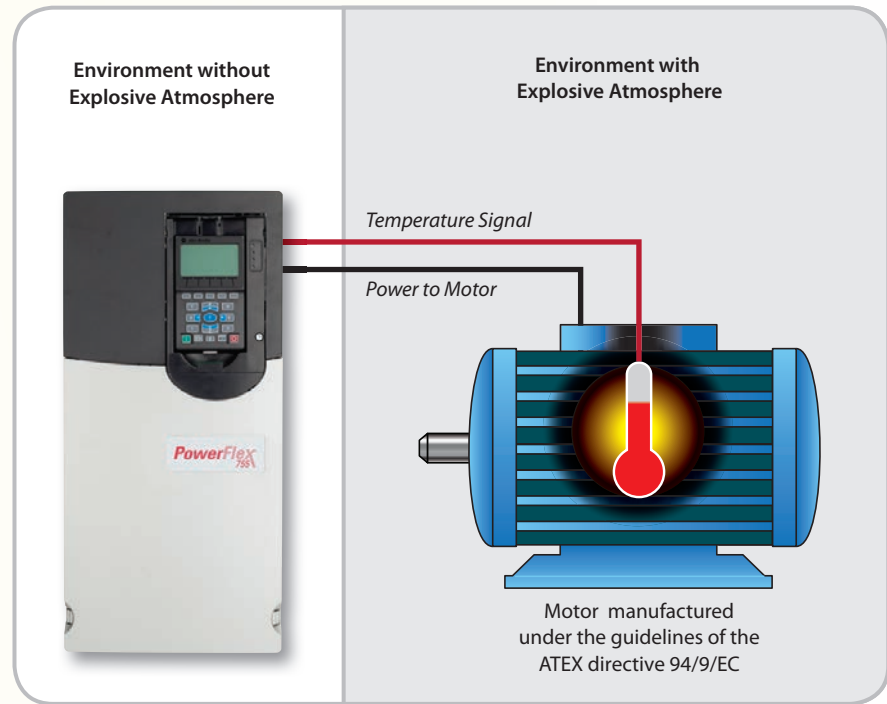

# Leverage the Benefits of EtherNet/IP in Multiple Topologies

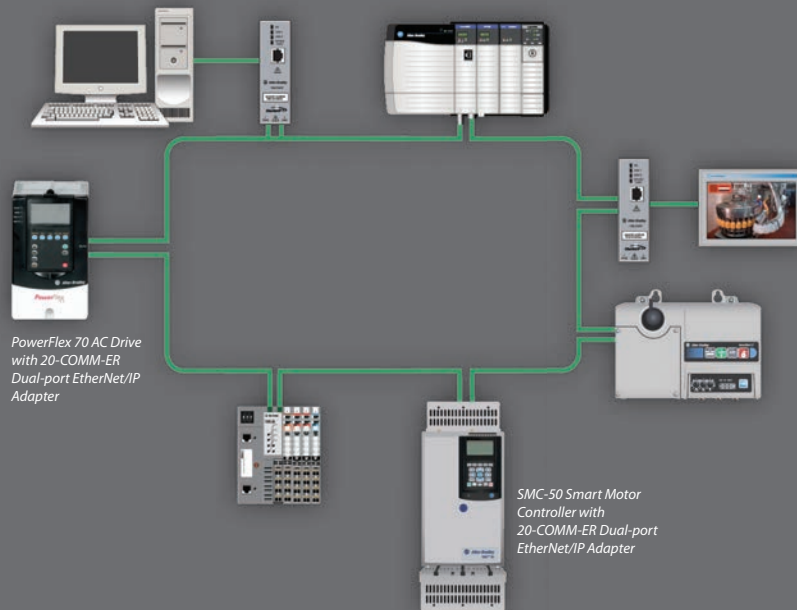

## New Communication Adapter

The 20-COMM-ER Dual-port EtherNet/IP™ communication adapter provides an internal network connection for:

- PowerFlex® 70, 700, 700H, 700S and 7000 AC drives
- PowerFlex DC drives
- SMC™ Flex and SMC-50 Smart Motor Controllers

The adapter is field-installable and provides a convenient way to control, configure and collect data over an EtherNet/IP network. The communication adapter supports linear, star and ring topologies as well as Device Level Ring functionality.

## POWERFLEX AC DRIVES

### Motor Control

### Application

Ratings 100-115V 1 Phase In/3 Phase 230V Out

Ratings 200-240V

Ratings 400-480V

Ratings 500-600V

Ratings 690V

Ambient Temperature \*  
Limit for Enclosure Types

### EMC Filters

### Standards and Certifications

### Overload Capability

### Output Frequency Range

### User Interface

### Communications Options

### Analog Inputs

### Analog Outputs

### PTC Inputs

### Digital Inputs

### Relay Outputs

### Transistor Outputs

### Dynamic Braking

### Integrated Safety

## PowerFlex 4M AC Drive



- Volts per Hertz
- Open Loop Speed Regulation
- 0.2...1.1 kW • 0.25...1.5 Hp • 1.6...6 A
- 0.2...7.5 kW • 0.25...10 Hp • 1.6...33 A
- 0.37...11 kW • 0.5...15 Hp • 1.5... 24 A
- N/A
- N/A
- IP20: -10 to 50 °C (14 to 122 °F)
- IP20 zero stacking: -10 to 40 °C (14 to 104 °F)

- Internal (1 phase 240V and 3 phase 480V)
- External (1 & 3 phase)

- UL, CE, cUL, C-Tick

- 150% for 60 secs • 200% for 3 secs

- 0...400 Hz

- Local Keypad • Remote Keypad
- RSLogix 5000 • Studio 5000 • DriveTools SP
- Connected Components Workbench (CCW)

- Integral RS485 (Modbus RTU)
- Optional: \*DeviceNet, \*EtherNet/IP, \*PROFIBUS DP, \*ControlNet, \*LonWorks®, \*Bluetooth®
- \*Optional network for use only with DSI External Communications Kit

- Qty. 1 (unipolar voltage)

- None

- Qty. 1 (uses an Analog Input)

- Qty. 5 (24V DC, 2 programmable)

- Qty. 1 (form C)

- None

- Internal IGBT except catalog numbers ending in "3"

- No

*Found on page 22*

## PowerFlex 523 AC Drive



- Volts per Hertz
- Sensorless Vector Control
- Open Loop Speed Regulation
- 0.2...1.1 kW • 0.25...1.5 Hp • 1.6...6 A
- 0.2...15 kW • 0.25...20 Hp • 1.6...62.1 A
- 0.4...22 kW • 0.5...30 Hp • 1.4...43 A
- 0.4...22 kW • 0.5...30 Hp • 0.9...32 A
- N/A
- IP20: -20 to 50 °C (-4 to 122 °F)
- IP20 Zero Stacking: -20\* to 45 °C (-4 to 113 °F)
- IP20: -20 to 60 °C (140 °F), with current derating
- IP20: -20 to 70 °C (158 °F) with current derating and optional control module fan kit

- Internal (1 phase 240V and 3 phase 480V)
- External (1 & 3 phase)

- UL, CE, cUL, C-Tick, RoHS, ACS 156, GOST-R, KCC, Semi-F47, REACH

- Heavy Duty Application: 150% - 60 secs, 180% - 3 secs (200% - 3 secs programmable)

- 500 Hz

- 5 Digits, 16 segments LCD display with multiple languages and local keypad • Remote Keypad
- MainsFree™ Programming via USB • RSLogix 5000
- Studio 5000 • Connected Components Workbench (CCW)

- Integral RS485 (Modbus RTU)
- Optional: Dual-port EtherNet/IP, DeviceNet, PROFIBUS DP

- Qty. 1 (unipolar voltage or current)

- None

- Qty. 1 (uses an Analog Input)

- Qty. 5 (24V DC, 4 programmable)

- Qty. 1 (form C)

- Qty. 2

- Internal IGBT

- No

*Found on page 46*

## PowerFlex 525 AC Drive



- Volts per Hertz • Sensorless Vector Control • Closed Loop Velocity Vector Control • Permanent Magnet Motor Control\*\*
- Open Loop Speed Regulation • Closed Loop Speed Regulation
- 0.4...1.1 kW • 0.5...1.5 Hp • 2.5...6 A
- 0.4...15 kW • 0.5...20 Hp • 2.5...62.1 A
- 0.4...22 kW • 0.5...30 Hp • 1.4...43 A
- 0.4...22 kW • 0.5...30 Hp • 0.9...32 A
- N/A
- IP20: -20 to 50 °C (-4 to 122 °F)
- IP20 Zero Stacking: -20\* to 45 °C (-4 to 113 °F)
- IP20: -20 to 60 °C (140 °F), with current derating
- IP20: -20 to 70 °C (158 °F) with current derating and optional control module fan kit

- Internal (1 phase 240V and 3 phase 480V)
- External (1 & 3 phase)

- UL, CE, cUL, C-Tick, TVU, ATEX, GOST-R, Semi-F47, Marine (Lloyds), ACS156, REACH, RoHS, KCC

- Normal Duty Application: 110% - 60 secs, 150% - 3 secs (For 20 Hp & above)
- Heavy Duty Application: 150% - 60 secs, 180% - 3 secs (200% - 3 secs programmable)

- 500 Hz

- 5 Digits, 16 segments LCD display with multiple languages and local keypad • Remote Keypad
- MainsFree™ Programming via USB • RSLogix 5000
- Studio 5000 • Connected Components Workbench (CCW)

- Embedded EtherNet/IP
- Integral RS485 (Modbus RTU)
- Optional: Dual-port EtherNet/IP, DeviceNet, PROFIBUS DP

- Qty. 2 (1 bipolar voltage, 1 current)

- Qty. 1 (unipolar voltage or current)

- Qty. 1 (uses an Analog Input)

- Qty. 7 (24V DC, 6 programmable)

- Qty. 2 (1 form A Relay, 1 form B Relay)

- Qty. 2

- Internal IGBT

- Embedded Safe Torque-Off, SIL2, PLd, Cat 3

*Found on page 49*

\* Environmental considerations may apply

\*\*Permanent magnet motor control is scheduled for a future firmware release



## PowerFlex 4 AC Drive



- Volts per Hertz
- Open Loop Speed Regulation
- 0.2...1.1 kW • 0.25...1.5 Hp • 1.6...6 A
- 0.2...3.7 kW • 0.25...5 Hp • 1.4...17.5 A
- 0.37...3.7 kW • 0.5...5 Hp • 1.4...8.7 A
- N/A
- N/A
- IP20, NEMA/UL Type Open: -10 to 50 °C (14 to 122 °F)
- IP20, Zero Stacking: -10 to 40 °C (14 to 104 °F)
- IP30, NEMA/UL Type 1: -10 to 40 °C (14 to 104 °F)
- Flange = 50 °C (122 °F)
- Internal (1 phase) • External (3 phase)
- UL, CE, cUL, C-Tick
- 150% for 60 secs • 200% for 3 secs
- 0...240 Hz
- Local Keypad • Remote Keypad
- RSLogix 5000 • Studio 5000 • DriveTools SP
- Connected Components Workbench (CCW)
- Integral RS485 (Modbus RTU)
- Optional: \*DeviceNet, \*EtherNet/IP, \*PROFIBUS DP, \*ControlNet, \*LonWorks, \*BACnet, \*Bluetooth
- \*Optional network for use only with DSI External Communications Kit
- Qty. 1 (unipolar voltage)
- None
- Qty. 1 (uses an Analog Input)
- Qty. 5 (24V DC, 2 programmable)
- Qty. 1 (form C)
- None
- Internal IGBT except catalog numbers ending in "3"
- No

Found on page 25

## PowerFlex 40 AC Drive



- Volts per Hertz
- Sensorless Vector Control
- Open Loop Speed Regulation
- 0.37...1.1 kW • 0.5...1.5 Hp • 2.3...6 A
- 0.37...7.5 kW • 0.5...10 Hp • 2.3...33 A
- 0.37...11 kW • 0.5...15 Hp • 1.4...24 A
- 0.75...11 kW • 1...15 Hp • 1.7...19 A
- N/A
- IP20, NEMA/UL Type Open: -10 to 50 °C (14 to 122 °F)
- IP20, Zero Stacking: -10 to 40 °C (14 to 104 °F)
- IP30, NEMA/UL Type 1: -10 to 40 °C (14 to 104 °F)
- IP66, NEMA/UL Type 4X/12: -10 to 40 °C (14 to 104 °F)
- Flange = 50 °C (122 °F)
- Internal (1 phase) • External (3 phase)
- UL, CE, cUL, C-Tick
- 150% for 60 secs • 200% for 3 secs
- 0...400 Hz
- Local Keypad • Remote Keypad
- RSLogix 5000 • Studio 5000 • DriveTools SP
- Connected Components Workbench (CCW)
- Integral RS485 (Modbus RTU)
- Optional: DeviceNet, EtherNet/IP, PROFIBUS DP, ControlNet, LonWorks, BACnet, Bluetooth
- Qty. 2 (1 bipolar voltage, 1 current)
- Qty. 1 (unipolar voltage or current)
- Qty. 1 (uses an Analog Input)
- Qty. 7 (24V DC, 4 programmable)
- Qty. 1 (form C)
- Qty. 2
- Internal IGBT
- No

Found on page 29

## PowerFlex 40P AC Drive



- Volts per Hertz
- Sensorless Vector Control
- Closed Loop Speed Regulation
- N/A
- 0.37...7.5 kW • 0.5...10 Hp • 2.3...33 A
- 0.37...11 kW • 0.5...15 Hp • 1.4...24 A
- 0.75...11 kW • 1...15 Hp • 1.7...19 A
- N/A
- IP20, Open Type: -10 to 50 °C (14 to 122 °F)
- IP20, Zero Stacking: -10 to 40 °C (14 to 104 °F)
- IP30, NEMA Type 1, UL Type 1: -10 to 40 °C (14 to 104 °F)
- Flange and Plate Mount: Heatsink: -10 to 40 °C (14 to 104 °F)
- Drive: -10 to 50 °C (14 to 122 °F)
- External
- UL, CE, cUL, C-Tick, TUV FS ISO/EN13849-1 (EN954-1)
- 150% for 60 secs • 200% for 3 secs
- 0...500 Hz
- 4 Digit LED Display and Fault Reset
- Remote Keypad • RSLogix 5000 • Studio 5000 • DriveTools SP
- Connected Components Workbench (CCW)
- Integral RS485 (Modbus RTU)
- Optional: DeviceNet, EtherNet/IP, PROFIBUS DP, ControlNet, LonWorks, Bluetooth
- Qty. 2 (1 bipolar voltage, 1 current)
- Qty. 1 (unipolar voltage or current)
- Qty. 1 (uses an Analog Input)
- Qty. 7 (24V DC, 5 programmable)
- Qty. 1 (form C)
- Qty. 2
- Internal IGBT
- Safe Torque-Off, SIL2, PLd, Cat3

Found on page 33

## PowerFlex 400 AC Drive



- Volts per Hertz
- Open Loop Speed Regulation
- N/A
- 2.2...37 kW • 3.0...50 Hp • 12...145 A
- 2.2...250 kW • 3.0...350 Hp • 6...460 A
- N/A
- N/A
- IP20, NEMA/UL Type Open, Frame C: -10 to 50 °C (14 to 122 °F)
- IP20, NEMA/UL Type Open, Frame D and up: -10 to 45 °C (14 to 113 °F)
- IP30, NEMA/UL Type Open, all frames: -10 to 45 °C (14 to 113 °F)
- External
- UL, CE, cUL, C-Tick
- 110% for 60 secs
- 0...320 Hz
- Local Keypad • Remote Keypad
- RSLogix 5000 • Studio 5000 • DriveTools SP
- Connected Components Workbench (CCW)
- Integral RS485 (Modbus RTU, Metasys N2, P1-FLN)
- Optional: DeviceNet, EtherNet/IP, PROFIBUS DP, ControlNet, LonWorks, BACnet, Bluetooth
- Qty. 2 (1 bipolar voltage or current, 1 unipolar voltage or current)
- Qty. 2 (unipolar voltage or current)
- Qty. 1 (uses an Analog Input)
- Qty. 7 (24V DC, 4 programmable)
- Qty. 2 (form C)
- Qty. 1
- No
- No

Found on page 36

# POWERFLEX AC DRIVES

## PowerFlex 70 AC Drive



## PowerFlex 700 AC Drive



## PowerFlex 700H AC Drive



### Motor Control

- Vector Control w/FORCE Technology with and without an encoder • Sensorless Vector Control
- Volts per Hertz

- Vector Control w/FORCE Technology with and without an encoder • Sensorless Vector Control
- Volts per Hertz • Adjustable Voltage Control

- Volts per Hertz
- Sensorless Vector Control

### Application

- Open Loop Speed Regulation
- Closed Loop Speed Regulation
- Precise Torque & Speed Regulation

- Open Loop Speed Regulation
- Closed Loop Speed Regulation
- Precise Torque & Speed Regulation
- Indexer Positioning

- Open Loop Speed Regulation

### Single-phase Input w/Derate

- Yes

- Yes

- Yes

### Ratings 200-240V

- 0.37...18.5 kW • 0.5...25 Hp • 2.2...70 A

- 0.37...75 kW • 0.5...100 Hp • 2.2...260 A

- N/A

### Ratings 400-480V

- 0.37...37 kW • 0.5...50 Hp • 1.1...72 A

- 0.37...500 kW • 0.5...700 Hp • 1.1...875 A

- 132...1600 kW • 200...2300 Hp • 261...2700 A

### Ratings 500-600V

- 0.37...37 kW • 0.5...50 Hp • 0.9...52 A

- 0.75...110 kW • 1...150 Hp • 1.7...144 A

- 160...2000 kW • 150...2400 Hp • 170...2250 A

### Ratings 690V

- N/A

- 45...132 kW • 50...150 Hp • 52...142 A

- 160...2000 kW • 150...2400 Hp • 170...2250 A

### Ambient Temperature Limit for Enclosure Types

- IP20, NEMA/UL Type 1: 0 to 50 °C (32 to 122 °F)
- Flange Mount: 0 to 50 °C (32 to 122 °F)
- IP66, NEMA/UL Type 4X/12 indoor: 0 to 40 °C (32 to 104 °F)

- IP20, NEMA/UL Type Open: Frames 0-6: 0 to 50 °C (32 to 122 °F), typical Frames 7-10: 0 to 40 °C (32 to 104 °F) for chassis 0 to 65 °C (32 to 149 °F) for control • NEMA/UL Type 1: Frames 0-6: 0 to 40 °C
- IP 00/NEMA Open/Flange = 40 °C (104 °F)

- IP 21/NEMA/UL Type 1
- Normal Duty = 0-40 °C (32-104 °F)
- Heavy Duty = 0-40 °C (32-104 °F)

### EMC Filters

- Internal

- Internal (frame 0-6 only)

- Internal

### Standards and Certifications

- c-UL-us, CE, C-Tick, Lloyds Registry, ABS, EPRI/SEMI F47, TÜV FS ISO/EN13849-1 (EN954-1) with Safe Torque-Off option

- c-UL-us, CE, C-Tick, Lloyds Registry\*, ABS\*, EPRI/ SEMI F47\*, ATEX

\*Does not apply to frames 7-10

- UL, CE, cUL, C-Tick
- ATEX with Safe Torque-Off option
- TÜV FS ISO/EN13849-1 (EN954-1)

### Overload Capability

- Normal Duty Application • 110% - 60 s, 150% - 3 s
- Heavy Duty Application • 150% - 60 s, 200% - 3 s

- Normal Duty Application • 110% - 60 s, 150% - 3 s
- Heavy Duty Application • 150% - 60 s, 200% - 3 s

- Normal Duty Application • 110% - 60 s
- Heavy Duty Application • 150% - 60s, 200% - 2 s\*

\*Limits Apply

### Output Frequency Range

- 0 - 500 Hz

- 0 - 420 Hz

- 0 - 320 Hz

### User Interface

- Local PowerFlex HIMs
- Remote PowerFlex HIMs
- RSLogix 5000 • Studio 5000 • DriveTools SP
- Connected Components Workbench (CCW)

- Local PowerFlex HIMs
- Remote PowerFlex HIMs
- RSLogix 5000 • Studio 5000 • DriveTools SP
- Connected Components Workbench (CCW)

- Local PowerFlex HIMs
- Remote PowerFlex HIMs
- RSLogix 5000 • Studio 5000 • DriveTools SP
- Connected Components Workbench (CCW)

### Communications Options

- Internal DPI • DeviceNet • ControlNet (Coax or Fiber)
- EtherNet/IP • Remote I/O • RS485 DF1 • BACnet
- RS485 HVAC (Modbus RTU, Metasys N2, Siemens P1)
- PROFIBUS DP • Interbus • Bluetooth • External SCANport
- Modbus/TCP • CANopen • LonWorks

- Internal DPI • DeviceNet • ControlNet (Coax or Fiber)
- EtherNet/IP • Remote I/O • RS485 DF1 • BACnet
- RS485 HVAC (Modbus RTU, Metasys N2, Siemens P1)
- PROFIBUS DP • Interbus • Bluetooth • Modbus/TCP
- CANopen • LonWorks

- Internal DPI • DeviceNet • ControlNet (Coax or Fiber)
- EtherNet/IP • Remote I/O • RS485 DF1 • BACnet
- RS485 HVAC (Modbus RTU, Metasys N2, Siemens P1)
- PROFIBUS DP • Interbus • Bluetooth • Modbus/TCP
- CANopen • LonWorks

### Conformal Coating

- Option

- Option

- Option

### Analog Inputs

- Qty. 2 (1 bipolar voltage or current, 1 unipolar voltage or current)

- Qty. 2 (bipolar voltage or current)

- Qty. 2 (bipolar voltage or current)

### Analog Outputs

- Qty. 1 (unipolar voltage or current)

- Qty. 2 (bipolar voltage or current)

- Qty. 2 (bipolar voltage or current)

### PTC Inputs

- Qty. 1 (uses an Analog Input)

- Qty. 1 (dedicated)

- Qty. 1 (uses an Analog Input)

### Digital Inputs

- Qty. 6 (24V DC or 115V AC, option card required for 115V)

- Qty. 6 (24V DC or 115V AC)

- Qty. 6 (24V DC or 115V AC)

### Relay Outputs

- Qty. 2 (form C)

- Qty. 3 (1 form A, 1 form B, 1 form C)

- Qty. 3 (1 form A, 1 form B, 1 form C)

### Transistor Outputs

- None

- None

- None

### Internal Brake Transistor

- Standard

- Standard on Frame 0-3, Optional on Frame 4-6

- Optional (frame 9 only)

### AC Input Choke

- No

- No

- Yes

### DC Link Choke

- FR C-E Yes

- Yes

- No

### Common Mode Choke

- External option

- Internal (frame 0-6 only)

- Internal

### Integrated Safety

- Safe Torque-Off SIL, PLd, Cat 3

- No

- Safe Torque-Off SIL, PLd, Cat 3

Found on page 57

Found on page 64

Found on page 70

## PowerFlex 700S AC Drive



- Vector Control w/FORCE Technology with and without an encoder • Volts per Hertz
- Permanent Magnet Motor Control

- Closed Loop Speed Regulation
- Precise Torque Regulation
- Precise Torque & Speed Regulation
- Accurate Positioning

• Yes

• 0.75...66 kW • 1...100 Hp • 4.2...260 A

• 0.75...800 kW • 1...1250 Hp • 2.1...1450 A

• 75...1500 kW • 1...1600 Hp • 1.7...1500 A

• 75...1500 kW • 75...1600 Hp • 77...1500 A

- IP20, NEMA/UL Type Open: 0 to 50 °C (32 to 122 °F)
- IP21, NEMA/UL Type 1: 0 to 40 °C (32 to 104 °F)

• Internal

- UL, CE, cUL, C-Tick, RINA\*
- TUV FS ISO/EN13849-1 (EN954-1)

\* Applies to frames 1-6

- Normal Duty Application • 110% - 60 s, 150% - 3 s
- Heavy Duty Application • 150% - 60s, 200% - 3 s

• 0 - 400 Hz (Frames 1-6) • 0 - 320 Hz (Frames 9-14)

- Local PowerFlex HIMs
- Remote PowerFlex HIMs
- RSLogix 5000 • Studio 5000 • DriveTools SP
- Connected Components Workbench (CCW)

- Internal DPI • DeviceNet • ControlNet (Coax or Fiber)
- EtherNet/IP • Remote I/O • RS485 DF1
- RS485 HVAC (Modbus RTU, Metasys N2, Siemens P1) • PROFIBUS DP
- Interbus • Bluetooth

• Qty. 3 (2 bipolar voltage or current, 1 unipolar voltage)

• Qty. 2 (bipolar voltage or current)

• Qty. 1 (uses an Analog Input)

• Qty. 6 (3 - 24V DC or 115V AC, 3 - 24V DC)

• Qty. 1 (form C)

• Qty. 2

• Standard (frames 1-6) Optional (frame 9)

• Frames 1-6 No, Frames 9-14 Yes

• Frames 1-6 No, Frames 9-14 Yes

• Internal (Frame 1-9 only)

• Safe Torque-Off SIL, PLd, Cat 3

**Found on page 75**

## PowerFlex 700L AC Drive



- Available with PowerFlex 700 Vector Control or PowerFlex 700S Phase II Control boards

- Open Loop Speed Regulation
- Closed Loop Speed Regulation
- Precise Torque & Speed Regulation

• No

• N/A

• 200...715 kW • 300...1150 Hp • 360...1250 A

• 345...650 kW • 465...870 Hp • 425...800 A

• 355...657 kW • 475...881 Hp • 380...705 A

- IP00, NEMA/UL Type Open (frame 2): 0 to 50 °C (32 to 122 °F)
- IP20, NEMA/UL Type 1 (frame 3A and 3B): 0 to 40 °C (32 to 104 °F)

• Internal

- c-UL-us, CE, TÜV FS ISO/EN13849-1 (EN954-1) with PowerFlex 700S control

- Normal Duty Application • 110% - 60 s, 150% - 3s
- Heavy Duty Application • 150% - 60 s, 200% - 3 s

• Output frequency dependant on control boards

- Local PowerFlex HIMs
- Remote PowerFlex HIMs
- RSLogix 5000 • Studio 5000 • DriveTools SP
- Connected Components Workbench (CCW)

- See PowerFlex 700 or 700S – based on control version

• See PowerFlex 700 or 700S – based on control version

• Integral Regenerative capability

• Yes

• No

• External option

- Safe Torque-Off SIL, PLd, Cat 3 (with 700S control)

**Found on page 81**

## PowerFlex 753 AC Drive



- Vector Control w/FORCE Technology with or without an encoder • Sensorless Vector Control • Volts per Hertz
- Permanent Magnet Motor Control (Interior)

- Open Loop Speed Regulation • Closed Loop Speed Regulation • Precise Torque Regulation • Precise Torque & Speed Regulation • Indexer Positioning

• Yes

• N/A

• 0.75...250 kW • 1...350 Hp • 2.1...456 A

• 1...300 Hp • 1.7... 289 A

• 7.5...250 kW • 12...263 A

- IP00/IP10/IP20, NEMA/UL Open Type = 0-50 °C (32-122 °F) • Flange Mount Front: IP00/IP20, NEMA/UL Open Type = 0-50 °C (32-122 °F) • Flange Mount Back: IP66, NEMA/UL Type 4X = 0-40 °C (32-104 °F)
- IP54, NEMA/UL Type 12 = 0-40 °C (32-104 °F)

• Internal

- UL, CE, cUL, C-Tick, SEMI F47, GOST-R
- TÜV FS ISO/EN13849-1 (EN954-1) for Safe Torque-Off and Safe Speed Monitor options • ROHS compliant materials • Conformal Coating standard • ABS • Lloyd's Register • ATEX\*

- Normal Duty Application • 110% - 60 s, 150% - 3 s
- Heavy Duty Application • 150% - 60s, 180% - 3s

• 0...325 Hz @ 2 kHz PWM • 0...650 Hz @ 4 kHz PWM

- Local PowerFlex 750 Series HIMs
- Remote PowerFlex 750 Series HIMs
- RSLogix 5000 • Studio 5000 • DriveTools SP
- Connected Components Workbench (CCW)

- Single or Dual-port Ethernet/IP options
- ControlNet (Coax or Fiber) • DeviceNet
- Remote I/O • RS485 DF1 • PROFIBUS DP • BACnet/IP
- Modbus/TCP • HVAC (Modbus RTU, FLN P1, Metasys N2) • Bluetooth • LonWorks • CANopen

• Standard

• Up to 7 total (bipolar voltage or current)

• Up to 7 total (bipolar voltage or current)

• Up to 3 total

• Up to 21 total (Qty. 21 - 24V DC or Qty. 19 - 115V AC)

• Up to 7 total

• Up to 7 total

• Standard (frames 2-5) Optional (frame 6-7)

• No

• Yes

• External option

- Safe Torque-Off SIL, PLe, Cat 3
- Safe Speed Monitor SIL, PLe, Cat 4

**Found on page 84**

## PowerFlex 755 AC Drive



- Vector Control w/FORCE Technology with and without an encoder • Sensorless Vector Control • Volts per Hertz
- Permanent Magnet Motor Control (Surface and Interior)

- Open Loop Speed Regulation • Closed Loop Speed Regulation • Precise Torque Regulation • Precise Torque & Speed Regulation • Accurate Positioning with PCAM, Indexer and Gearing

• Yes

• N/A

• 0.75...1400 kW • 1...2000 Hp • 2.1...2330 A

• 1...1500 Hp • 1.7...1530 A

• 7.5...1500 kW • 12...1485 A

- IP00/IP20, NEMA/UL Open Type = 0-50 °C (32-122 °F) • Flange Mount Front: IP00/IP20, NEMA/UL Open Type = 0-50 °C (32-122 °F) • Flange Mount Back: IP66, NEMA/UL Type 4X = 0-40 °C (32-104 °F)
- IP54, NEMA/UL Type 12 = 0-40 °C (32-104 °F)

• Internal

- UL, CE, cUL, C-Tick, SEMI F47, GOST-R • TÜV FS ISO/EN13849-1 (EN954-1) for Safe Torque-Off and Safe Speed Monitor options • ROHS compliant materials • Conformal Coating standard • ABS (Frames 2...8) • Lloyd's Register (Frames 2...8) • ATEX\*

- Light Duty Application (frames 8 and larger) • 110% - 60s
- Normal Duty Application • 110% - 60s, 150% - 3s
- Heavy Duty Application • 150% - 60s, 180% - 3s

• 0...325 Hz @ 2 kHz PWM • 0...650 Hz @ 4 kHz PWM

- Local PowerFlex 750 Series HIMs
- Remote PowerFlex 750 Series HIMs
- RSLogix 5000 • Studio 5000 • DriveTools SP • Studio 5000 Embedded Instructions • Connected Components Workbench (CCW)

- Embedded EtherNet/IP port or Dual-port EtherNet/IP option module • CIP Motion • ControlNet (Coax or Fiber) • DeviceNet
- Remote I/O • BACnet/IP • RS485 DF1 • PROFIBUS DP
- Modbus/TCP • HVAC (Modbus RTU, FLN P1, Metasys N2) • Bluetooth • LonWorks • CANopen

• Standard

• Up to 10 total (bipolar voltage or current)

• Up to 10 total (bipolar voltage or current)

• Up to 5 total

• Up to 31 total (24V DC or 115V AC)

• Up to 10 total (form C)

• Up to 10 total

• Standard (frames 2-5) Optional (frame 6-7)

• No

• Yes

• External option

- Safe Torque-Off SIL, PLe, Cat 3
- Safe Speed Monitor SIL, PLe, Cat 4

**Found on page 91** \*Requires 11-Series I/O and ATEX daughter card options



# PowerFlex 4M AC Drive

Providing users with powerful motor speed control in a compact, space saving design, the PowerFlex 4M AC drive is the smallest and most cost effective member of the PowerFlex family of drives.

Providing application flexibility, feed-through wiring and ease-of-programming this drive is ideal for machine level speed control, for applications requiring space savings and easy-to-use AC drives.

## PowerFlex 4M at a glance

### Ratings

100...120V:	0.2...1.1 kW / 0.25...1.5 Hp / 1.6...6 A
200...240V:	0.2...7.5 kW / 0.25...10 Hp / 1.6...33 A
380...480V:	0.4...11 kW / 0.5...15 Hp / 1.5...24 A

**Motor Control** V/Hz Control

**Enclosures** IP20, NEMA/UL Type Open

- Certifications**
- C-Tick
  - c-UL, UL
  - CE
  - RoHS

**Options** See pages 39...45

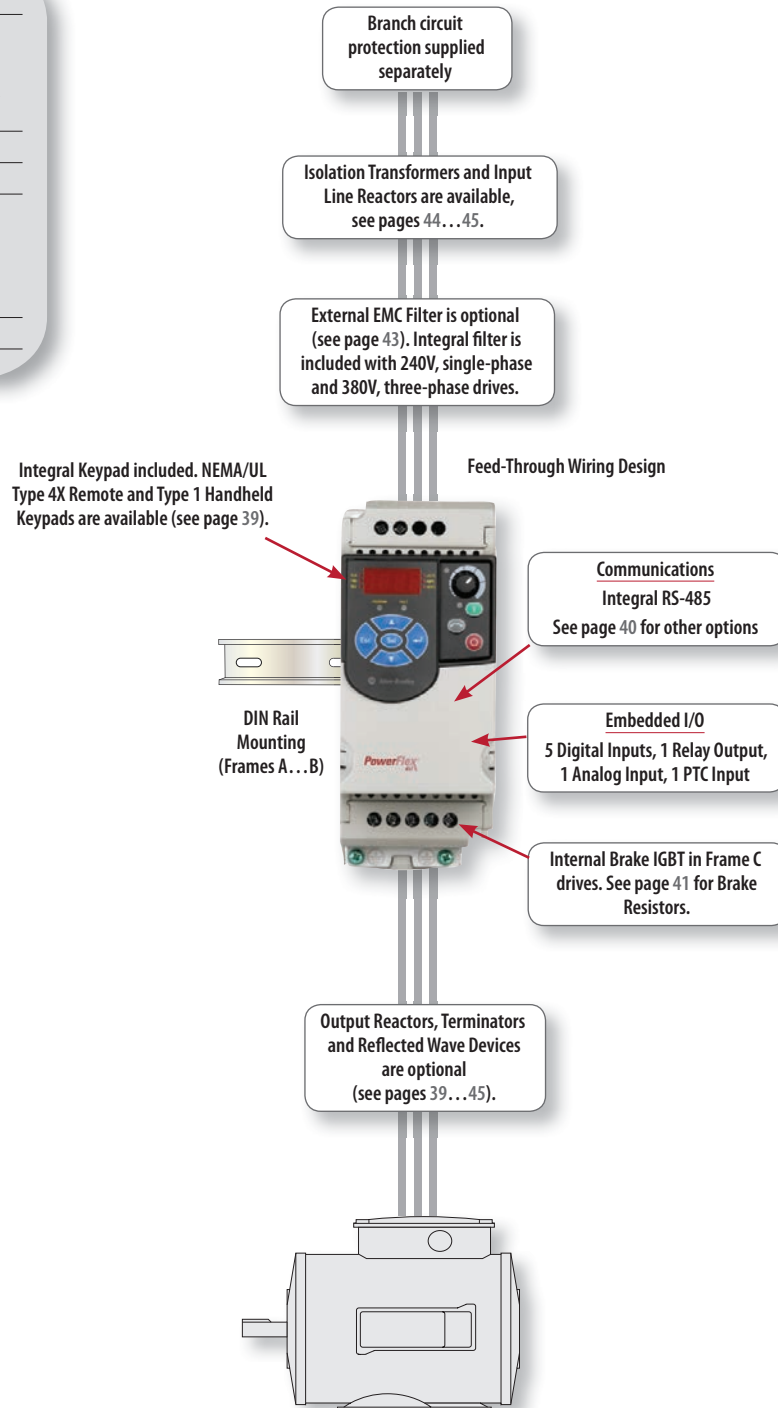

## Additional Information

PowerFlex 4M Technical Data, publication 22F-TD001

PowerFlex 4M User Manual, publication 22F-UM001

## Catalog Number Explanation

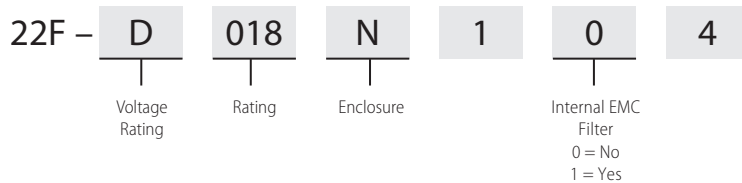

## Product Selection

### 100...120V AC, Single-Phase Drives (50/60 Hz, No Brake)

Drive Ratings			Frame Size	IP20, NEMA/UL Type Open	with Integral "S Type" EMC Filter
kW	Hp	Output Current A		Cat. No.	Cat. No.
0.2	0.25	1.6	A	22F-V1P6N103	–
0.4	0.5	2.5	A	22F-V2P5N103	–
0.75	1	4.5	B	22F-V4P5N103	–
1.1	1.5	6	B	22F-V6P0N103	–

### 200...240V AC, Single-Phase Drives (50/60 Hz, No Brake)

Drive Ratings			Frame Size	IP20, NEMA/UL Type Open	with Integral "S Type" EMC Filter ‡
kW	Hp	Output Current A		Cat. No.	Cat. No.
0.2	0.25	1.6	A	22F-A1P6N103	22F-A1P6N113
0.4	0.5	2.5	A	22F-A2P5N103	22F-A2P5N113
0.75	1	4.2	A	22F-A4P2N103	22F-A4P2N113
1.5	2	8	B	22F-A8P0N103	22F-A8P0N113
2.2	3	11	B	22F-A011N103	22F-A011N113

‡ This filter is suitable for use with a cable length of up to 5 meters for class A environments and up to 1 meter for class B environments.

**200...240V AC, Three-Phase Drives (50/60 Hz)**

Drive Ratings				IP20, NEMA/UL Type Open	with Integral "S Type" EMC Filter
kW	Hp	Output Current	Frame Size	Cat. No.	Cat. No.
		A			
0.2	0.25	1.6	A	22F-B1P6N103	--
0.4	0.5	2.5	A	22F-B2P5N103	--
0.75	1	4.2	A	22F-B4P2N103	--
1.5	2	8	A	22F-B8P0N103	--
2.2	3	12	B	22F-B012N103	--
3.7	5	17.5	B	22F-B017N103	--
<b>with Brake</b>					
5.5	7.5	25	C	22F-B025N104	--
7.5	10	33	C	22F-B033N104	--

**380...480V AC, Three-Phase Drives (50/60 Hz)**

Drive Ratings				IP20, NEMA/UL Type Open	with Integral "S Type" EMC Filter ‡
kW	Hp	Output Current	Frame Size	Cat. No.	Cat. No.
		A			
0.4	0.5	1.5	A	22F-D1P5N103	22F-D1P5N113
0.75	1	2.5	A	22F-D2P5N103	22F-D2P5N113
1.5	2	4.2	A	22F-D4P2N103	22F-D4P2N113
2.2	3	6	B	22F-D6P0N103	22F-D6P0N113
3.7	5	8.7	B	22F-D8P7N103	22F-D8P7N113
<b>with Brake</b>					
5.5	7.5	13	C	22F-D013N104	22F-D013N114
7.5	10	18	C	22F-D018N104	22F-D018N114
11	15	24	C	22F-D024N104	22F-D024N114

‡ This filter is suitable for use with a cable length of up to 10 meters for Class A environments.

**Approximate Dimensions and Weights**

Dimensions are in mm (in.) - weights are in kg (lb)

**IP20, NEMA/UL Type Open**

Frame	H	W	D	Weight
A	174.0 (6.85)	72.0 (2.83)	136.0 (5.35)	1.58 (3.5)
B	174.0 (6.85)	100.0 (3.94)	136.0 (5.35)	2.09 (4.6)
C	260.0 (10.24)	130.0 (5.12)	180.0 (7.09)	4.81 (10.6)

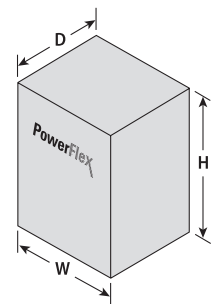



# PowerFlex 4 AC Drive

Designed to meet global OEM and end-user demands for simplicity, space savings, and cost efficiency, this drive provides intuitive features such as an integral keypad with local potentiometer and control keys that are active right out of the box.

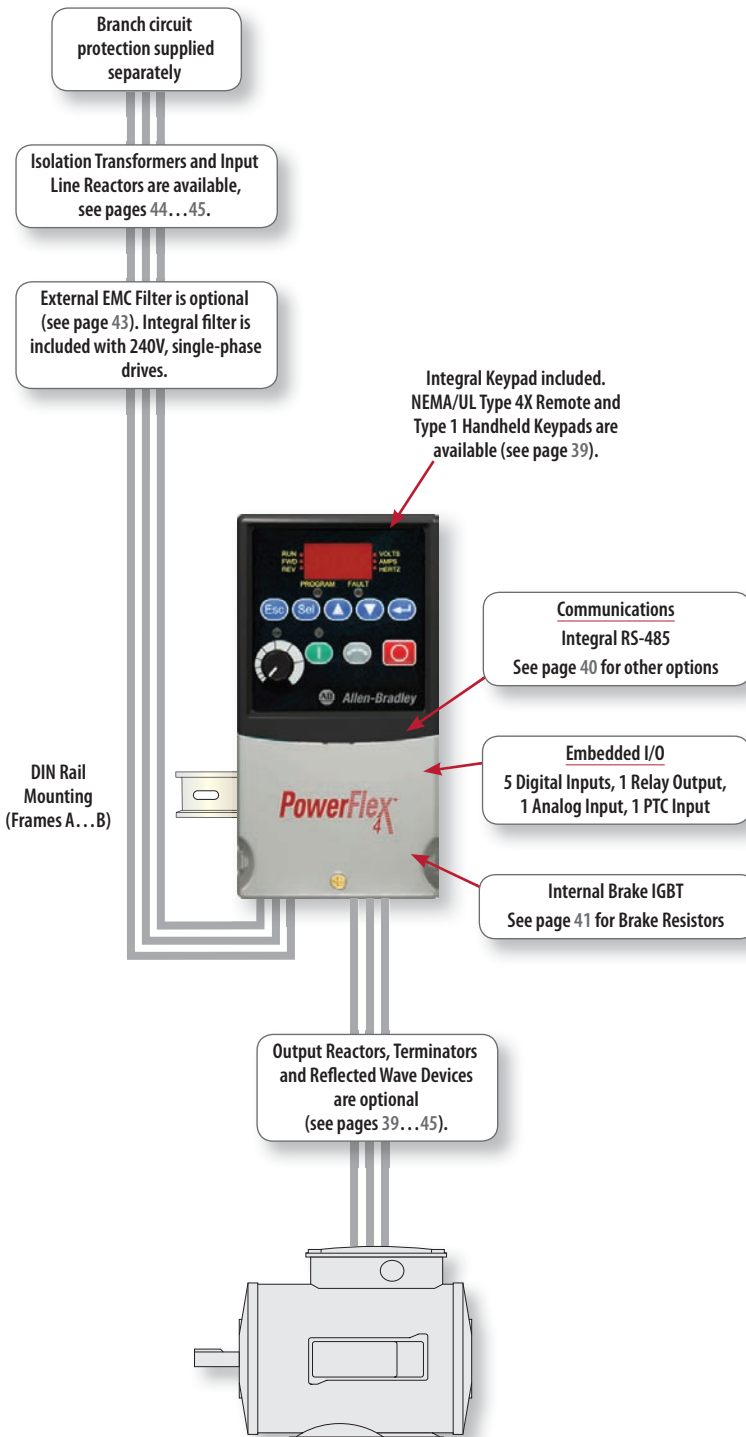

## PowerFlex 4 at a glance

### Ratings

100...120V:	0.2...1.1 kW / 0.25...1.5 Hp / 1.5...6 A
200...240V:	0.2...3.7 kW / 0.25...5 Hp / 1.4...17.5 A
380...480V:	0.4...3.7 kW / 0.5...5 Hp / 1.4...8.7 A

### Motor Control

V/Hz Control

### Enclosures

- IP20, NEMA/UL Type Open
- Plate Drive  
Front = IP20, NEMA/UL Type Open
- Flange Mount  
Front = IP20, NEMA/UL Type Open,  
Back/Heatsink = IP40/54/65,  
NEMA/UL Type 1/12/4/4X
- IP30, NEMA/UL Type 1 (with optional kit)

### Certifications

- C-Tick
- c-UL, UL
- CE
- RoHS

### Options

See pages 39...45

## Additional Information

PowerFlex 4/40 Technical Data, publication 22-TD001

PowerFlex 4 User Manual, publication 22A-UM001

## Catalog Number Explanation

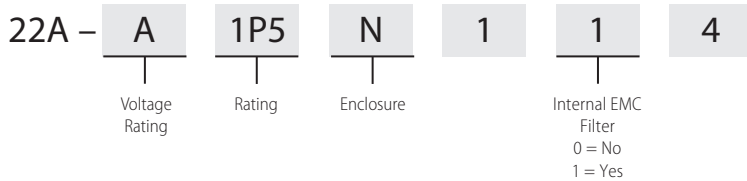

## Product Selection

### 100...120V AC, Single-Phase Drives (50/60 Hz, No Filter)

Drive Ratings				IP20/NEMA Type Open	IP20 Plate Drive §	IP20 Flange Mount ★
kW	Hp	Output Current	Frame Size	Cat. No.	Cat. No.	Cat. No.
		A				
0.2	0.25	1.5	A	22A-V1P5N104	22A-V1P5H204	22A-V1P5F104
0.4	0.5	2.3	A	22A-V2P3N104	22A-V2P3H204	22A-V2P3F104
0.75	1	4.5	B	22A-V4P5N104	22A-V4P5H204	22A-V4P5F104
1.1	1.5	6	B	22A-V6P0N104	22A-V6P0H204	22A-V6P0F104

§ Plate Drive – Front = IP20, NEMA/UL Type Open.

★ Flange Mount – Front = IP20, NEMA/UL Type Open, Back/Heatsink = IP40/54/65, NEMA/UL Type 1/12/4/4X.

### 200...240V AC, Single-Phase Drives (50/60 Hz, No Brake)

Drive Ratings				IP20/NEMA Type Open	IP20 Plate Drive §	IP20 Flange Mount ★
kW	Hp	Output Current	Frame Size	Cat. No.	Cat. No.	Cat. No.
		A				
<b>with Integral "S Type" EMC Filter ‡</b>						
0.2	0.25	1.4	A	22A-A1P4N113	–	–
0.4	0.5	2.1	A	22A-A2P1N113	–	–
0.75	1	3.6	A	22A-A3P6N113	–	–
1.5	2	6.8	B	22A-A6P8N113	–	–
2.2	3	9.6	B	22A-A9P6N113	–	–
<b>No Filter</b>						
0.2	0.25	1.4	A	22A-A1P4N103	–	–
0.4	0.5	2.1	A	22A-A2P1N103	–	–
0.75	1	3.6	A	22A-A3P6N103	–	–
1.5	2	6.8	B	22A-A6P8N103	–	–
2.2	3	9.6	B	22A-A9P6N103	–	–

§ Plate Drive – Front = IP20, NEMA/UL Type Open.

★ Flange Mount – Front = IP20, NEMA/UL Type Open, Back/Heatsink = IP40/54/65, NEMA/UL Type 1/12/4/4X.

‡ This filter is suitable for use with a cable length of up to 10 meters for Class A and 1 meter for Class B environments.

## 200...240V AC, Single-Phase Drives (50/60 Hz)

Drive Ratings				IP20/NEMA Type Open	IP20 Plate Drive §	IP20 Flange Mount ★
kW	Hp	Output Current	Frame Size	Cat. No.	Cat. No.	Cat. No.
		A				
<b>with Integral "S Type" EMC Filter ‡</b>						
0.2	0.25	1.5	A	22A-A1P5N114	–	–
0.4	0.5	2.3	A	22A-A2P3N114	–	–
0.75	1	4.5	A	22A-A4P5N114	–	–
1.5	2	8	B	22A-A8P0N114	–	–
<b>No Filter</b>						
0.2	0.25	1.5	A	22A-A1P5N104	22A-A1P5H204	22A-A1P5F104
0.4	0.5	2.3	A	22A-A2P3N104	22A-A2P3H204	22A-A2P3F104
0.75	1	4.5	A	22A-A4P5N104	22A-A4P5H204	22A-A4P5F104
1.5	2	8	B	22A-A8P0N104	22A-A8P0H204	22A-A8P0F104

§ Plate Drive – Front = IP20, NEMA/UL Type Open.

★ Flange Mount – Front = IP20, NEMA/UL Type Open, Back/Heatsink = IP40/54/65, NEMA/UL Type 1/12/4/4X.

‡ This filter is suitable for use with a cable length of up to 10 meters for Class A and 1 meter for Class B environments.

## 200...240V AC, Three-Phase Drives (50/60 Hz, No Filter)

Drive Ratings				IP20/NEMA Type Open	IP20 Plate Drive §	IP20 Flange Mount ★
kW	Hp	Output Current	Frame Size	Cat. No.	Cat. No.	Cat. No.
		A				
0.2	0.25	1.5	A	22A-B1P5N104	22A-B1P5H204	22A-B1P5F104
0.4	0.5	2.3	A	22A-B2P3N104	22A-B2P3H204	22A-B2P3F104
0.75	1	4.5	A	22A-B4P5N104	22A-B4P5H204	22A-B4P5F104
1.5	2	8	A	22A-B8P0N104	22A-B8P0H204	22A-B8P0F104
2.2	3	12	B	22A-B012N104	22A-B012H204	22A-B012F104
3.7	5	17.5	B	22A-B017N104	22A-B017H204	22A-B017F104

§ Plate Drive – Front = IP20, NEMA/UL Type Open.

★ Flange Mount – Front = IP20, NEMA/UL Type Open, Back/Heatsink = IP40/54/65, NEMA/UL Type 1/12/4/4X.

## 380...480V AC, Three-Phase Drives (50/60 Hz, No Filter)

Drive Ratings				IP20/NEMA Type Open	IP20 Plate Drive §	IP20 Flange Mount ★
kW	Hp	Output Current	Frame Size	Cat. No.	Cat. No.	Cat. No.
		A				
0.4	0.5	1.4	A	22A-D1P4N104	22A-D1P4H204	22A-D1P4F104
0.75	1	2.3	A	22A-D2P3N104	22A-D2P3H204	22A-D2P3F104
1.5	2	4	A	22A-D4P0N104	22A-D4P0H204	22A-D4P0F104
2.2	3	6	B	22A-D6P0N104	22A-D6P0H204	22A-D6P0F104
3.7	5	8.7	B	22A-D8P7N104	22A-D8P7H204	22A-D8P7F104

§ Plate Drive – Front = IP20, NEMA/UL Type Open.

★ Flange Mount – Front = IP20, NEMA/UL Type Open, Back/Heatsink = IP40/54/65, NEMA/UL Type 1/12/4/4X.



## Approximate Dimensions and Weights

Dimensions are in mm (in.) - weights are in kg (lb)

### IP20, NEMA/UL Type Open

Frame	H	W	D	Weight
A	152.0 (5.98) 185.0 (7.28) ★	80.0 (3.15)	136.0 (5.35)	1.41 (3.1)
B	180.0 (7.09) 213.0 (8.39) ★	100.0 (3.94)	136.0 (5.35)	2.22 (4.9)

★ Overall height of drive with IP30, NEMA 1/UL Type 1 option kit installed.

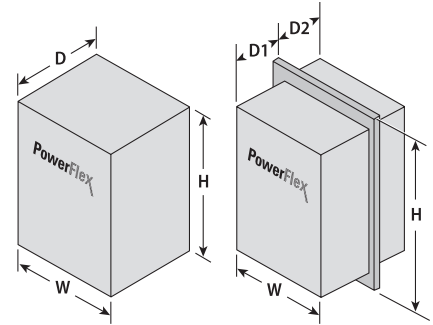

### Plate Drive

Frame	H	W	D	Weight
A	175.0 (6.89)	104.8 (4.13)	94.0 (3.70)	0.91 (2.0)
B	125.0 (4.92)	204.0 (8.03)	97.5 (3.84)	1.67 (3.7)

### Flange Mount

Frame	H	W	D1	D2	Weight
A	210.0 (8.27)	175.0 (6.89)	92.8 (3.65)	54.7 (2.15)	2.49 (5.5)
B	250.0 (9.84)	244.0 (9.61)	94.3 (3.71)	63.1 (2.48)	4.53 (10.0)

# PowerFlex 40 AC Drive

The PowerFlex 40 AC drive gives OEMs, machine builders and end users performance-enhancing motor control in an easy to-use, compact package. The PowerFlex 40 features sensorless vector control to meet low speed torque demands helping to improve application performance.

With flexible packaging options and an uncomplicated programming structure, this drive can be quickly and easily installed and configured for a variety of applications.

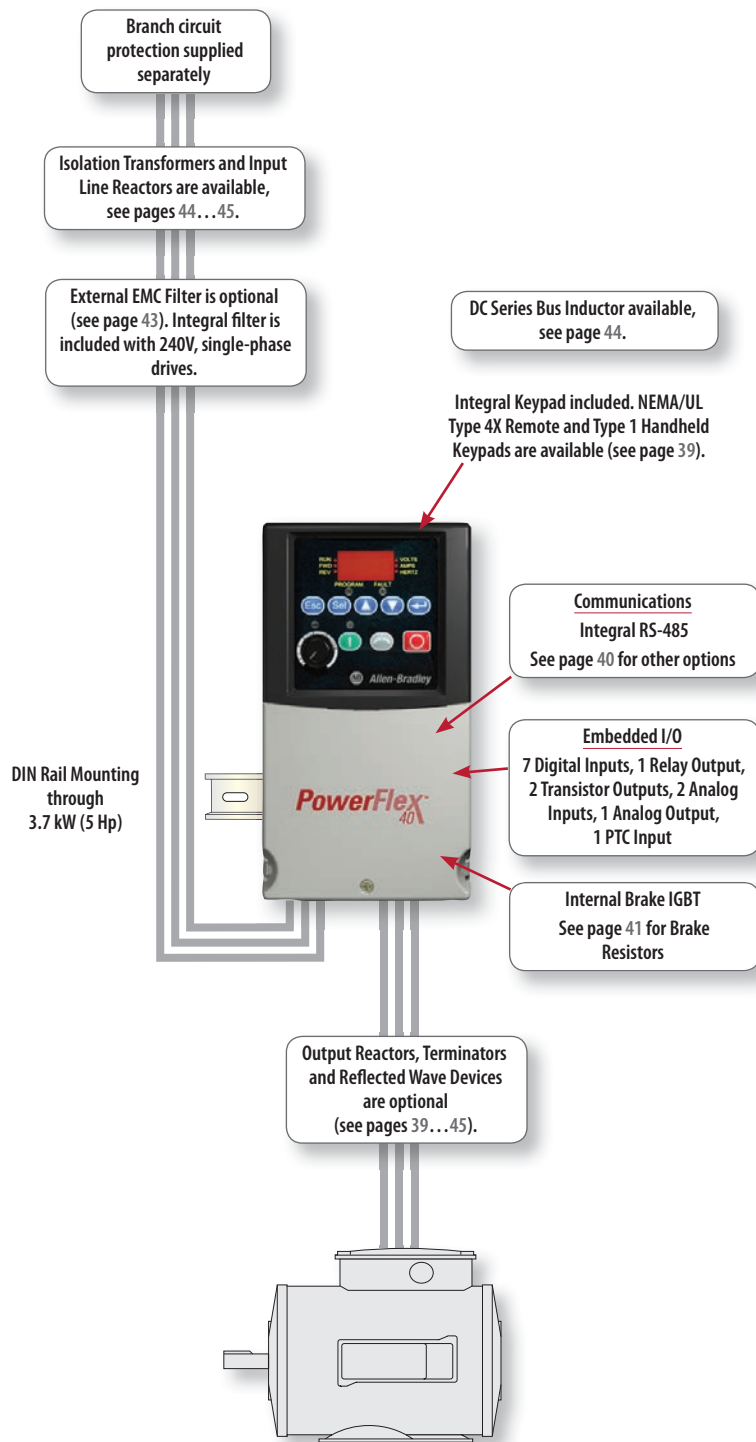

## PowerFlex 40 AC Drive at a glance

### Ratings

100...120V:	0.4...1.1 kW / 0.5...1.5 Hp / 2.3...6 A
200...240V:	0.4...7.5 kW / 0.5...10 Hp / 2.3...33 A
380...480V:	0.4...11 kW / 0.5...15 Hp / 1.4...24 A
500...600V:	0.75...11 kW / 1...15 Hp / 1.7...19 A

### Motor Control

- V/Hz Control
- Sensorless Vector Control

### Enclosures

- IP20, NEMA/UL Type Open
- Plate Drive Front = IP20, NEMA/UL Type Open
- Flange Mount Front = IP20, NEMA/UL Type Open, Back/Heatsink = IP40/54/65, NEMA/UL Type 1/12/4/4X
- IP66, NEMA/UL Type 4X
- IP30, NEMA/UL Type 1 (with optional kit)

### Certifications

- C-Tick
- c-UL, UL
- CE
- RoHS

### Options

See pages 39...45

## Additional Information

PowerFlex 4/40 Technical Data, publication 22-TD001

PowerFlex 40 User Manual, publication 22B-UM001

## Catalog Number Explanation

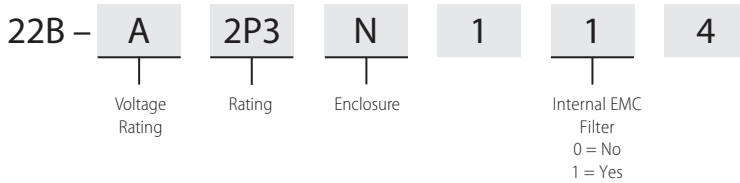

## Product Selection

### 100...120V AC, Single-Phase Drives (50/60 Hz, No Filter)

Drive Ratings				IP20, NEMA/UL Type Open	IP20 Plate Drive §	IP20 Flange Mount ★	IP66, NEMA/UL Type 4X
kW	Hp	Output Current	Frame Size	Cat. No.	Cat. No.	Cat. No.	Cat. No.
		A					
0.4	0.5	2.3	B	22B-V2P3N104	22B-V2P3H204	22B-V2P3F104	22B-V2P3C104
0.75	1	5	B	22B-V5PON104	22B-V5POH204	22B-V5POF104	22B-V5POC104
1.1	1.5	6	B	22B-V6PON104	22B-V6POH204	22B-V6POF104	22B-V6POC104

§ Plate Drive – Front = IP20, NEMA/UL Type Open.

★ Flange Mount – Front = IP20, NEMA/UL Type Open, Back/Heatsink = IP40/54/65, NEMA/UL Type 1/12/4/4X.

### 200...240V AC, Single-Phase Drives (50/60 Hz)

Drive Ratings				IP20, NEMA/UL Type Open	IP20 Plate Drive §	IP20 Flange Mount ★	IP66, NEMA/UL Type 4X
kW	Hp	Output Current	Frame Size	Cat. No.	Cat. No.	Cat. No.	Cat. No.
		A					
<b>with Integral "S Type" EMC Filter ‡</b>							
0.4	0.5	2.3	B	22B-A2P3N114	–	–	–
0.75	1	5	B	22B-A5PON114	–	–	–
1.5	2	8	B	22B-A8PON114	–	–	–
2.2	3	12	C	22B-A012N114	–	–	–
<b>No Filter</b>							
0.4	0.5	2.3	B	22B-A2P3N104	22B-A2P3H204	22B-A2P3F104	22B-A2P3C104
0.75	1	5	B	22B-A5PON104	22B-A5POH204	22B-A5POF104	22B-A5POC104
1.5	2	8	B	22B-A8PON104	22B-A8POH204	22B-A8POF104	22B-A8POC104
2.2	3	12	C	22B-A012N104	22B-A012H204	22B-A012F104	–

§ Plate Drive – Front = IP20, NEMA/UL Type Open.

★ Flange Mount – Front = IP20, NEMA/UL Type Open, Back/Heatsink = IP40/54/65, NEMA/UL Type 1/12/4/4X.

‡ This filter is suitable for use with a cable length of up to 10 meters for Class A and 1 meter for Class B environments.



**200...240V AC, Three-Phase Drives (50/60 Hz, No Filter)**

Drive Ratings				IP20, NEMA/UL Type Open	IP20 Plate Drive §	IP20 Flange Mount ★	IP66, NEMA/UL Type 4X
kW	Hp	Output Current	Frame Size	Cat. No.	Cat. No.	Cat. No.	Cat. No.
		A					
0.4	0.5	2.3	B	22B-B2P3N104	22B-B2P3H204	22B-B2P3F104	22B-B2P3C104
0.75	1	5	B	22B-B5P0N104	22B-B5P0H204	22B-B5P0F104	22B-B5P0C104
1.5	2	8	B	22B-B8P0N104	22B-B8P0H204	22B-B8P0F104	22B-B8P0C104
2.2	3	12	B	22B-B012N104	22B-B012H204	22B-B012F104	22B-B012C104
3.7	5	17.5	B	22B-B017N104	22B-B017H204	22B-B017F104	22B-B017C104
5.5	7.5	24	C	22B-B024N104	22B-B024H204	22B-B024F104	–
7.5	10	33	C	22B-B033N104	22B-B033H204	22B-B033F104	–

§ Plate Drive – Front = IP20, NEMA/UL Type Open.

★ Flange Mount – Front = IP20, NEMA/UL Type Open, Back/Heatsink = IP40/54/65, NEMA/UL Type 1/12/4/4X.

**380...480V AC, Three-Phase Drives (50/60 Hz, No Filter)**

Drive Ratings				IP20, NEMA/UL Type Open	IP20 Plate Drive §	IP20 Flange Mount ★	IP66, NEMA/UL Type 4X
kW	Hp	Output Current	Frame Size	Cat. No.	Cat. No.	Cat. No.	Cat. No.
		A					
0.4	0.5	1.4	B	22B-D1P4N104	22B-D1P4H204	22B-D1P4F104	22B-D1P4C104
0.75	1	2.3	B	22B-D2P3N104	22B-D2P3H204	22B-D2P3F104	22B-D2P3C104
1.5	2	4	B	22B-D4P0N104	22B-D4P0H204	22B-D4P0F104	22B-D4P0C104
2.2	3	6	B	22B-D6P0N104	22B-D6P0H204	22B-D6P0F104	22B-D6P0C104
4	5	10.5	B	22B-D010N104	22B-D010H204	22B-D010F104	22B-D010C104
5.5	7.5	12	C	22B-D012N104	22B-D012H204	22B-D012F104	–
7.5	10	17	C	22B-D017N104	22B-D017H204	22B-D017F104	–
11	15	24	C	22B-D024N104	22B-D024H204 ♣	22B-D024F104 ♣	–

§ Plate Drive – Front = IP20, NEMA/UL Type Open.

★ Flange Mount – Front = IP20, NEMA/UL Type Open, Back/Heatsink = IP40/54/65, NEMA/UL Type 1/12/4/4X.

♣ Requires use of external DC Bus inductor or AC Line Reactor.

**500...600V AC, Three-Phase Drives (50/60 Hz, No Filter)**

Drive Ratings				IP20, NEMA/UL Type Open	IP20 Plate Drive §	IP20 Flange Mount ★	IP66, NEMA/UL Type 4X
kW	Hp	Output Current	Frame Size	Cat. No.	Cat. No.	Cat. No.	Cat. No.
		A					
0.75	1	1.7	B	22B-E1P7N104	22B-E1P7H204	22B-E1P7F104	22B-E1P7C104
1.5	2	3	B	22B-E3P0N104	22B-E3P0H204	22B-E3P0F104	22B-E3P0C104
2.2	3	4.2	B	22B-E4P2N104	22B-E4P2H204	22B-E4P2F104	22B-E4P2C104
4	5	6.6	B	22B-E6P6N104	22B-E6P6H204	22B-E6P6F104	22B-E6P6C104
5.5	7.5	9.9	C	22B-E9P9N104	22B-E9P9H204	22B-E9P9F104	–
7.5	10	12	C	22B-E012N104	22B-E012H204	22B-E012F104	–
11	15	19	C	22B-E019N104	22B-E019H204	22B-E019F104	–

§ Plate Drive – Front = IP20, NEMA/UL Type Open.

★ Flange Mount – Front = IP20, NEMA/UL Type Open, Back/Heatsink = IP40/54/65, NEMA/UL Type 1/12/4/4X.

## Approximate Dimensions and Weights

Dimensions are in mm (in.) - weights are in kg (lb)

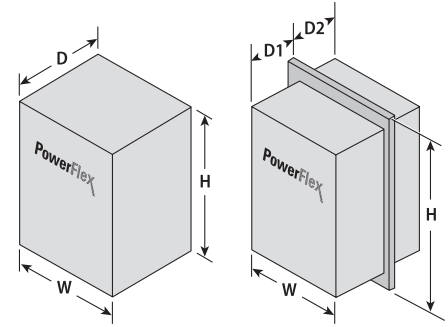

### IP20, NEMA/UL Type Open

Frame	H	W	D	Weight
B	180.0 (7.09)	100.0 (3.94)	136.0 (5.35)	2.22 (4.9)
	213.0 (8.39) ★		-	
	244.0 (9.61) ‡		161.0 (6.33) ‡	
C	260.0 (10.20)	130.0 (5.10)	180.0 (7.10)	4.31 (9.5)
	320.0 (12.60) ★		-	
	320.0 (12.60) ‡		205.0 (8.08) ‡	

★ Drive with IP30, NEMA 1/UL Type 1 option kit installed.

‡ Drive with IP30, NEMA 1/UL Type 1 option kit and Communication Option (22-JBCx) installed.

### Plate Drive

Frame	H	W	D	Weight
B	125.0 (4.92)	204.0 (8.03)	97.5 (3.84)	1.68 (3.7)
C	284.0 (11.18)	155.0 (6.10)	108.0 (4.25)	2.59 (5.7)

### IP66, NEMA/UL Type 4X/12

Frame	H	W	D	Weight
B	270.0 (10.63)	165.0 (6.50)	198.0 (7.80)	5.30 (11.7)

### Flange Mount

Frame	H	W	D1	D2	Weight
B	250.0 (9.84)	244.0 (9.61)	94.3 (3.71)	63.1 (2.48)	4.53 (10.0)
C	325.0 (12.80)	300.0 (11.81)	105.8 (4.17)	138.2 (5.44)	11.93 (26.3)

# PowerFlex 40P AC Drive

The PowerFlex 40P AC drive addresses user needs for closed loop control with an option for Category 3 Safe Torque-off in a compact and cost effective design. Based on the popular PowerFlex 40 this drive is designed to meet global OEM and end-user demands for flexibility, space savings and ease of use. This drive is a cost-effective alternative for speed or basic position control of applications such as diverters, smart conveyors, packaging machines, palletizers, drafting machines, ring spinning machines and synthetic fiber spinning machines and shares common options and accessories with the PowerFlex 40.

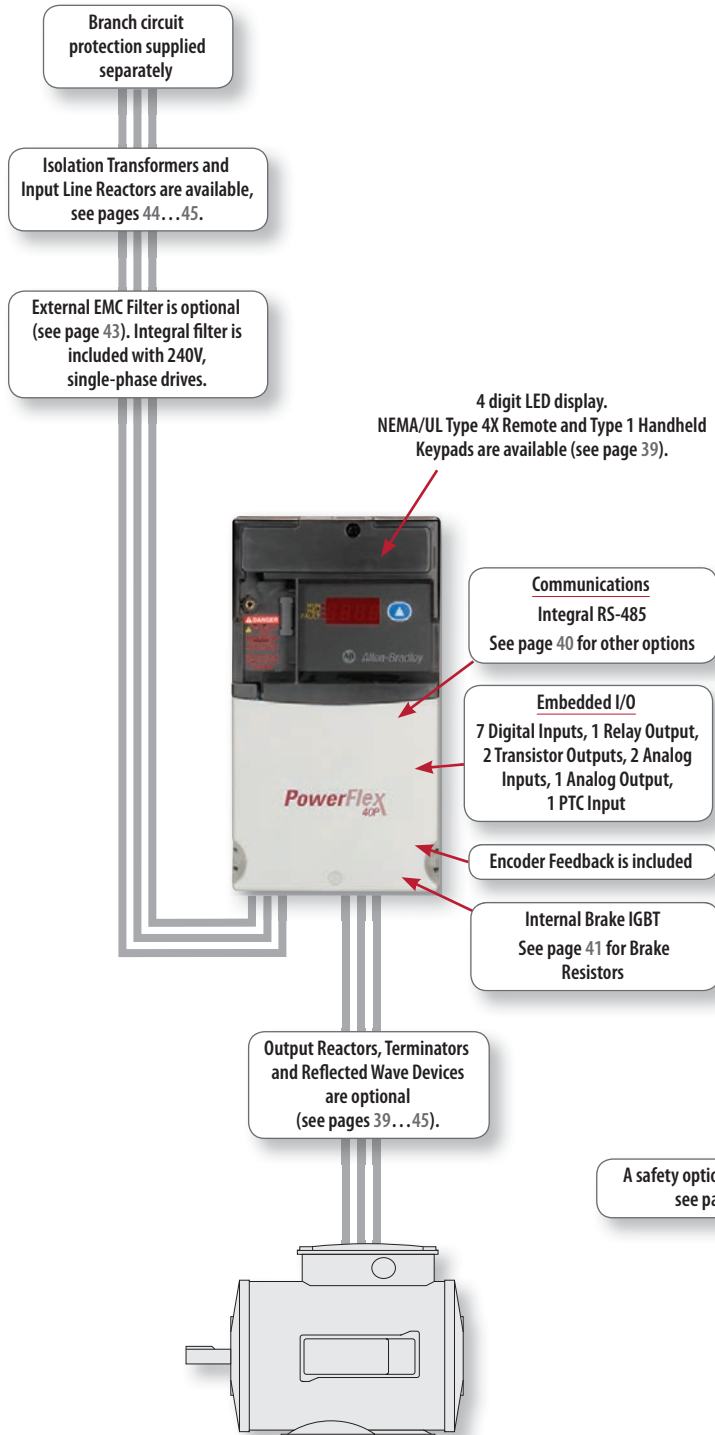

## PowerFlex 40P AC Drive at a glance

### Ratings

200...240V:	0.4...7.5 kW / 0.5...10 Hp / 2.3...33 A
380...480V:	0.4...11 kW / 0.5...15 Hp / 1.4...24 A
500...600V:	0.75...11 kW / 1...15 Hp / 1.7...19 A

### Motor Control

- V/Hz Control
- Sensorless Vector Control

### Enclosures

- IP20, NEMA/UL Type Open
- Plate Drive  
Front = IP20, NEMA/UL Type Open
- Flange Mount  
Front = IP20, NEMA/UL Type Open,  
Back/Heatsink = IP40/54/65,  
NEMA/UL Type 1/12/4/4X
- IP30, NEMA/UL Type 1 (with optional kit)

### Safety

DriveGuard Safe Torque-Off / EN 954-1 Cat. 3

### Additional Features

- Speed control with and without encoder feedback
- Fiber application specific features
- StepLogic allows operation as an independent position controller

### Certifications

- C-Tick
- c-UL, UL
- CE (240 and 480V Ratings)
- RoHS
- TÜV FS ISO/EN13849-1 (EN954-1) with Safe Torque-Off option

### Options

See pages 39...45



## Additional Information

PowerFlex 40P Technical Data, publication 22D-TD001

PowerFlex 40P User Manual, publication 22D-UM001

## Catalog Number Explanation



## Product Selection

### 200...240V AC, Three-Phase Drives (50/60 Hz, No Filter)

Drive Ratings				IP20/NEMA Type Open	IP20 Plate Drive §	IP20 Flange Mount ★
kW	Hp	Output Current	Frame Size	Cat. No.	Cat. No.	Cat. No.
		A				
0.4	0.5	2.3	B	22D-B2P3N104	22D-B2P3H204	22D-B2P3F104
0.75	1	5	B	22D-B5P0N104	22D-B5P0H204	22D-B5P0F104
1.5	2	8	B	22D-B8P0N104	22D-B8P0H204	22D-B8P0F104
2.2	3	12	B	22D-B012N104	22D-B012H204	22D-B012F104
3.7	5	17.5	B	22D-B017N104	22D-B017H204	22D-B017F104
5.5	7.5	24	C	22D-B024N104	22D-B024H204	22D-B024F104
7.5	10	33	C	22D-B033N104	22D-B033H204	22D-B033F104

§ Plate Drive – Front = IP20, NEMA/UL Type Open.

★ Flange Mount – Front = IP20, NEMA/UL Type Open, Back/Heatsink = IP40/54/65, NEMA/UL Type 1/12/4/4X.

### 380...480V AC, Three-Phase Drives (50/60 Hz, No Filter)

Drive Ratings				IP20/NEMA Type Open	IP20 Plate Drive §	IP20 Flange Mount ★
kW	Hp	Output Current	Frame Size	Cat. No.	Cat. No.	Cat. No.
		A				
0.4	0.5	1.4	B	22D-D1P4N104	22D-D1P4H204	22D-D1P4F104
0.75	1	2.3	B	22D-D2P3N104	22D-D2P3H204	22D-D2P3F104
1.5	2	4	B	22D-D4P0N104	22D-D4P0H204	22D-D4P0F104
2.2	3	6	B	22D-D6P0N104	22D-D6P0H204	22D-D6P0F104
4	5	10.5	B	22D-D010N104	22D-D010H204	22D-D010F104
5.5	7.5	12	C	22D-D012N104	22D-D012H204	22D-D012F104
7.5	10	17	C	22D-D017N104	22D-D017H204	22D-D017F104
11	15	24	C	22D-D024N104	22D-D024H204	22D-D024F104

§ Plate Drive – Front = IP20, NEMA/UL Type Open.

★ Flange Mount – Front = IP20, NEMA/UL Type Open, Back/Heatsink = IP40/54/65, NEMA/UL Type 1/12/4/4X.

## 500...600V AC, Three-Phase Drives (50/60 Hz, No Filter)

Drive Ratings			IP20/NEMA Type Open	IP20 Plate Drive §	IP20 Flange Mount ★	
kW	Hp	Output Current	Frame Size	Cat. No.	Cat. No.	Cat. No.
		A				
0.75	1	1.7	B	22D-E1P7N104	22D-E1P7H204	22D-E1P7F104
1.5	2	3	B	22D-E3P0N104	22D-E3P0H204	22D-E3P0F104
2.2	3	4.2	B	22D-E4P2N104	22D-E4P2H204	22D-E4P2F104
4	5	6.6	B	22D-E6P6N104	22D-E6P6H204	22D-E6P6F104
5.5	7.5	9.9	C	22D-E9P9N104	22D-E9P9H204	22D-E9P9F104
7.5	10	12	C	22D-E012N104	22D-E012H204	22D-E012F104
11	15	19	C	22D-E019N104	22D-E019H204	22D-E019F104

§ Plate Drive – Front = IP20, NEMA/UL Type Open.

★ Flange Mount – Front = IP20, NEMA/UL Type Open, Back/Heatsink = IP40/54/65, NEMA/UL Type 1/12/4/4X.

## Approximate Dimensions and Weights

Dimensions are in mm (in.) - weights are in kg (lb)

## IP20, NEMA/UL Type Open

Frame	H	W	D	Weight
B	180.0 (7.09)	100.0 (3.94)	136.0 (5.35)	2.22 (4.9)
	213.0 (8.39) ★		-	
	244.0 (9.61) ‡		161.0 (6.34) ‡	
C	260.0 (10.20)	130.0 (5.10)	180.0 (7.10)	4.31 (9.5)
	320.0 (12.60) ★		-	
	320.0 (12.60) ‡		205.0 (8.07) ‡	

★ Drive with IP30, NEMA 1/UL Type 1 option kit installed.

‡ Drive with IP30, NEMA 1/UL Type 1 option kit and Communication Option (22-JBCx) installed.

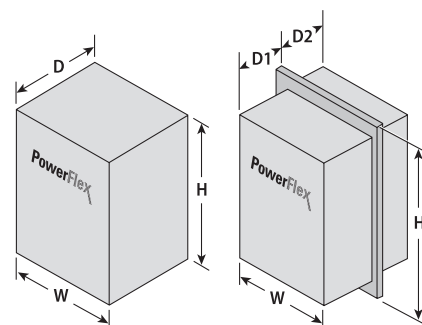

## Plate Drive

Frame	H	W	D	Weight
B	125.0 (4.92)	204.0 (8.03)	97.5 (3.84)	1.68 (3.7)
C	284.0 (11.18)	155.0 (6.10)	108.0 (4.25)	2.59 (5.7)

## Flange Mount

Frame	H	W	D1	D2	Weight
B	250.0 (9.84)	244.0 (9.61)	94.3 (3.71)	63.1 (2.48)	4.53 (10.0)
C	325.0 (12.80)	300.0 (11.81)	105.8 (4.17)	138.2 (5.44)	11.93 (26.3)

# PowerFlex 400 AC Drive

Providing users with easy installation and ideal for mechanical fan and pump systems, the PowerFlex 400 AC drive offers a wide range of built-in features allowing for seamless HVAC building system integration. The PowerFlex 400 is designed to meet global OEM, contractor and end-user demands for flexibility, space savings and ease-of-use..

## PowerFlex 400 AC Drive at a glance

### Ratings

200...240V: 2.2...37 kW / 3...50 Hp / 12...145 A  
 380...480V: 2.2...250 kW / 3...350 Hp / 6...460 A

### Motor Control

V/Hz Control

### Enclosures

- IP20, NEMA/UL Type Open
- Flange Mount
- Front = IP20, NEMA/UL Type Open, Back/Heatsink = IP40/54/65, NEMA/UL Type 1/12/4/4X
- IP30, NEMA/UL Type 1 (with optional kit)

### Additional Features

PID/ PIP for fan and pump applications

### Certifications

- C-Tick
- c-UL, UL
- CE
- IEC (Designed to Meet)
- RoHS
- UL508C Plenum Rating

### Options

See pages 39... 45

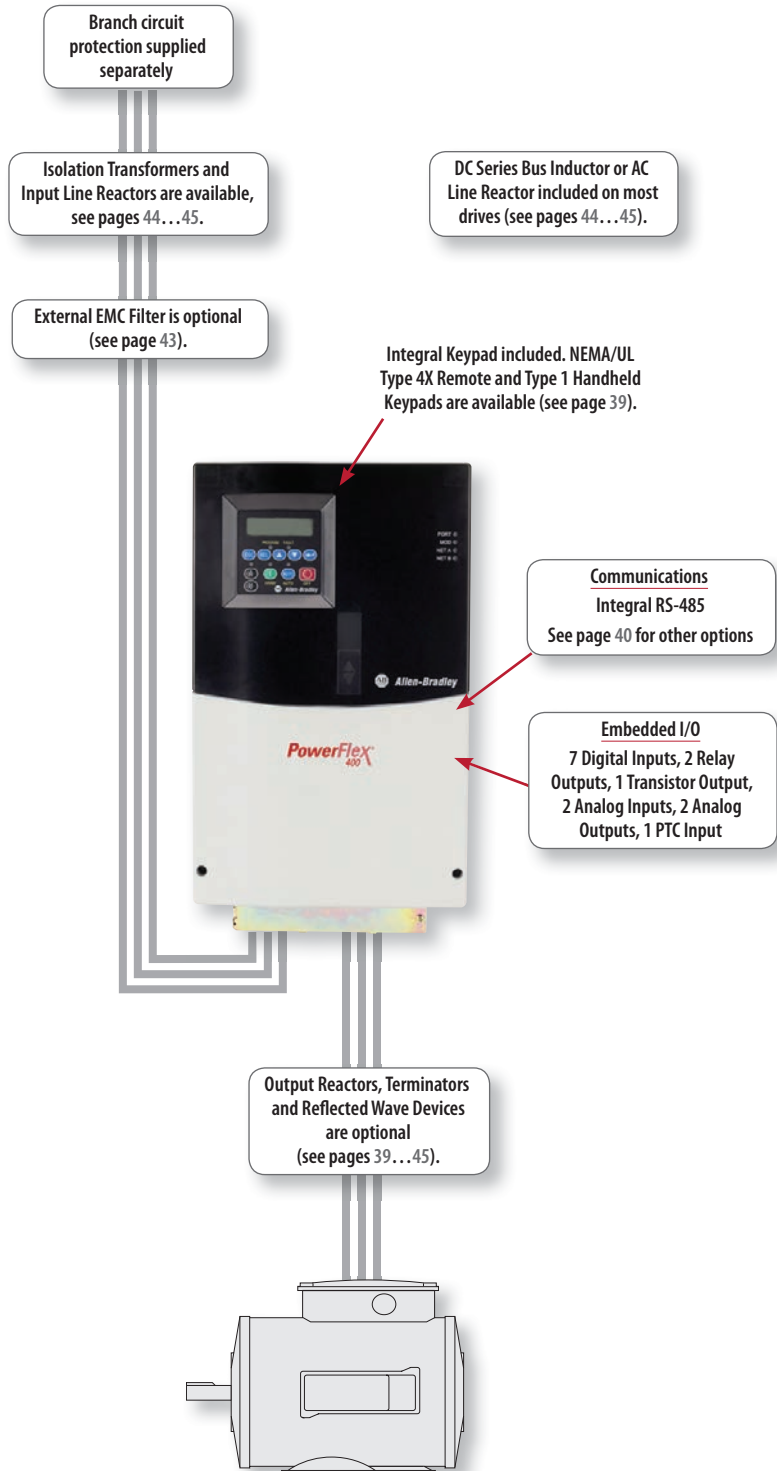





### 380...480V AC, Three-Phase Drives

Drive Ratings				Rating	Panel Mount	Flange Mount $\Delta$
kW	Hp	Output Current $\star$	Frame Size		Cat. No.	Cat. No.
		A				
2.2	3	6	C	IP20, NEMA/UL Open Type $\ddagger$	22C-D6PON103 $\clubsuit$	22C-D6POF103 $\clubsuit$
4	5	10.5	C	IP20, NEMA/UL Open Type $\ddagger$	22C-D010N103 $\clubsuit$	22C-D010F103 $\clubsuit$
5.5	7.5	12	C	IP20, NEMA/UL Open Type $\ddagger$	22C-D012N103 $\clubsuit$	22C-D012F103 $\clubsuit$
7.5	10	17	C	IP20, NEMA/UL Open Type $\ddagger$	22C-D017N103 $\clubsuit$	22C-D017F103 $\clubsuit$
11	15	22	C	IP20, NEMA/UL Open Type $\ddagger$	22C-D022N103	22C-D022F103 $\S$
15	20	30	C	IP20, NEMA/UL Open Type	22C-D030N103	22C-D030F103 $\S$
18.5	25	38	D	IP30, NEMA/UL Type 1	22C-D038A103	—
22	30	45.5	D	IP30, NEMA/UL Type 1	22C-D045A103	—
30	40	60	D	IP30, NEMA/UL Type 1	22C-D060A103	—
37	50	72	E	IP30, NEMA/UL Type 1	22C-D072A103	—
45	60	88	E	IP30, NEMA/UL Type 1	22C-D088A103	—
55	75	105	E	IP30, NEMA/UL Type 1	22C-D105A103	—
75	100	142	E	IP30, NEMA/UL Type 1	22C-D142A103	—
90	125	170	F	IP30, NEMA/UL Type 1	22C-D170A103	—
110	150	208	F	IP30, NEMA/UL Type 1	22C-D208A103	—
132	200	260	G	IP30, NEMA/UL Type 1	22C-D260A103	—
160	250	310	G	IP30, NEMA/UL Type 1	22C-D310A103	—
200	300	370	H	IP30, NEMA/UL Type 1	22C-D370A103 $\clubsuit$	—
250	350	460	H	IP30, NEMA/UL Type 1	22C-D460A103 $\clubsuit$	—

- $\star$  Drive terminals are sized according to UL. Depending on operating ambient and wire used, some local or national codes may require a larger wire size than what the power terminals can accept. Multiple conductors, 90 °C wire, and/or lugs may be required. Refer to the PowerFlex 400 User Manual for details on terminal block wire ranges.
- $\ddagger$  IP30, NEMA/UL Type 1 can be achieved for panel mount drives with top cover and optional conduit box kit installed. See page 40 for a field installed conversion kit.
- $\S$  11 and 15 kW (15 and 20 Hp) Frame C flange mount drives require an external DC series bus inductor.
- $\clubsuit$  200 and 250 kW (300 and 350 Hp) ratings include an internal AC line reactor (not a DC bus inductor).
- $\Delta$  Front = IP20, NEMA/UL Type Open, Back/Heatsink = IP40/54/65, NEMA/UL Type 1/12/4/4X.
- $\diamond$  A DC bus inductor is not included. See page 44 for available inductors.

## Approximate Dimensions and Weights

Dimensions are in mm (in.) - weights are in kg (lb)

### Panel Mount

Frame	H	W	D	Weight $\ddagger$
C	260.0 (10.20) 320.0 (12.60) $\star$	130.0 (5.10)	180.0 (7.10)	7.49 (16.5)
D	436.2 (17.17)	250.0 (9.84)	206.1 (8.11)	15.60 (34.4)
E	605.5 (23.84)	370.0 (14.57)	259.2 (10.21)	51.20 (112.9)
F	850.0 (33.46)	425.0 (16.73)	280.0 (11.02)	88.00 (194.0)
G	892.0 (35.12)	425.0 (16.73)	264.0 (10.39)	106.00 (233.7)
H	1363.8 (53.69)	529.2 (20.83)	358.6 (14.12)	177.00 (390.2)

- $\star$  Drive with IP30, NEMA 1/UL Type 1 option kit installed.
- $\ddagger$  Weights are approximate. Refer to the PowerFlex 400 User Manual for detailed weight information.

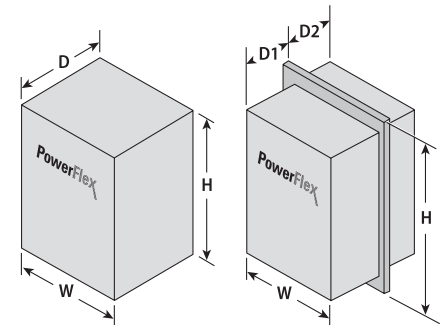

### Flange Mount

Frame	H	W	D1	D2	Weight $\ddagger$
C	325.0 (12.80)	300.0 (11.81)	105.8 (4.17)	138.2 (5.44)	3.85 (8.5)

- $\ddagger$  Weights are approximate. Refer to the PowerFlex 400 User Manual for detailed weight information.

# PowerFlex 4-Class Options

## Human Interface Modules and Accessories

Description	Cat. No.	Used with PowerFlex Drive				
		4M	4	40	40P	400
Remote (Panel Mount) LCD Display, Digital Speed Control, CopyCat Capable. Includes 2.0 meter cable. IP66, NEMA Type 4X/12 - Indoor Use Only.	22-HIM-C2S ☛	✓	✓	✓	✓	✓
Remote Handheld, LCD Display, Full Numeric Keypad, Digital Speed Control, CopyCat Capable. Includes 1.0 meter cable. IP30, NEMA Type 1. Panel mount with optional Bezel Kit.	22-HIM-A3	✓	✓	✓	✓	✓
Bezel Kit. Panel Mount for LCD Display, Remote Handheld Unit. IP30, NEMA Type 1. Includes a 22-RJ45CBL-C20 cable.	22-HIM-B1	✓	✓	✓	✓	✓
DSI HIM Cable (DSI HIM to RJ45 cable)						
1.0 Meter (3.3 Feet)	22-HIM-H10	✓	✓	✓	✓	✓
2.9 Meter (9.5 Feet)	22-HIM-H30	✓	✓	✓	✓	✓

☛ The 22-HIM-C2S is smaller than the 22-HIM-C2 and cannot be used as a direct replacement.

## Safety Options

Description	Cat. No.	Used with PowerFlex Drive				
		4M	4	40	40P	400
DriveGuard Safe Torque-Off	20A-DG01				✓	

## Other Options

Description	Cat. No.	Used with PowerFlex Drive				
		4M	4	40	40P	400
Auxiliary Relay Board - Expands drive output capabilities - Frames D...H only.	AK-U9-RLB1					✓

## Terminators

Description ★	Cat. No.	Used with PowerFlex Drive				
		4M	4	40	40P	400
for use with 3.7 kW (5 Hp) and below drives	1204-TFA1	✓	✓	✓	✓	✓
for use with 1.5 kW (2 Hp) and up drives	1204-TFB2	✓	✓	✓	✓	✓

★ For selection information, refer to Appendix A of the Wiring and Grounding Guidelines for Pulse Width Modulated (PWM) AC Drives, publication Drives-IN001.

## Reflected Wave Reduction Modules

Voltage	ND kW	ND Hp	Cat. No.	Used with PowerFlex Drive				
				4M	4	40	40P	400
380... 480V AC	2.2...4	3...5	1321-RWR8-DP	✓	✓	✓	✓	✓
	4	5	1321-RWR12-DP	✓		✓	✓	✓
	5.5	7.5	1321-RWR18-DP	✓		✓	✓	✓
	7.5	10	1321-RWR25-DP	✓		✓	✓	✓
	11	15	1321-RWR25-DP	✓		✓	✓	✓
	15	20	1321-RWR35-DP					✓
	18.5	25	1321-RWR45-DP					✓
	22	30	1321-RWR55-DP					✓
	30	40	1321-RWR80-DP					✓
	37	50	1321-RWR80-DP					✓
	45	60	1321-RWR100-DP					✓
	55	75	1321-RWR130-DP					✓
	75	100	1321-RWR160-DP					✓
500... 600V AC	90	125	1321-RWR200-DP					✓
	110	150	1321-RWR250-DP					✓
	149	200	1321-RWR320-DP					✓
	187	250	1321-RWR320-DP					✓
	4	5	1321-RWR8-EP			✓	✓	
	5.5	7.5	1321-RWR12-EP			✓	✓	
	7.5	10	1321-RWR18-EP			✓	✓	
	11	15	1321-RWR25-EP			✓	✓	

## Reflected Wave Reduction Module with Common Mode Choke

Description ★	Cat. No.	Used with PowerFlex Drive				
		4M	4	40	40P	400
17A with Common Mode Choke	1204-RWC-17-A	✓	✓	✓	✓	✓

★ For selection information, refer to Appendix A of the Wiring and Grounding Guidelines for Pulse Width Modulated (PWM) AC Drives, publication Drives-IN001.

**Communication Option Kits**

Description	Cat. No.	Used with PowerFlex Drive				
		4M	4	40	40P	400
BACnet® MS/TP RS485 Communication Adapter	22-COMM-B		✓ §	✓ △		✓
ControlNet™ Communication Adapter	22-COMM-C	✓ §	✓ §	✓ △	✓ △	✓
DeviceNet™ Communication Adapter	22-COMM-D	✓ §	✓ §	✓ △	✓ △	✓
EtherNet/IP™ Communication Adapter	22-COMM-E	✓ §	✓ §	✓ △	✓ △	✓
LonWorks® Communication Adapter	22-COMM-L		✓ §	✓ △	✓ △	✓
PROFIBUS™ DP Communication Adapter	22-COMM-P	✓ ‡	✓ ‡	✓ △	✓ △	✓
Serial Converter Module (RS485 to RS232). Provides serial communication via DF1 protocol for use with DriveExplorer and DriveExecutive™ software. Includes DSI to RS232 serial converter, 1203-SFC serial cable, 22-RJ45CBL-C20 cable, and DriveExplorer Lite CD.	22-SCM-232	✓	✓	✓	✓	✓
Serial Cable. 2.0 meter with a locking low profile connector. Connects the serial converter to a 9-pin sub-miniature D female computer connector.	1203-SFC	✓	✓	✓	✓	✓
Serial Null Modem Adapter. Use when connecting the serial converter to DriveExplorer on a handheld PC.	1203-SNM	✓	✓	✓	✓	✓
Universal Serial Bus™ (USB) Converter includes 2m USB, 20-HIM-H10 and 22-HIM-H10 Cables.	1203-USB	✓	✓	✓	✓	✓
DSI Cable. 2.0 meter RJ45 to RJ45 cable, male to male connectors.	22-RJ45CBL-C20	✓	✓	✓	✓	✓
Splitter Cable. RJ45 one to two port splitter cable.	AK-U0-RJ45-SC1	✓	✓	✓	✓	✓
Terminal Block. RJ45 two position terminal block (6 pieces) with two 120 Ohm terminating resistors (loose).	AK-U0-RJ45-TB2P	✓	✓	✓	✓	✓
Terminating Resistors. 120 Ohm resistor embedded in an RJ45 connector (2 pieces).	AK-U0-RJ45-TR1	✓	✓	✓	✓	✓
DSI External Communications Kit. External mounting kit for 22-COMM Communication Adapters.	22-XCOMM-DC-BASE	✓	✓	✓	✓	✓
External Communications Kit Power Supply Optional 100...240V AC Power Supply for External DSI Communications Kit.	20-XCOMM-AC-PS1	✓	✓	✓	✓	✓
Compact I/O Module (3 Channel)	1769-SM2	✓	✓	✓	✓	✓
Serial Flash Firmware Kit Updates drive firmware via computer.	AK-U9-FLSH1					✓
Communication Adapter Cover Houses the Communication Adapter for B and C Frame drives. Note: Cover adds 25 mm (0.98 in.) to the overall depth of the drive.						
Frame B Drive (PowerFlex 40)	22B-CCB			✓ ◆		
Frame C Drive (PowerFlex 40)	22B-CCC			✓ ◆		
Frame C Drive (PowerFlex 400)	22C-CCC					✓ ◆
Frame B Drive (PowerFlex 40P)	22D-CCB				✓ ◆	
Frame C Drive (PowerFlex 40P)	22D-CCC				✓ ◆	

- ‡ When a 22-COMM-P adapter is configured for multi-drive mode, a PowerFlex 40, 40P or 400 drive must be used as a master drive on the network.
- § PowerFlex 4 and PowerFlex 4M drives require External DSI Communication Kits. Communication Adapters cannot be drive mounted.
- △ Requires a Communication Adapter Cover when used with Frame B and C PowerFlex 40/40P drives or Frame C PowerFlex 400 drives.
- ◆ If IP30, NEMA/UL Type 1 is required, a 22-JBCB (Frame B drives) or 22-JBCC (Frame C drives) must also be ordered.

**IP30, NEMA/UL Type 1 Conversion Kit**

Description	Frame	Cat. No.	Used with PowerFlex Drive				
			4M	4	40	40P	400
Converts IP20 drive to IP30, NEMA/UL Type 1 enclosure. Includes conduit box, mounting screws and plastic top panel.	A	22-JBAA		✓			
	B	22-JBAB		✓	✓	✓	
	C	22-JBAC			✓	✓	✓
Converts IP20 drive to IP30, NEMA/UL Type 1 enclosure. Includes communication option conduit box, mounting screws and plastic top panel.	B	22-JBCB			✓	✓	
	C	22-JBCC			✓	✓	✓

## Dynamic Brake Resistors

Drive Rating			Minimum Resistance	Resistance <sup>♣</sup>	Cat. No. <sup>∇</sup>	Used with PowerFlex Drive				
Voltage	kW	Hp	Ohms ±10%	Ohms ±5%		4M	4	40	40P	400
100...120V, 50/60 Hz, Single-Phase	0.2	0.25	48	91	AK-R2-091P500		✓			
	0.4	0.5	48	91	AK-R2-091P500		✓	✓		
	0.75	1	48	91	AK-R2-091P500		✓	✓		
	1.1	1.5	48	91	AK-R2-091P500			✓		
200...240V, 50/60 Hz, Single-Phase	0.2	0.25	48	91	AK-R2-091P500		✓			
	0.4	0.5	48	91	AK-R2-091P500		✓	✓		
	0.75	1	48	91	AK-R2-091P500		✓	✓		
	1.5	2	48	91	AK-R2-091P500		✓	✓		
	2.2	3	32	47	AK-R2-047P500			✓		
200...240V, 50/60 Hz, Three-Phase	0.2	0.25	48	91	AK-R2-091P500		✓			
	0.4	0.5	48	91	AK-R2-091P500		✓	✓	✓	
	0.75	1	48	91	AK-R2-091P500		✓	✓	✓	
	1.5	2	48	91	AK-R2-091P500		✓	✓	✓	
	2.2	3	32	47	AK-R2-047P500		✓	✓	✓	
	3.7	5	19	47	AK-R2-047P500		✓	✓	✓	
	5.5	7.5	13	30	AK-R2-030P1K2	✓		✓	✓	
380...480V, 50/60 Hz, Three-Phase	0.4	0.5	97	360	AK-R2-360P500		✓	✓	✓	
	0.75	1	97	360	AK-R2-360P500		✓	✓	✓	
	1.5	2	97	360	AK-R2-360P500		✓	✓	✓	
	2.2	3	97	120	AK-R2-120P1K2		✓	✓	✓	
	4.0	5	77	120	AK-R2-120P1K2		✓	✓	✓	
	5.5	7.5	55	120	AK-R2-120P1K2	✓		✓	✓	
	7.5	10	39	120	AK-R2-120P1K2	✓		✓	✓	
	11	15	24	120	AK-R2-120P1K2 &	✓		✓	✓	
500...600V, 50/60 Hz, Three-Phase	0.75	1	120	360	AK-R2-360P500			✓	✓	
	1.5	2	120	360	AK-R2-360P500			✓	✓	
	2.2	3	82	120	AK-R2-120P1K2			✓	✓	
	4.0	5	82	120	AK-R2-120P1K2			✓	✓	
	5.5	7.5	51	120	AK-R2-120P1K2			✓	✓	
	7.5	10	51	120	AK-R2-120P1K2			✓	✓	
	11	15	51	120	AK-R2-120P1K2 &			✓	✓	

<sup>♣</sup> Verify resistor Ohms against minimum resistance for drive being used.

<sup>∇</sup> Resistors listed are rated 5% duty cycle.

& Requires two resistors wired in parallel.



Spare Parts

Description	Cat. No.	Used with PowerFlex Drive					
		4M	4	40	40P	400	
Fan Replacement Kits	Fan Replacement Kit - Frame A	SK-U1-FAN1-A1		✓			
	Fan Replacement Kit - Frame B, 1 Fan	SK-U1-FAN1-B1		✓	✓	✓	
	Fan Replacement Kit - Frame B, 2 Fans	SK-U1-FAN2-B1		✓	✓	✓	
	Fan Replacement Kit - Frame A	SK-U1-FFAN1-A1	✓				
	Fan Replacement Kit - Frame B	SK-U1-FFAN1-B1	✓				
	Fan Replacement Kit - Frame C	SK-U1-FFAN1-C1	✓				
	Fan Replacement Kit - Frame C, 1 Fan	SK-U1-FAN1-C1			✓	✓	✓★
	Fan Replacement Kit - Frame C, 1 Fan, 15 Hp	SK-U1-FAN1-C2			✓	✓	✓‡
	Fan Replacement Kit, NEMA 4X	SK-U1-FAN1-B4			✓		
	Fan Replacement Kit - Frame D, 2 Fans, B049 . . . B090 & D038 . . . D060 Ratings	SK-U1-FAN2-D1					✓
	Fan Replacement Kit - Frame E, 2 Fans, B120 . . . B145 & D072 . . . D142 Ratings	SK-U1-FAN2-E2					✓
	Fan Replacement Kit - Frame F, 2 Fans, IGBT, D170 & D208 Ratings	SK-U1-FAN2-F1					✓
	Fan Replacement Kit - Frame F, 1 Fan, Rectifier, D170 & D208 Ratings	SK-U1-FAN1-F2					✓
	Fan Replacement Kit - Frame F, 1 Fan, Choke, D170 & D208 Ratings	SK-U1-FAN1-F3					✓
	Fan Replacement Kit - Frame G, 1 Fan (Side), D260 & D310 Ratings	SK-U1-FAN1-G1					✓
	Fan Replacement Kit - Frame G, 4 Fans (Bottom), D260 & D310 Ratings	SK-U1-FAN4-G3					✓
	Fan Replacement Kit - Frame H, 1 Fan (Upper Side), D370 & D460 Ratings	SK-U1-FAN1-H1					✓
	Fan Replacement Kit - Frame H, 1 Fan (Middle Side), D370 & D460 Ratings	SK-U1-FAN1-H2					✓
	Fan Replacement Kit - Frame H, 4 Fans (Bottom), D370 & D460 Ratings	SK-U1-FAN4-H3					✓
	Covers	Encoder Terminal Cover (All Frames)	SK-U1-DCVR4-EN				✓
Frame A Cover with Power Terminal Guard		SK-U1-ACVR1-A1		✓			
Frame B Cover with Power Terminal Guard		SK-U1-ACVR1-B1		✓			
Frame A Cover		SK-U1-FCVR-A1	✓				
Frame B Cover		SK-U1-FCVR-B1	✓				
Frame C Cover		SK-U1-FCVR-C1	✓				
Frame B Cover with Power Terminal Guard		SK-U1-BCVR1-B1			✓		
Frame C Cover with Power Terminal Guard		SK-U1-BCVR1-C1			✓		
Frame B Cover, NEMA 4X		SK-U1-BCVR1-B4			✓		
Frame B Cover with Power Terminal Guard		SK-U1-DCVR3-B1				✓	
Frame C Cover with Power Terminal Guard		SK-U1-DCVR3-C1				✓	
Frame C Cover with Power Terminal Guard		SK-U1-CCVR1-C1					✓
Frame D Cover		SK-U1-CCVR1-D1					✓
Frame E Cover		SK-U1-CCVR1-E1					✓
Frame F Cover		SK-U1-CCVR1-F1					✓
Frame G Cover		SK-U1-CCVR1-G1					✓
Frame H Cover		SK-U1-CCVR1-H1					✓
NEMA 4X Replacement Conduit Plugs		SK-U1-PLUGS-B4			✓		

★ 3 . . . 10 Hp at 200 . . . 240V AC and 3 . . . 10 Hp at 380 . . . 480V AC.

‡ 15 . . . 20 Hp at 380 . . . 480V AC.

## EMC Filters (Required to Meet CE Certification)

Drive Ratings			PowerFlex 4M		PowerFlex 4		PowerFlex 40/40P		PowerFlex 400
Input Voltage	kW	Hp	S Type Filter	L Type Filter	S Type Filter	L Type Filter	S Type Filter	L Type Filter	IPOO (NEMA/UL Type Open)
			Cat. No. ★	Cat. No. §	Cat. No. ★	Cat. No. §	Cat. No. ★	Cat. No. §	Cat. No. ★
100...120V, 50/60 Hz, Single-Phase	0.2	0.25	–	22F-RF010-AL	–	22-RF010-AL	–	–	–
	0.4	0.5	–	22F-RF010-AL	–	22-RF010-AL	–	22-RF018-BL Δ	–
	0.75	1	–	22F-RF025-BL	–	22-RF018-BL	–	22-RF018-BL Δ	–
	1.1	1.5	–	22F-RF025-BL	–	22-RF025-CL ♣	–	22-RF018-BL Δ	–
200...240V, 50/60 Hz, Single-Phase	0.2	0.25	‡	22F-RF010-AL	‡	22-RF010-AL	–	–	–
	0.4	0.5	‡	22F-RF010-AL	‡	22-RF010-AL	‡	22-RF018-BL Δ	–
	0.75	1	‡	22F-RF010-AL	‡	22-RF010-AL	‡	22-RF018-BL Δ	–
	1.5	2	‡	22F-RF025-BL	‡	22-RF018-BL	‡	22-RF018-BL Δ	–
200...240V, 50/60 Hz, Single-Phase, NO BRAKE	0.2	0.25	–	–	‡	22-RF010-AL	–	–	–
	0.4	0.5	–	–	‡	22-RF010-AL	–	–	–
	0.75	1	–	–	‡	22-RF010-AL	–	–	–
	1.5	2	–	–	‡	22-RF018-BL	–	–	–
200...240V, 50/60 Hz, Three-Phase	0.2	0.25	22F-RF9P5-AS	22F-RF9P5-AL	22-RF9P5-AS	22-RF9P5-AL	–	–	–
	0.4	0.5	22F-RF9P5-AS	22F-RF9P5-AL	22-RF9P5-AS	22-RF9P5-AL	22-RF021-BS ♦	22-RF021-BL	–
	0.75	1	22F-RF9P5-AS	22F-RF9P5-AL	22-RF9P5-AS	22-RF9P5-AL	22-RF021-BS ♦	22-RF021-BL	–
	1.5	2	22F-RF9P5-AS	22F-RF9P5-AL	22-RF9P5-AS	22-RF9P5-AL	22-RF021-BS ♦	22-RF021-BL	–
	2.2	3	22F-RF021-BS	22F-RF021-BL	22-RF021-BS	22-RF021-BL	22-RF021-BS ♦	22-RF021-BL	22-RF034-CS
	3.7	5	22F-RF021-BS	22F-RF021-BL	22-RF021-BS	22-RF021-BL	22-RF021-BS ♦	22-RF021-BL	22-RF034-CS
	5.5	7.5	22F-RF039-CS	22F-RF039-CL	–	–	22-RF034-CS	22-RF034-CL	22-RF034-CS
	7.5	10	22F-RF039-CS	22F-RF039-CL	–	–	22-RF034-CS	22-RF034-CL	22-RF034-CS
	11	15	–	–	–	–	–	–	22-RFD070
	15	20	–	–	–	–	–	–	22-RFD100
	18.5	25	–	–	–	–	–	–	22-RFD100
	22	30	–	–	–	–	–	–	22-RFD150
	30	40	–	–	–	–	–	–	22-RFD150
	37	50	–	–	–	–	–	–	22-RFD180
380...480V, 50/60 Hz, Three-Phase	0.4	0.5	22F-RF6P0-AS	22F-RF6P0-AL	22-RF5P7-AS	22-RF5P7-AL	22-RF012-BS	22-RF012-BL	–
	0.75	1	22F-RF6P0-AS	22F-RF6P0-AL	22-RF5P7-AS	22-RF5P7-AL	22-RF012-BS	22-RF012-BL	–
	1.5	2	22F-RF6P0-AS	22F-RF6P0-AL	22-RF5P7-AS	22-RF5P7-AL	22-RF012-BS	22-RF012-BL	–
	2.2	3	22F-RF012-BS	22F-RF012-BL	22-RF012-BS	22-RF012-BL	22-RF012-BS	22-RF012-BL	22-RF018-CS
	3.7	5	22F-RF012-BS	22F-RF012-BL	22-RF012-BS	22-RF012-BL	22-RF012-BS	22-RF012-BL	22-RF018-CS
	5.5	7.5	22F-RF026-CS	22F-RF026-CL	–	–	22-RF018-CS	22-RF018-CL	22-RF018-CS
	7.5	10	22F-RF026-CS	22F-RF026-CL	–	–	22-RF018-CS	22-RF018-CL	22-RF018-CS
	11	15	22F-RF026-CS	22F-RF026-CL	–	–	22-RF026-CS	22-RF026-CL	22-RF026-CS
	15	20	–	–	–	–	–	–	22-RFD036
	18.5	25	–	–	–	–	–	–	22-RFD050
	22	30	–	–	–	–	–	–	22-RFD050
	30	40	–	–	–	–	–	–	22-RFD070
	37	50	–	–	–	–	–	–	22-RFD100
	45	60	–	–	–	–	–	–	22-RFD100
	55	75	–	–	–	–	–	–	22-RFD150
	75	100	–	–	–	–	–	–	22-RFD180
	90	125	–	–	–	–	–	–	22-RFD208
110	150	–	–	–	–	–	–	22-RFD208	
132	200	–	–	–	–	–	–	22-RFD323	
160	250	–	–	–	–	–	–	22-RFD480	
200	300	–	–	–	–	–	–	22-RFD480	
250	350	–	–	–	–	–	–	22-RFD480	

EMC Filters (continued)

Drive Ratings			PowerFlex 4M		PowerFlex 4		PowerFlex 40/40P		PowerFlex 400
Input Voltage	kW	Hp	S Type Filter	L Type Filter	S Type Filter	L Type Filter	S Type Filter	L Type Filter	IPOO (NEMA/UL Type Open)
			Cat. No. ★	Cat. No. §	Cat. No. ★	Cat. No. §	Cat. No. ★	Cat. No. §	Cat. No. ★
500...600V, 50/60 Hz, Three-Phase	0.75	1	–	–	–	–	–	22-RF8P0-BL	–
	1.5	2	–	–	–	–	–	22-RF8P0-BL	–
	2.2	3	–	–	–	–	–	22-RF8P0-BL	–
	4.0	5	–	–	–	–	–	22-RF8P0-BL	–
	5.5	7.5	–	–	–	–	–	22-RF015-CL	–
	7.5	10	–	–	–	–	–	22-RF015-CL	–
	11	15	–	–	–	–	–	22-RF024-CL	–

- ★ This filter is suitable for use with a cable length of up to 10 meters for Class A and 1 meter for Class B environments.
- ‡ Drives are available in these ratings with internal "S Type" filters.
- § This filter is suitable for use with a cable length of up to 100 meters for Class A and 5 meters for Class B environments.
- ♣ The piggyback mounting option cannot be used with Frame B PowerFlex 4 drives and Frame C EMC Line Filters.
- △ PowerFlex 40 Only.
- ◆ Filter must be Series B or later.

DC Series Bus Inductors

Voltage	Drive Rating			Inductance mH	Cat. No.	Used with PowerFlex Drive				
	kW	Hp	Amps			4M	4	40	40P	400
200...240V, 50/60 Hz, Three-Phase	2.2	3	12	1.00	1321-DC12-1					✓
	3.7	5	17.5	0.65	1321-DC18-1					✓
	5.5	7.5	32	0.85	1321-DC32-1			✓		✓
	7.5	10	40	0.75	1321-DC40-2			✓		✓
400...480V, 50/60 Hz, Three-Phase	2.2	3	6	2	1321-DC9-2					✓
	4.0	5	10.5	2.1	1321-DC12-2					✓
	5.5	7.5	18	3.75	1321-DC18-4			✓		✓
	7.5	10	25	1.28	1321-DC25-4			✓		✓
	11	15	32	2.68	1321-DC32-3			✓		✓
	15	20	30	2.5	1321-DC40-4					✓
500...600V, 50/60 Hz, Three-Phase	5.5	7.5	12	2.1	1321-DC12-2_600			✓		
	7.5	10	18	3.75	1321-DC18-4			✓		
	11	15	25	1.28	1321-DC25-4			✓		

Isolation Transformers for PowerFlex 400 - IP32, NEMA/UL Type 3R Standalone, 4...6% Nominal Impedance

Rating kW   Hp		Wiring Diagram (see page 126)	208V Primary	230V Primary	460V Primary		575V Primary	
			208V, 60 Hz, Three-Phase Secondary	230V, 60 Hz, Three-Phase Secondary	230V, 60 Hz, Three-Phase Secondary	460V, 60 Hz, Three-Phase Secondary	230V, 60 Hz, Three-Phase Secondary	460V, 60 Hz, Three-Phase Secondary
			Cat. No.	Cat. No.	Cat. No.	Cat. No.	Cat. No.	Cat. No.
2.2	3.0	1	1321-3TW005-XX	1321-3TW005-AA	1321-3TW005-BA	1321-3TW005-BB	1321-3TW005-CA	1321-3TW005-CB
22	30	2	–	1321-3TW040-AA	1321-3TW040-BA	1321-3TW040-BB	1321-3TW040-CA	1321-3TW040-CB
30	40	2	–	1321-3TW051-AA	1321-3TW051-BA	1321-3TW051-BB	1321-3TW051-CA	1321-3TW051-CB
37	50	2	–	1321-3TH063-AA	1321-3TH063-BA	1321-3TH063-BB	–	–
45	60	2	–	–	–	1321-3TH075-BB	–	–
55	75	2	–	–	–	1321-3TH093-BB	–	–
75	100	2	–	–	–	1321-3TH118-BB	–	–
90	125	2	–	–	–	1321-3TH145-BB	–	–
110	150	2	–	–	–	1321-3TH175-BB	–	–
132	200	2	–	–	–	1321-3TH220-BB	–	–
160	250	2	–	–	–	1321-3TH275-BB	–	–
200	300	2	–	–	–	1321-3TH330-BB	–	–
250	350	2	–	–	–	1321-3TH440-BB	–	–

## Line Reactors - 3% Impedance

Voltage	Drive Ratings			IP00 ★ (NEMA/UL Open Type)	IP11 ★ (NEMA/UL Type 1)	Used with PowerFlex Drive				
	kW	Hp	Amps	Cat. No.	Cat. No.	4M	4	40	40P	400
200...240V, 60 Hz, Three-Phase	0.2	0.25	2.0	1321-3R2-A	--	✓	✓			
	0.4	0.5	4.0	1321-3R4-B	--	✓	✓	✓	✓	
	0.75	1	8.0	1321-3R8-B	--	✓	✓	✓	✓	
	1.5	2	8.0	1321-3R8-A	--	✓	✓	✓	✓	
	2.2	3	12	1321-3R12-A	1321-3RA12-A	✓	✓	✓	✓	✓
	3.7	5	17.5	1321-3R18-A	1321-3RA18-A	✓	✓	✓	✓	✓
	5.5	7.5	24	1321-3R25-A	1321-3RA25-A	✓		✓	✓	✓
	7.5	10	33	1321-3R35-A	1321-3RA35-A	✓		✓	✓	✓
	11	15	49	1321-3R45-A	1321-3RA45-A					✓
	15	20	65	1321-3R55-A	1321-3RA55-A					✓
	18.5	25	75	1321-3R80-A	1321-3RA80-A					✓
	22	30	90	1321-3R80-A	1321-3RA80-A					✓
	30	40	120	1321-3R100-A	1321-3RA100-A					✓
37	50	145	1321-3R130-A	1321-3RA130-A					✓	
380...480V, 60 Hz, Three-Phase	0.4	0.5	2.0	1321-3R2-B	--	✓	✓	✓	✓	
	0.75	1	4.0	1321-3R4-C	--	✓	✓	✓	✓	
	1.5	2	4.0	1321-3R4-B	--	✓	✓	✓	✓	
	2.2	3	6.0	1321-3R8-C	1321-3RA8-C	✓	✓	✓	✓	✓
	4.0	5	10.5	1321-3R8-B	1321-3RA8-B	✓	✓	✓	✓	✓
	5.5	7.5	12	1321-3R12-B	1321-3RA12-B	✓		✓	✓	✓
	7.5	10	17	1321-3R18-B	1321-3RA18-B	✓		✓	✓	✓
	11	15	22	1321-3R25-B	1321-3RA25-B	✓		✓	✓	✓
	15	20	30	1321-3R35-B	1321-3RA35-B					✓
	18.5	25	38	1321-3R35-B	1321-3RA35-B					✓
	22	30	45.5	1321-3R45-B	1321-3RA45-B					✓
	30	40	60	1321-3R55-B	1321-3RA55-B					✓
	37	50	72	1321-3R80-B	1321-3RA80-B					✓
	45	60	88	1321-3R80-B	1321-3RA80-B					✓
	55	75	105	1321-3R100-B	1321-3RA100-B					✓
	75	100	142	1321-3R130-B	1321-3RA130-B					✓
90	125	170	1321-3R160-B	1321-3RA160-B					✓	
110	150	208	1321-3R200-B	1321-3RA200-B					✓	
500...600V, 60 Hz, Three-Phase	0.75	1	2.0	1321-3R2-B	--			✓	✓	
	1.5	2	4.0	1321-3R4-C	--			✓	✓	
	2.2	3	4.0	1321-3R4-B	--			✓	✓	
	4.0	5	8.0	1321-3R8-C	--			✓	✓	
	5.5	7.5	12	1321-3R12-B	--			✓	✓	
	7.5	10	12	1321-3R12-B	--			✓	✓	
	11	15	18	1321-3R18-B	--			✓	✓	

★ Catalog numbers listed are for 3% impedance. 5% impedance reactor types are also available. Refer to 1321 Power Conditioning Products Technical Data, publication 1321-TD001.



# PowerFlex 523 AC Drive

PowerFlex 523 AC drives are designed to help reduce installation and configuration time with an innovative modular design while providing just enough control for your application. These drives offer convenient programming features with the fast upload and download of configuration files over a standard USB connection, as well as installation flexibility with Zero Stacking and a high ambient operating temperature. PowerFlex 523 AC drives also provide a variety of motor control options, making these drives ideal for simple applications.

## PowerFlex 523 AC Drive at a glance

### Ratings

100...120V:	0.2...1.1 kW / 0.25...1.5 Hp / 1.6...6 A
200...240V:	0.2...15 kW / 0.25...20 Hp / 1.6...62.1 A
380...480V:	0.4...22 kW / 0.5...30 Hp / 1.4...43 A
525...600V:	0.4...22 kW / 0.5...30 Hp / 0.9...32 A

### Motor Control

- V/Hz Control
- Sensorless Vector Control

### Enclosures

- IP20, NEMA/UL Type Open
- IP30, NEMA/UL Type 1 (with optional kit)

### Additional Features

- Modular design eases installation
- Operating temperatures from -20 °C (-4 °F) up to 50 °C (122 °F). Up to 70 °C (158 °F) with current derating and optional control module fan kit
- LCD HIM with multi-language support
- MainsFree™ Programming via USB
- Configure using Connected Components Workbench Software
- Add-on Profiles for Studio 5000™ Logix Designer Software
- Automatic Device Configuration ★
- Economizer motor control for energy savings
- Application specific parameter groups
- Option for dual port EtherNet/IP adapter which supports DLR functionality. DeviceNet and PROFIBUS DP adapters also available.
- Conformal coating to IEC 60721 3C2 standards

### Certifications

- ACS 156
- C-Tick
- c-UL, UL
- CE
- GOST-R
- KCC
- REACH
- RoHS
- SEMI F47

### Options

See pages 52...56

★ Requires Dual-port EtherNet/IP Option Module (Cat. No. 25-COMM-E2P).

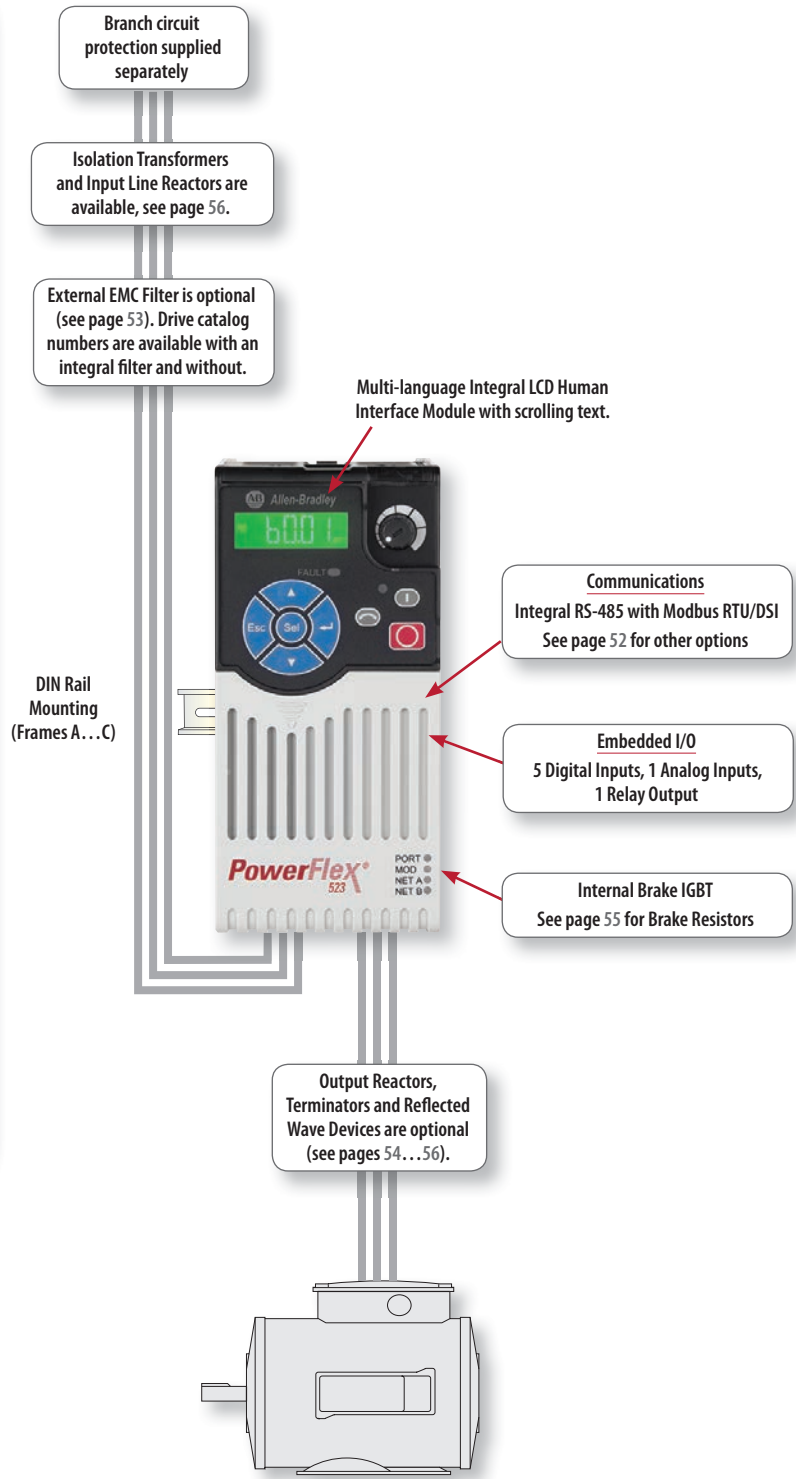

## Additional Information

PowerFlex 520-Series Technical Data, publication 520-TD001

PowerFlex 520-Series User Manual, publication 520-UM001

## Catalog Number Explanation

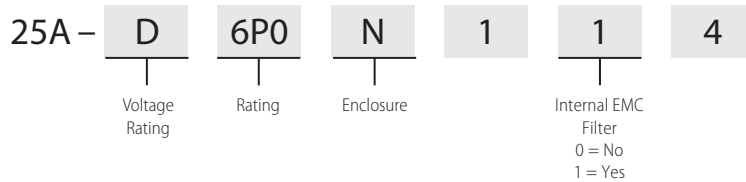

## Product Selection

### 100...120V AC, Single-Phase, 50/60 Hz

Drive Ratings					Frame Size	No Filter	with Integral EMC Filter
Normal Duty		Heavy Duty		Output Current		Cat. No.	Cat. No.
kW	Hp	kW	Hp	A			
0.2	0.25	0.2	0.25	1.6	A	25A-V1P6N104	–
0.4	0.5	0.4	0.5	2.5	A	25A-V2P5N104	–
0.75	1	0.75	1	4.8	B	25A-V4P8N104	–
1.1	1.5	1.1	1.5	6	B	25A-V6P0N104	–

### 200...240V AC, Single-Phase, 50/60 Hz

Drive Ratings					Frame Size	No Filter	with Integral EMC Filter ‡
Normal Duty		Heavy Duty		Output Current		Cat. No.	Cat. No.
kW	Hp	kW	Hp	A			
0.2	0.25	0.2	0.25	1.6	A	25A-A1P6N104	25A-A1P6N114
0.4	0.5	0.4	0.5	2.5	A	25A-A2P5N104	25A-A2P5N114
0.75	1	0.75	1	4.8	A	25A-A4P8N104	25A-A4P8N114
1.5	2	1.5	2	8	B	25A-A8P0N104	25A-A8P0N114
2.2	3	2.2	3	11	B	25A-A011N104	25A-A011N114

‡ This filter is suitable for use with cable lengths up to 10 meters (32.8 feet) for C2 spec and 20 meters (65.6 feet) for C3 spec.

### 200...240V AC, Three-Phase, 50/60 Hz

Drive Ratings					Frame Size	No Filter	with Integral EMC Filter
Normal Duty		Heavy Duty		Output Current		Cat. No.	Cat. No.
kW	Hp	kW	Hp	A			
0.2	0.25	0.2	0.25	1.6	A	25A-B1P6N104	–
0.4	0.5	0.4	0.5	2.5	A	25A-B2P5N104	–
0.75	1	0.75	1	5	A	25A-B5P0N104	–
1.5	2	1.5	2	8	A	25A-B8P0N104	–
2.2	3	2.2	3	11	A	25A-B011N104	–
4	5	4	5	17.5	B	25A-B017N104	–
5.5	7.5	5.5	7.5	24	C	25A-B024N104	–
7.5	10	7.5	10	32.2	D	25A-B032N104	–
11	15	11	15	48.3	E	25A-B048N104 ♣	–
15	20	11	15	62.1	E	25A-B062N104 ♣	–

♣ Contact your local Rockwell Automation sales office or Allen-Bradley distributor for availability.

### 380...480V AC, Three-Phase, 50/60 Hz

Drive Ratings					Frame Size	No Filter	with Integral EMC Filter ‡
Normal Duty		Heavy Duty		Output Current		Cat. No.	Cat. No.
kW	Hp	kW	Hp	A			
0.4	0.5	0.4	0.5	1.4	A	25A-D1P4N104	25A-D1P4N114
0.75	1	0.75	1	2.3	A	25A-D2P3N104	25A-D2P3N114
1.5	2	1.5	2	4	A	25A-D4P0N104	25A-D4P0N114
2.2	3	2.2	3	6	A	25A-D6P0N104	25A-D6P0N114
4	5	4	5	10.5	B	25A-D010N104	25A-D010N114
5.5	7.5	5.5	7.5	13	C	25A-D013N104	25A-D013N114
7.5	10	7.5	10	17	C	25A-D017N104	25A-D017N114
11	15	11	15	24	D	25A-D024N104	25A-D024N114
15	20	11	15	30	D	25A-D030N104 ♣	25A-D030N114 ♣
18.5	25	15	20	37	E	25A-D037N114 § ♣	25A-D037N114 ♣
22	30	18.5	25	43	E	25A-D043N114 § ♣	25A-D043N114 ♣

‡ This filter is suitable for use with cable lengths up to 10 meters (32.8 feet) for C2 spec and 20 meters (65.6 feet) for C3 spec.

§ With EMC filter.

♣ Contact your local Rockwell Automation sales office or Allen-Bradley distributor for availability.

### 525...600V AC, Three-Phase, 50/60 Hz

Drive Ratings					Frame Size	No Filter	with Integral EMC Filter
Normal Duty		Heavy Duty		Output Current		Cat. No.	Cat. No.
kW	Hp	kW	Hp	A			
0.4	0.5	0.4	0.5	0.9	A	25A-E0P9N104	–
0.75	1	0.75	1	1.7	A	25A-E1P7N104	–
1.5	2	1.5	2	3	A	25A-E3P0N104	–
2.2	3	2.2	3	4.2	A	25A-E4P2N104	–
4	5	4	5	6.6	B	25A-E6P6N104	–
5.5	7.5	5.5	7.5	9.9	C	25A-E9P9N104	–
7.5	10	7.5	10	12	C	25A-E012N104	–
11	15	11	15	19	D	25A-E019N104	–
15	20	11	15	22	D	25A-E022N104 ♣	–
18.5	25	15	20	27	E	25A-E027N104 ♣	–
22	30	18.5	25	32	E	25A-E032N104 ♣	–

♣ Contact your local Rockwell Automation sales office or Allen-Bradley distributor for availability.

## Approximate Dimensions and Weights

Dimensions are in mm (in.) - weights are in kg (lb)

### IP20, NEMA/UL Type Open

Frame	H	W	D	Weight
A	152.0 (5.98)	72.0 (2.83)	172.0 (6.77)	1.10 (2.4)
B	180.0 (7.08)	87.0 (3.42)	172.0 (6.77)	1.60 (3.5)
C	220.0 (8.66)	109.0 (4.29)	184.0 (7.24)	2.30 (5.1)
D	260.0 (10.23)	130.0 (5.11)	212.0 (8.34)	3.20 (7.1)
E	300.0 (11.81)	185.0 (7.28)	279.0 (10.98)	12.90 (28.4)

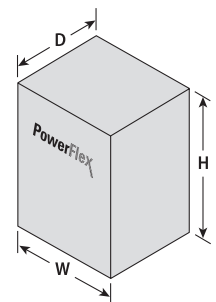

# PowerFlex 525 AC Drive

PowerFlex 525 AC drives feature an innovative, modular design offering fast and easy installation and configuration. These cost-effective compact drives come with embedded EtherNet/IP™ communications, safety, USB configuration and a high ambient operating temperature capability. PowerFlex 525 AC drives also provide a variety of motor control algorithms including volts per hertz, sensorless vector control and closed loop velocity vector control, making these drives ideal for a vast array of applications.

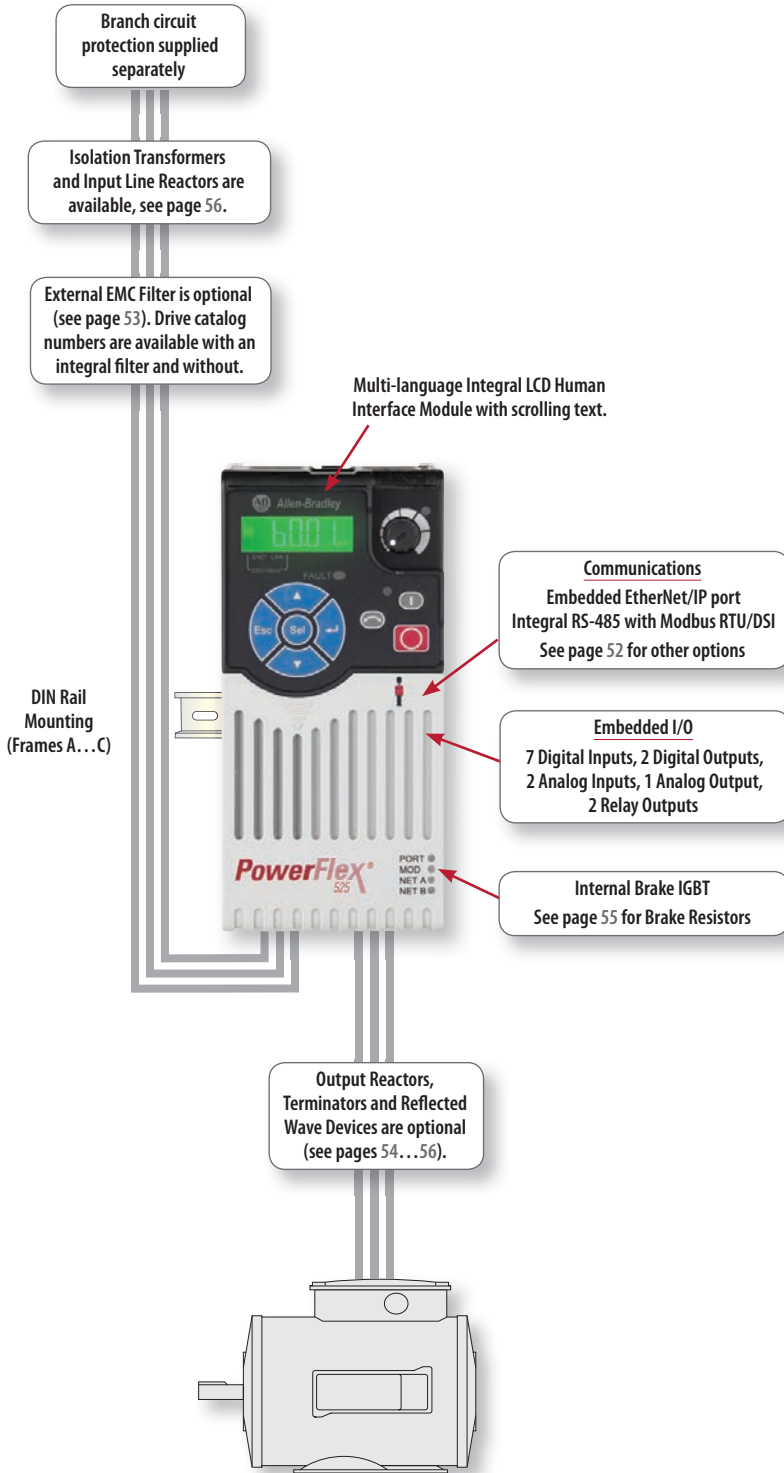

## PowerFlex 525 AC Drive at a glance

### Ratings

100...120V:	0.4...1.1 kW / 0.5...1.5 Hp / 2.5...6 A
200...240V:	0.4...15 kW / 0.5...20 Hp / 2.5...62.1 A
380...480V:	0.4...22 kW / 0.5...30 Hp / 2.5...62.1 A
525...600V:	0.4...22 kW / 0.5...30 Hp / 0.9...32 A

### Motor Control

- V/Hz Control
- Sensorless Vector Control
- Closed Loop Velocity Vector Control
- Permanent Magnet Motor Control \*

### Enclosures

- IP20, NEMA/UL Type Open
- IP30, NEMA/UL Type 1 (with optional kit)

### Safety

Safe Torque-Off PLd/SIL2 Cat 3 (meets ISO 13849-1)

### Additional Features

- Modular design eases installation
- Operating temperatures from -20 °C (-4 °F) up to 50 °C (122 °F). Up to 70 °C (158 °F) with current derating and optional control module fan kit.
- Embedded EtherNet/IP port
- Option for dual port EtherNet/IP adapter which supports DLR functionality. DeviceNet and PROFIBUS DP adapters also available.
- Embedded Safe Torque-Off PLd/SIL2 Cat 3
- LCD HIM with multi-language support
- MainsFree™ Programming via USB
- Configure using Connected Components Workbench Software
- Add-on Profiles for Studio 5000™ Logix Designer Software
- Automatic Device Configuration
- Economizer motor control for energy savings
- Application specific parameter groups
- Simple positioning control with optional encoder card
- Conformal coating to IEC 60721 3C2 standards

### Certifications

- ACS 156
- ATEX
- C-Tick
- c-UL, UL
- CE
- EPRI/SEMI F47
- GOST-R
- KCC
- Lloyd's Register
- RoHS
- TÜV FS ISO/EN13849-1 (EN954-1)

### Options

See pages 52...56

\* Permanent magnet motor control is scheduled for a future firmware release.



## Additional Information

PowerFlex 520-Series Technical Data, publication 520-TD001  
 PowerFlex 520-Series User Manual, publication 520-UM001

## Catalog Number Explanation

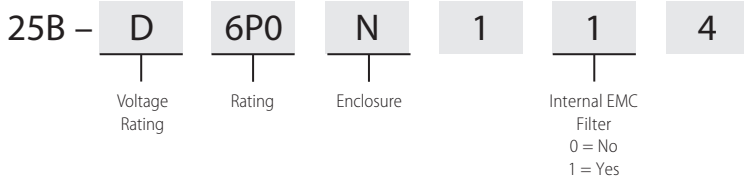

## Product Selection

### 100...120V AC, Single-Phase, 50/60 Hz

Drive Ratings						No Filter	with Integral EMC Filter
Normal Duty		Heavy Duty		Output Current	Frame Size	Cat. No.	Cat. No.
kW	Hp	kW	Hp	A			
0.4	0.5	0.4	0.5	2.5	A	25B-V2P5N104	—
0.75	1	0.75	1	4.8	B	25B-V4P8N104	—
1.1	1.5	1.1	1.5	6	B	25B-V6P0N104	—

### 200...240V AC, Single-Phase, 50/60 Hz

Drive Ratings						No Filter	with Integral EMC Filter ‡
Normal Duty		Heavy Duty		Output Current	Frame Size	Cat. No.	Cat. No.
kW	Hp	kW	Hp	A			
0.4	0.5	0.4	0.5	2.5	A	25B-A2P5N104	25B-A2P5N114
0.75	1	0.75	1	4.8	A	25B-A4P8N104	25B-A4P8N114
1.5	2	1.5	2	8	B	25B-A8P0N104	25B-A8P0N114
2.2	3	2.2	3	11	B	25B-A011N104	25B-A011N114

‡ This filter is suitable for use with cable lengths up to 10 meters (32.8 feet) for C2 spec and 20 meters (65.6 feet) for C3 spec.

### 200...240V AC, Three-Phase, 50/60 Hz

Drive Ratings						No Filter	with Integral EMC Filter
Normal Duty		Heavy Duty		Output Current	Frame Size	Cat. No.	Cat. No.
kW	Hp	kW	Hp	A			
0.4	0.5	0.4	0.5	2.5	A	25B-B2P5N104	—
0.75	1	0.75	1	5	A	25B-B5P0N104	—
1.5	2	1.5	2	8	A	25B-B8P0N104	—
2.2	3	2.2	3	11	A	25B-B011N104	—
4	5	4	5	17.5	B	25B-B017N104	—
5.5	7.5	5.5	7.5	24	C	25B-B024N104	—
7.5	10	7.5	10	32.2	D	25B-B032N104	—
11	15	11	15	48.3	E	25B-B048N104	—
15	20	11	15	62.1	E	25B-B062N104	—

## 380...480V AC, Three-Phase, 50/60 Hz

Drive Ratings					Frame Size	No Filter	with Integral EMC Filter ‡
Normal Duty		Heavy Duty		Output Current		Cat. No.	Cat. No.
kW	Hp	kW	Hp	A			
0.4	0.5	0.4	0.5	1.4	A	25B-D1P4N104	25B-D1P4N114
0.75	1	0.75	1	2.3	A	25B-D2P3N104	25B-D2P3N114
1.5	2	1.5	2	4	A	25B-D4P0N104	25B-D4P0N114
2.2	3	2.2	3	6	A	25B-D6P0N104	25B-D6P0N114
4	5	4	5	10.5	B	25B-D010N104	25B-D010N114
5.5	7.5	5.5	7.5	13	C	25B-D013N104	25B-D013N114
7.5	10	7.5	10	17	C	25B-D017N104	25B-D017N114
11	15	11	15	24	D	25B-D024N104	25B-D024N114
15	20	11	15	30	D	25B-D030N104	25B-D030N114
18.5	25	15	20	37	E	25B-D037N114 §	25B-D037N114
22	30	18.5	25	43	E	25B-D043N114 §	25B-D043N114

‡ This filter is suitable for use with cable lengths up to 10 meters (32.8 feet) for C2 spec and 20 meters (65.6 feet) for C3 spec.

§ With EMC filter.

## 525...600V AC, Three-Phase, 50/60 Hz

Drive Ratings					Frame Size	No Filter	with Integral EMC Filter
Normal Duty		Heavy Duty		Output Current		Cat. No.	Cat. No.
kW	Hp	kW	Hp	A			
0.4	0.5	0.4	0.5	0.9	A	25B-E0P9N104	—
0.75	1	0.75	1	1.7	A	25B-E1P7N104	—
1.5	2	1.5	2	3	A	25B-E3P0N104	—
2.2	3	2.2	3	4.2	A	25B-E4P2N104	—
4	5	4	5	6.6	B	25B-E6P6N104	—
5.5	7.5	5.5	7.5	9.9	C	25B-E9P9N104	—
7.5	10	7.5	10	12	C	25B-E012N104	—
11	15	11	15	19	D	25B-E019N104	—
15	20	11	15	22	D	25B-E022N104	—
18.5	25	15	20	27	E	25B-E027N104	—
22	30	18.5	25	32	E	25B-E032N104	—

## Approximate Dimensions and Weights

Dimensions are in mm (in.) - weights are in kg (lb)

## IP20, NEMA/UL Type Open

Frame	H	W	D	Weight
A	152.0 (5.98)	72.0 (2.83)	172.0 (6.77)	1.10 (2.4)
B	180.0 (7.08)	87.0 (3.42)	172.0 (6.77)	1.60 (3.5)
C	220.0 (8.66)	109.0 (4.29)	184.0 (7.24)	2.30 (5.1)
D	260.0 (10.23)	130.0 (5.11)	212.0 (8.34)	3.20 (7.1)
E	300.0 (11.81)	185.0 (7.28)	279.0 (10.98)	12.90 (28.4)

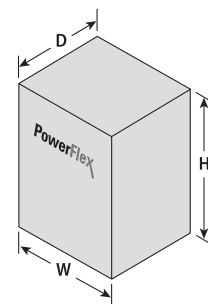

# PowerFlex 520-Series Options

## Human Interface Modules and Accessories

Description	Cat. No.
Remote (Panel Mount) LCD Display, Digital Speed Control, CopyCat Capable. Includes 2.0 meter cable. IP66, NEMA Type 4X/12 - Indoor Use Only.	22-HIM-C2S <sup>♣</sup>
Remote Handheld, LCD Display, Full Numeric Keypad, Digital Speed Control, CopyCat Capable. Includes 1.0 meter cable. IP30, NEMA Type 1. Panel mount with optional Bezel Kit.	22-HIM-A3
Bezel Kit. Panel Mount for LCD Display, Remote Handheld Unit. IP30, NEMA Type 1. Includes a 22-RJ45CBL-C20 cable.	22-HIM-B1
DSI HIM Cable (DSI HIM to RJ45 cable)	
1.0 Meter (3.3 Feet)	22-HIM-H10
2.9 Meter (9.5 Feet)	22-HIM-H30

<sup>♣</sup> The 22-HIM-C2S is smaller than the 22-HIM-C2 and cannot be used as a direct replacement.

## Communication Option Kits

Description	Cat. No.
DeviceNet™ Communication Adapter	25-COMM-D
EtherNet/IP™ Communication Adapter - Dual Port	25-COMM-E2P
PROFIBUS™ DP Communication Adapter	25-COMM-P
Serial Converter Module (RS485 to RS232). Provides serial communication via DF1 protocol for use with DriveExplorer and DriveExecutive™ software. Includes DSI to RS232 serial converter, 1203-SFC serial cable, 22-RJ45CBL-C20 cable, and DriveExplorer Lite CD.	22-SCM-232
Serial Cable. 2.0 meter with a locking low profile connector. Connects the serial converter to a 9-pin sub-miniature D female computer connector.	1203-SFC
Serial Null Modem Adapter. Use when connecting the serial converter to DriveExplorer on a handheld PC.	1203-SNM
Universal Serial Bus™ (USB) Converter includes 2m USB, 20-HIM-H10 and 22-HIM-H10 Cables.	1203-USB
DSI Cable. 2.0 meter RJ45 to RJ45 cable, male to male connectors.	22-RJ45CBL-C20
Splitter Cable. RJ45 one to two port splitter cable.	AK-U0-RJ45-SC1
Terminal Block. RJ45 two position terminal block (6 pieces) with two 120 Ohm terminating resistors (loose).	AK-U0-RJ45-TB2P
Terminating Resistors. 120 Ohm resistor embedded in an RJ45 connector (2 pieces).	AK-U0-RJ45-TR1
DSI External Communications Kit. External mounting kit for 22-COMM Communication Adapters.	22-XCOMM-DC-BASE
External Communications Kit Power Supply Optional 100...240V AC Power Supply for External DSI Communications Kit.	20-XCOMM-AC-PS1
Compact I/O Module (3 Channel)	1769-SM2

## IP30, NEMA/UL Type 1 Conversion Kit

Description	Frame	Cat. No.
Converts IP20 drive to IP30, NEMA/UL Type 1 enclosure	A	25-JBAA
	B	25-JBAB
	C	25-JBAC
	D	25-JBAD
	E	25-JBAE

## Other Options

Description	Frame	Cat. No.
EMC Grounding Plate	A	25-EMC1-FA
	B	25-EMC1-FB
	C	25-EMC1-FC
	D	25-EMC1-FD
	E	25-EMC1-FE
Mounting Adapter Plate, Bulletin 160 AC Drive to PowerFlex 525	A	25-MAP-FA
	B	25-MAP-FB
Incremental Encoder for PowerFlex 525	All	25-ENC-1
Control Module Fan Kit for 70 °C operation and/or horizontal drive mounting.	A...D	25-FAN1-70C
	E	25-FAN2-70C

**EMC Filters (Required to Meet CE Certification)**

Drive Ratings				Cat. No.	
Input Voltage	kW	Hp	Frame		
100 . . . 120V, Single-Phase, 50/60 Hz	0.2	0.25	A	25-RF011-AL	
	0.4	0.5	A		
	0.75	1	B	25-RF023-BL	
	1	1.5	B		
200 . . . 240V, Single-Phase, 50/60 Hz	0.2	0.25	A	25-RF011-AL	
	0.4	0.5	A		
	0.75	1	A		
	1.5	2	B	25-RF023-BL	
	2.2	3	B		
200 . . . 240V, Three-Phase 50/60 Hz,	0.2	0.25	A	25-RF014-AL	
	0.4	0.5	A		
	0.75	1	A		
	1.5	2	A		
	2.2	3	A		
	3.7	5	B		25-RF021-BL
	5.5	7.5	C		25-RF027-CL
	7.5	10	D		25-RF035-DL
	11	15	E	25-RF056-EL	
	15	20	E		
380 . . . 480V, Three-Phase 50/60 Hz	0.4	0.5	A	25-RF7P5-AL	
	0.75	1	A		
	1.5	2	A		
	2.2	3	A		
	3.7	5	B	25-RF014-BL	
	5.5	7.5	C	25-RF018-CL	
	7.5	10	C	25-RF033-DL	
	11	15	D		
	15	20	D		
	18.5	25	E	25-RF039-EL	
	22	30	E		
525 . . . 600V, Three-Phase, 50/60 Hz	0.4	0.5	A	25-RF8P0-BL	
	0.75	1	A		
	1.5	2	A		
	2.2	3	A		
	3.7	5	B		
	5.5	7.5	C	25-RF014-CL	
	7.5	10	C		
	11	15	D	25-RF027-DL	
	15	20	D	25-RF029-EL	
	18.5	25	E		
22	30	E			

**Control Module**

Description	Frame	Cat. No.
PowerFlex 523 Control Module (includes control module front cover)	All	25A-CTM1
PowerFlex 525 Control Module (includes control module front cover)	All	25B-CTM1

**Power Modules §**

Input Voltage	Ratings				No Filter Cat No.	with Integral EMC Filter Cat No.	
	Normal Duty		Heavy Duty				
	kW	Hp	kW	Hp			
100 . . . 120V AC, Single-Phase, 50/60 Hz	0.2	0.25	0.2	0.25	25-PM1-V1P6	–	
	0.4	0.5	0.4	0.5	25-PM1-V2P5	–	
	0.75	1	0.75	1	25-PM1-V4P8	–	
	1.5	2	1.5	2	25-PM1-V6P0	–	
200 . . . 240V AC, Single-Phase, 50/60 Hz	0.2	0.25	0.2	0.25	25-PM1-A1P6	25-PM2-A1P6	
	0.4	0.5	0.4	0.5	25-PM1-A2P5	25-PM2-A2P5	
	0.75	1	0.75	1	25-PM1-A4P8	25-PM2-A4P8	
	1.5	2	1.5	2	25-PM1-A8P0	25-PM2-A8P0	
200 . . . 240V AC, Three-Phase, 50/60 Hz	2.2	3	2.2	3	25-PM1-A011	25-PM2-A011	
	0.2	0.25	0.2	0.25	25-PM1-B1P6	–	
380 . . . 480V AC, Three-Phase, 50/60 Hz	0.4	0.5	0.4	0.5	25-PM1-B2P5	–	
	0.75	1	0.75	1	25-PM1-B5P0	–	
	1.5	2	1.5	2	25-PM1-B8P0	–	
	2.2	3	2.2	3	25-PM1-B011	–	
	4	5	4	5	25-PM1-B017	–	
	5.5	7.5	5.5	7.5	25-PM1-B024	–	
	7.5	10	7.5	10	25-PM1-B032	–	
	11	15	11	15	25-PM1-B048	–	
	15	20	11	15	25-PM1-B062	–	
	525 . . . 600V AC, Three-Phase, 50/60 Hz	0.4	0.5	0.4	0.5	25-PM1-D1P4	25-PM2-D1P4
		0.75	1	0.75	1	25-PM1-D2P3	25-PM2-D2P3
1.5		2	1.5	2	25-PM1-D4P0	25-PM2-D4P0	
2.2		3	2.2	3	25-PM1-D6P0	25-PM2-D6P0	
4		5	4	5	25-PM1-D010	25-PM2-D010	
5.5		7.5	5.5	7.5	25-PM1-D013	25-PM2-D013	
7.5		10	7.5	10	25-PM1-D017	25-PM2-D017	
11		15	11	15	25-PM1-D024	25-PM2-D024	
15		20	11	15	25-PM1-D030	25-PM2-D030	
18.5		25	15	20	–	25-PM2-D037	
22		30	18.5	25	–	25-PM2-D043	
525 . . . 600V AC, Three-Phase, 50/60 Hz	0.4	0.5	0.4	0.5	25-PM1-E0P9	–	
	0.75	1	0.75	1	25-PM1-E1P7	–	
	1.5	2	1.5	2	25-PM1-E3P0	–	
	2.2	3	2.2	3	25-PM1-E4P2	–	
	4	5	4	5	25-PM1-E6P6	–	
	5.5	7.5	5.5	7.5	25-PM1-E9P9	–	
	7.5	10	7.5	10	25-PM1-E012	–	
	11	15	11	15	25-PM1-E019	–	
	15	20	11	15	25-PM1-E022	–	
	18.5	25	15	20	25-PM1-E027	–	
	22	30	18.5	25	25-PM1-E032	–	

§ Includes power module front cover (Frames B . . . E only).

**Accessories**

Description	Frame	Cat. No.
Power Module Front Cover	B	25-PMFC-FB
	C	25-PMFC-FC
	D	25-PMFC-FD
	E	25-PMFC-FE
PowerFlex 523 Control Module Front Cover	All	25A-CTMFC1
PowerFlex 525 Control Module Front Cover	All	25B-CTMFC1
Heatsink Fan Replacement Kit	A	25-FAN1-FA
	B	25-FAN1-FB
	C	25-FAN1-FC
	D	25-FAN1-FD
	E	25-FAN1-FE
Power Terminal Guard	A	25-PTG1-FA
	B	25-PTG1-FB
	C	25-PTG1-FC
	D	25-PTG1-FD
	E	25-PTG1-FE

**Terminators**

Description ★	Cat. No.
for use with 3.7 kW (5 Hp) and below drives	1204-TFA1
for use with 1.5 kW (2 Hp) and up drives	1204-TFB2

★ For selection information, refer to Appendix A of the Wiring and Grounding Guidelines for Pulse Width Modulated (PWM) AC Drives, publication Drives-IN001.

**Reflected Wave Reduction Modules**

Voltage	kW	Hp	Cat. No.
380... 480V AC	2.2...4	3...5	1321-RWR8-DP
	4	5	1321-RWR12-DP
	5.5	7.5	1321-RWR18-DP
	7.5	10	1321-RWR25-DP
	11	15	1321-RWR25-DP
	15	20	1321-RWR35-DP
	18.5	25	1321-RWR45-DP
	22	30	1321-RWR55-DP
500... 600V AC	4	5	1321-RWR8-EP
	5.5	7.5	1321-RWR12-EP
	7.5	10	1321-RWR18-EP
	11	15	1321-RWR25-EP

**Reflected Wave Reduction Module with Common Mode Choke**

Description ★	Cat. No.
17A with Common Mode Choke	1204-RWC-17-A

★ For selection information, refer to Appendix A of the Wiring and Grounding Guidelines for Pulse Width Modulated (PWM) AC Drives, publication Drives-IN001.



## Dynamic Brake Resistors

Voltage	Drive Rating		Minimum Resistance	Resistance	Cat. No. ‡ §
	kW	Hp	Ohms, ±10%	Ohms, ±5%	
100...120V, 50/60 Hz, Single-Phase	0.4	0.5	60	91	AK-R2-091P500
	0.75	1	60	91	AK-R2-091P500
	1.1	1.5	48	91	AK-R2-091P500
200...240V, 50/60 Hz, Single-Phase	0.4	0.5	60	91	AK-R2-091P500
	0.75	1	60	91	AK-R2-091P500
	1.5	2	48	91	AK-R2-091P500
	2.2	3	32	47	AK-R2-047P500
200...240V, 50/60 Hz, Three-Phase	0.4	0.5	60	91	AK-R2-091P500
	0.75	1	60	91	AK-R2-091P500
	1.5	2	60	91	AK-R2-091P500
	2.2	3	32	47	AK-R2-047P500
	3.7	5	19	47	AK-R2-047P500
	5.5	7.5	19	30	AK-R2-030P1K2
	7.5	10	15	30	AK-R2-030P1K2
	11	15	15	15	AK-R2-030P1K2 ♣
380...480V, 50/60 Hz, Three-Phase	0.4	0.5	97	360	AK-R2-360P500
	0.75	1	97	360	AK-R2-360P500
	1.5	2	97	360	AK-R2-360P500
	2.2	3	97	120	AK-R2-120P1K2
	4.0	5	77	120	AK-R2-120P1K2
	5.5	7.5	55	120	AK-R2-120P1K2
	7.5	10	55	120	AK-R2-120P1K2
	11	15	50	60	AK-R2-120P1K2 ♣
	15	20	50	60	AK-R2-120P1K2 ♣
	18.5	25	30	40	AK-R2-120P1K2 Δ
500...600V, 50/60 Hz, Three-Phase	0.4	0.5	120	360	AK-R2-360P500
	0.75	1	120	360	AK-R2-360P500
	1.5	2	120	360	AK-R2-360P500
	2.2	3	120	120	AK-R2-120P1K2
	3.7	5	82	120	AK-R2-120P1K2
	5.5	7.5	65	120	AK-R2-120P1K2
	7.5	10	65	120	AK-R2-120P1K2
	11	15	65	60	AK-R2-120P1K2 ♣
	15	20	65	60	AK-R2-120P1K2 ♣
	18.5	25	60	60	AK-R2-120P1K2 ♣
	22	30	38	40	AK-R2-120P1K2 Δ

‡ Resistors listed are rated 5% duty cycle.

§ Use of Rockwell Automation resistors is recommended. The resistors listed have been carefully selected for optimizing performance in a variety of applications. Alternative resistors may be used, however, care must be taken when making a selection. Refer to the PowerFlex Dynamic Braking Resistor Calculator, publication PFLEX-AT001.

♣ Requires two resistors wired in parallel.

Δ Requires three resistors wired in parallel.

## Line Reactors - 3% Impedance

Voltage	Drive Ratings			IP00 ★ (NEMA/UL Open Type)	IP11 ★ (NEMA/UL Type 1)
	kW	Hp	Amps	Cat. No.	Cat. No.
200...240V, 60 Hz, Three-Phase	0.4	0.5	4.0	1321-3R4-B	1321-3RA4-B
	0.75	1	8.0	1321-3R8-B	1321-3RA8-B
	1.5	2	8.0	1321-3R8-A	1321-3RA8-A
	2.2	3	12	1321-3R12-A	1321-3RA12-A
	3.7	5	17.5	1321-3R18-A	1321-3RA18-A
	5.5	7.5	24	1321-3R25-A	1321-3RA25-A
	7.5	10	33	1321-3R35-A	1321-3RA35-A
	15	15	49	1321-3R45-A	1321-3RA45-A
380...480V, 60 Hz, Three-Phase	0.4	0.5	2.0	1321-3R2-B	1321-3RA2-B
	0.75	1	4.0	1321-3R4-C	1321-3RA4-C
	1.5	2	4.0	1321-3R4-B	1321-3RA4-B
	2.2	3	6.0	1321-3R8-C	1321-3RA8-C
	4.0	5	10.5	1321-3R8-B	1321-3RA8-B
	5.5	7.5	12	1321-3R12-B	1321-3RA12-B
	7.5	10	17	1321-3R18-B	1321-3RA18-B
	11	15	22	1321-3R25-B	1321-3RA25-B
	15	20	30	1321-3R35-B	1321-3RA35-B
	18.5	25	38	1321-3R35-B	1321-3RA35-B
	22	30	45.5	1321-3R45-B	1321-3RA45-B
500...600V, 60 Hz, Three-Phase	0.75	1	2.0	1321-3R2-B	1321-3RA2-B
	1.5	2	4.0	1321-3R4-C	1321-3RA4-C
	2.2	3	4.0	1321-3R4-B	1321-3RA4-B
	4.0	5	8.0	1321-3R8-C	1321-3RA8-C
	5.5	7.5	12	1321-3R12-B	1321-3RA12-B
	7.5	10	12	1321-3R12-B	1321-3RA12-B
	11	15	18	1321-3R18-B	1321-3RA18-B
	15	20	25	1321-3R25-B	1321-3RA25-B
	18.5	25	35	1321-3R35-C	1321-3RA35-C
22	30	35	1321-3R35-B	1321-3RA35-B	

★ Catalog numbers listed are for 3% impedance. 5% impedance reactor types are also available. Refer to 1321 Power Conditioning Products Technical Data, publication 1321-TD001.

# PowerFlex 70 AC Drive

The PowerFlex 70 offers a compact package of power, control and operator interface, designed to meet the demands for space, simplicity and reliability. This drive provides a broad spectrum of features, allowing you to easily integrate it into your architecture and configure it for most application needs.

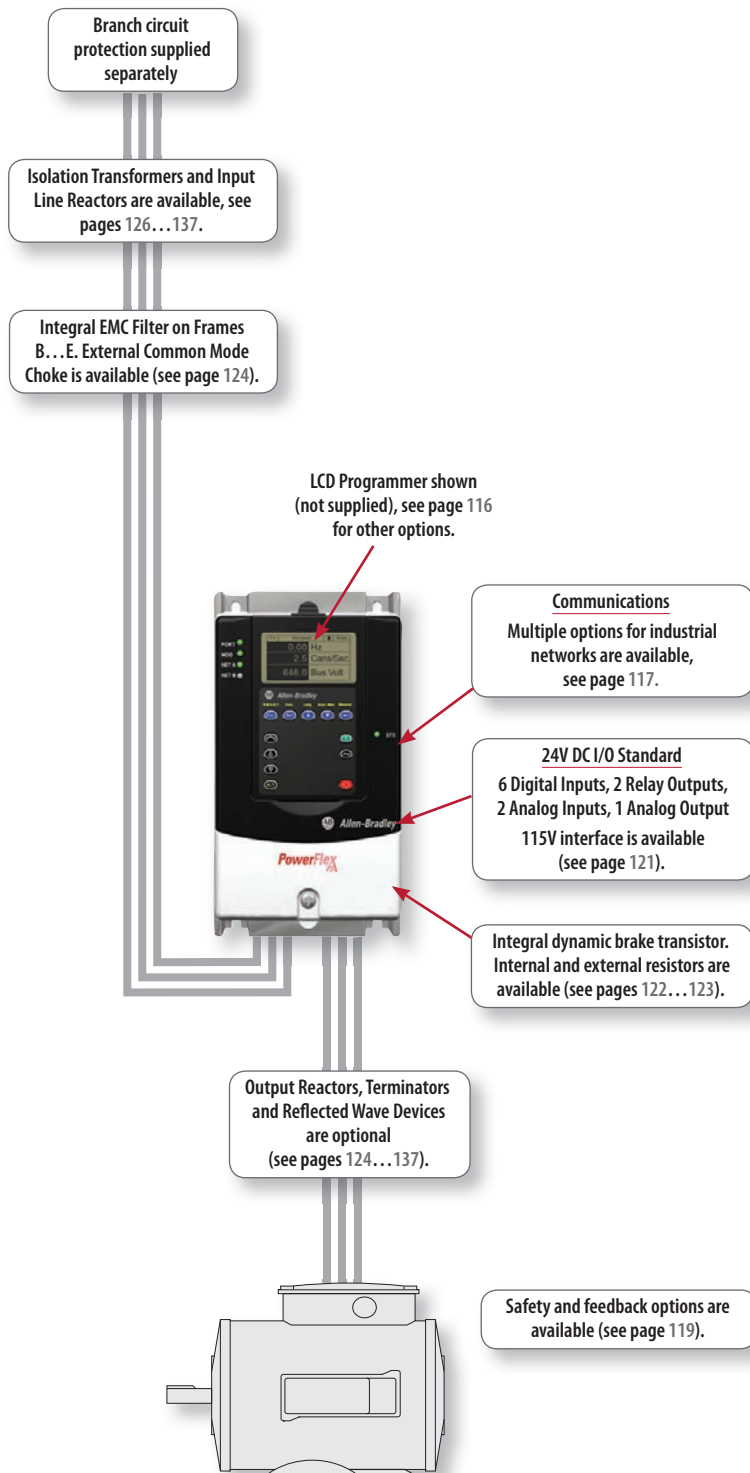

## PowerFlex 70 at a glance

### Ratings

200...240V:	0.37...18.5 kW / 0.5...25 Hp / 2.2...70 A
380...480V:	0.37...37 kW / 0.5...50 Hp / 1.1...72 A
500...600V:	0.5...50 Hp / 0.9...52 A

### Motor Control

- V/Hz Control
- Sensorless Vector Control
- Vector Control with FORCE Technology (with and without encoder)

### Enclosures

- IP20, NEMA/UL Type 1
- Flange Mount
- IP54, NEMA/UL Type 12
- IP66, NEMA/UL Type 4X/12 for indoor use

### Safety

DriveGuard Safe Torque-Off / EN 954-1 Cat. 3

### Additional Features

- Speed and torque control with and without encoder feedback
- Pjump and Traverse for Fibers application

### Certifications

- ABS
- C-Tick (excluding 600V)
- c-UL-us
- CE ★
- IEC (Designed to Meet)
- Lloyd's Register
- NSF Certified (IP66, NEMA/UL Type 4X/12 only)
- EPRI/SEMI F47
- TÜV FS ISO/EN13849-1 (EN954-1) with Safe Torque-Off option

### Options

See pages 116...137

★ CE certification testing has not been performed on 600V drives.

## Additional Information

PowerFlex 70 Technical Data, publication 20A-TD001

PowerFlex 70 User Manual, publication 20A-UM001

## Catalog Number Explanation

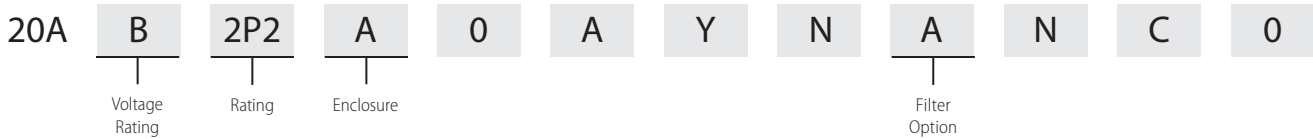

## Product Selection

Panel Mount - IP20, NEMA/UL Type 1, No HIM

### 200...240V AC, Three-Phase Drives

240V AC Input						208V AC Input ‡						with Filter	Frame Size
Output Amps			Normal Duty Hp	Heavy Duty Hp	Cat. No.	Output Amps			Normal Duty kW	Heavy Duty kW	Cat. No.		
Cont.	1 Min.	3 Sec.				Cont.	1 Min.	3 Sec.					
2.2	2.4	3.3	0.5	0.33	20AB2P2A0AYNNNCO	2.5	2.7	3.7	0.37	0.25	20AB2P2A0AYNNNCO	N	A
2.2	2.4	3.3	0.5	0.33	20AB2P2A0AYNANCO	2.5	2.7	3.7	0.37	0.25	20AB2P2A0AYNANCO	Y	B
4.2	4.8	6.4	1	0.75	20AB4P2A0AYNNNCO	4.8	5.5	7.4	0.75	0.55	20AB4P2A0AYNNNCO	N	A
4.2	4.8	6.4	1	0.75	20AB4P2A0AYNANCO	4.8	5.5	7.4	0.75	0.55	20AB4P2A0AYNANCO	Y	B
6.8	9	12	2	1.5	20AB6P8A0AYNNNCO	7.8	10.3	13.8	1.5	1.1	20AB6P8A0AYNNNCO	N	B
6.8	9	12	2	1.5	20AB6P8A0AYNANCO	7.8	10.3	13.8	1.5	1.1	20AB6P8A0AYNANCO	Y	B
9.6	10.6	14.4	3	2	20AB9P6A0AYNNNCO	11	12.1	16.5	2.2	1.5	20AB9P6A0AYNNNCO	N	B
9.6	10.6	14.4	3	2	20AB9P6A0AYNANCO	11	12.1	16.5	2.2	1.5	20AB9P6A0AYNANCO	Y	B
15.3	17.4	23.2	5	3	20AB015A0AYNANCO	17.5	19.2	26.2	4	3	20AB015A0AYNANCO	Y	C
22	24.2	33	7.5	5	20AB022A0AYNANCO	25.3	27.8	37.9	5.5	4	20AB022A0AYNANCO	Y	D
28	33	44	10	7.5	20AB028A0AYNANCO	32.2	37.9	50.6	7.5	5.5	20AB028A0AYNANCO	Y	D
42	46.2	63	15	10	20AB042A0AYNANCO	43	55.5	74	11	7.5	20AB042A0AYNANCO	Y	D
54	63	84	20	15	20AB054A0AYNANCO	62.1	72.4	96.6	15	11	20AB054A0AYNANCO	Y	E
70	81	108	25	20	20AB070A0AYNANCO	78.2	93.1	124	18.5	15	20AB070A0AYNANCO	Y	E

‡ Drive must be programmed to lower voltage to obtain the currents shown.

## Panel Mount - IP20, NEMA/UL Type 1, No HIM (continued)

## 380...480V AC, Three-Phase Drives

480V AC Input						400V AC Input						with Filter	Frame Size
Output Amps			Normal Duty Hp	Heavy Duty Hp	Cat. No.	Output Amps			Normal Duty kW	Heavy Duty kW	Cat. No.		
Cont.	1 Min.	3 Sec.				Cont.	1 Min.	3 Sec.					
1.1	1.2	1.6	0.5	0.33	20AD1P1A0AYNNNCO	1.3	1.4	1.9	0.37	0.25	20AC1P3A0AYNNNCO	N	A
1.1	1.2	1.6	0.5	0.33	20AD1P1A0AYNNANCO	1.3	1.4	1.9	0.37	0.25	20AC1P3A0AYNNANCO	Y	B
2.1	2.4	3.2	1	0.75	20AD2P1A0AYNNNCO	2.1	2.4	3.2	0.75	0.55	20AC2P1A0AYNNNCO	N	A
2.1	2.4	3.2	1	0.75	20AD2P1A0AYNNANCO	2.1	2.4	3.2	0.75	0.55	20AC2P1A0AYNNANCO	Y	B
3.4	4.5	6	2	1.5	20AD3P4A0AYNNNCO	3.5	4.5	6	1.5	1.1	20AC3P5A0AYNNNCO	N	A
3.4	4.5	6	2	1.5	20AD3P4A0AYNNANCO	3.5	4.5	6	1.5	1.1	20AC3P5A0AYNNANCO	Y	B
5	5.5	7.5	3	2	20AD5P0A0AYNNNCO	5	5.5	7.5	2.2	1.5	20AC5P0A0AYNNNCO	N	B
5	5.5	7.5	3	2	20AD5P0A0AYNNANCO	5	5.5	7.5	2.2	1.5	20AC5P0A0AYNNANCO	Y	B
8	8.8	12	5	3	20AD8P0A0AYNNNCO	8.7	9.9	13.2	4	3	20AC8P7A0AYNNNCO	N	B
8	8.8	12	5	3	20AD8P0A0AYNNANCO	8.7	9.9	13.2	4	3	20AC8P7A0AYNNANCO	Y	B
11	12.1	16.5	7.5	5	20AD011A0AYNNANCO	11.5	13	17.4	5.5	4	20AC011A0AYNNANCO	Y	C
14	16.5	22	10	7.5	20AD014A0AYNNANCO	15	17.2	23.1	7.5	5.5	20AC015A0AYNNANCO	Y	C
22	24.2	33	15	10	20AD022A0AYNNANCO	22	24.2	33	11	7.5	20AC022A0AYNNANCO	Y	D
27	33	44	20	15	20AD027A0AYNNANCO	30	33	45	15	11	20AC030A0AYNNANCO	Y	D
34	40.5	54	25	20	20AD034A0AYNNANCO	37	45	60	18.5	15	20AC037A0AYNNANCO	Y	D
40	51	68	30	25	20AD040A0AYNNANCO	43	56	74	22	18.5	20AC043A0AYNNANCO	Y	D
52	60	80	40	30	20AD052A0AYNNANCO	60	66	90	30	22	20AC060A0AYNNANCO	Y	E
65	78	104	50	40	20AD065A0AYNNANCO	72	90	120	37	30	20AC072A0AYNNANCO	Y	E

## 500...600V AC, Three-Phase Drives

600V AC Input							
Output Amps			Normal Duty Hp	Heavy Duty Hp	Cat. No.	with Filter	Frame Size
Cont.	1 Min.	3 Sec.					
0.9	1	1.4	0.5	0.33	20AE0P9A0AYNNNCO	N	A
1.7	1.9	2.6	1	0.75	20AE1P7A0AYNNNCO	N	A
2.7	3.6	4.8	2	1	20AE2P7A0AYNNNCO	N	A
3.9	4.3	5.8	3	1.5	20AE3P9A0AYNNNCO	N	B
6.1	6.7	9.1	5	3	20AE6P1A0AYNNNCO	N	B
9	9.9	13.5	7.5	5	20AE9P0A0AYNNNCO	N	C
11	13.5	18	10	7.5	20AE011A0AYNNNCO	N	C
17	18.7	25.5	15	10	20AE017A0AYNNNCO	N	D
22	25.5	34	20	15	20AE022A0AYNNNCO	N	D
27	33	44	25	20	20AE027A0AYNNNCO	N	D
32	40.5	54	30	25	20AE032A0AYNNNCO	N	D
41	48	64	40	30	20AE041A0AYNNANCO	N	E
52	61.5	82	50	40	20AE052A0AYNNANCO	N	E



Wall/Machine Mount - IP66, NEMA/UL Type 4X/12 for Indoor Use with HIM

200...240V AC, Three-Phase Drives

240V AC Input						208V AC Input ‡						with Filter	Frame Size
Output Amps			Normal Duty Hp	Heavy Duty Hp	Cat. No.	Output Amps			Normal Duty kW	Heavy Duty kW	Cat. No.		
Cont.	1 Min.	3 Sec.				Cont.	1 Min.	3 Sec.					
2.2	2.4	3.3	0.5	0.33	20AB2P2C3AYNNNCO	2.5	2.7	3.7	0.37	0.25	20AB2P2C3AYNNNCO	N	B
2.2	2.4	3.3	0.5	0.33	20AB2P2C3AYNANCO	2.5	2.7	3.7	0.37	0.25	20AB2P2C3AYNANCO	Y	B
4.2	4.8	6.4	1	0.75	20AB4P2C3AYNNNCO	4.8	5.5	7.4	0.75	0.55	20AB4P2C3AYNNNCO	N	B
4.2	4.8	6.4	1	0.75	20AB4P2C3AYNANCO	4.8	5.5	7.4	0.75	0.55	20AB4P2C3AYNANCO	Y	B
6.8	9	12	2	1.5	20AB6P8C3AYNNNCO	7.8	10.3	13.8	1.5	1.1	20AB6P8C3AYNNNCO	N	B
6.8	9	12	2	1.5	20AB6P8C3AYNANCO	7.8	10.3	13.8	1.5	1.1	20AB6P8C3AYNANCO	Y	B
9.6	10.6	14.4	3	2	20AB9P6C3AYNNNCO	11	12.1	16.5	2.2	1.5	20AB9P6C3AYNNNCO	N	B
9.6	10.6	14.4	3	2	20AB9P6C3AYNANCO	11	12.1	16.5	2.2	1.5	20AB9P6C3AYNANCO	Y	B
15.3	17.4	23.2	5	3	20AB015C3AYNANCO	17.5	19.2	26.2	4	3	20AB015C3AYNANCO	Y	D
22	24.2	33	7.5	5	20AB022C3AYNANCO	25.3	27.8	37.9	5.5	4	20AB022C3AYNANCO	Y	D
28	33	44	10	7.5	20AB028C3AYNANCO	32.2	37.9	50.6	7.5	5.5	20AB028C3AYNANCO	Y	D
42	46.2	63	15	10	20AB042C3AYNANCO	43	55.5	74	11	7.5	20AB042C3AYNANCO	Y	D
54	63	84	20	15	20AB054C3AYNANCO	62.1	72.4	96.6	15	11	20AB054C3AYNANCO	Y	E
70	81	108	25	20	20AB070C3AYNANCO	78.2	93.1	124	18.5	15	20AB070C3AYNANCO	Y	E

‡ Drive must be programmed to lower voltage to obtain the currents shown.

380...480V AC, Three-Phase Drives

480V AC Input						400V AC Input						with Filter	Frame Size
Output Amps			Normal Duty Hp	Heavy Duty Hp	Cat. No.	Output Amps			Normal Duty kW	Heavy Duty kW	Cat. No.		
Cont.	1 Min.	3 Sec.				Cont.	1 Min.	3 Sec.					
1.1	1.2	1.6	0.5	0.33	20AD1P1C3AYNNNCO	1.3	1.4	1.9	0.37	0.25	20AC1P3C3AYNNNCO	N	B
1.1	1.2	1.6	0.5	0.33	20AD1P1C3AYNANCO	1.3	1.4	1.9	0.37	0.25	20AC1P3C3AYNANCO	Y	B
2.1	2.4	3.2	1	0.75	20AD2P1C3AYNNNCO	2.1	2.4	3.2	0.75	0.55	20AC2P1C3AYNNNCO	N	B
2.1	2.4	3.2	1	0.75	20AD2P1C3AYNANCO	2.1	2.4	3.2	0.75	0.55	20AC2P1C3AYNANCO	Y	B
3.4	4.5	6	2	1.5	20AD3P4C3AYNNNCO	3.5	4.5	6	1.5	1.1	20AC3P5C3AYNNNCO	N	B
3.4	4.5	6	2	1.5	20AD3P4C3AYNANCO	3.5	4.5	6	1.5	1.1	20AC3P5C3AYNANCO	Y	B
5	5.5	7.5	3	2	20AD5P0C3AYNNNCO	5	5.5	7.5	2.2	1.5	20AC5P0C3AYNNNCO	N	B
5	5.5	7.5	3	2	20AD5P0C3AYNANCO	5	5.5	7.5	2.2	1.5	20AC5P0C3AYNANCO	Y	B
8	8.8	12	5	3	20AD8P0C3AYNNNCO	8.7	9.9	13.2	4	3	20AC8P7C3AYNNNCO	N	B
8	8.8	12	5	3	20AD8P0C3AYNANCO	8.7	9.9	13.2	4	3	20AC8P7C3AYNANCO	Y	B
11	12.1	16.5	7.5	5	20AD011C3AYNANCO	11.5	13	17.4	5.5	4	20AC011C3AYNANCO	Y	D
14	16.5	22	10	7.5	20AD014C3AYNANCO	15	17.2	23.1	7.5	5.5	20AC015C3AYNANCO	Y	D
22	24.2	33	15	10	20AD022C3AYNANCO	22	24.2	33	11	7.5	20AC022C3AYNANCO	Y	D
27	33	44	20	15	20AD027C3AYNANCO	30	33	45	15	11	20AC030C3AYNANCO	Y	D
34	40.5	54	25	20	20AD034C3AYNANCO	37	45	60	18.5	15	20AC037C3AYNANCO	Y	D
40	51	68	30	25	20AD040C3AYNANCO	43	56	74	22	18.5	20AC043C3AYNANCO	Y	D
52	60	80	40	30	20AD052C3AYNANCO	60	66	90	30	22	20AC060C3AYNANCO	Y	E
65	78	104	50	40	20AD065C3AYNANCO	72	90	120	37	30	20AC072C3AYNANCO	Y	E

## Wall / Machine Mount - IP66, NEMA/UL Type 4X/12 for Indoor Use with HIM (continued)

## 500...600V AC, Three-Phase Drives

600V AC Input						with Filter	Frame Size
Output Amps			Normal Duty Hp	Heavy Duty Hp	Cat. No.		
Cont.	1 Min.	3 Sec.					
0.9	1	1.4	0.5	0.33	20AEP9C3AYNNNCO	N	B
1.7	1.9	2.6	1	0.75	20AE1P7C3AYNNNCO	N	B
2.7	3.6	4.8	2	1	20AE2P7C3AYNNNCO	N	B
3.9	4.3	5.8	3	1.5	20AE3P9C3AYNNNCO	N	B
6.1	6.7	9.1	5	3	20AE6P1C3AYNNNCO	N	B
9	9.9	13.5	7.5	5	20AE9POC3AYNNNCO	N	D
11	13.5	18	10	7.5	20AE011C3AYNNNCO	N	D
17	18.7	25.5	15	10	20AE017C3AYNNNCO	N	D
22	25.5	34	20	15	20AE022C3AYNNNCO	N	D
27	33	44	25	20	20AE027C3AYNNNCO	N	D
32	40.5	54	30	25	20AE032C3AYNNNCO	N	D
41	48	64	40	30	20AE041C3AYNNNCO	N	E
52	61.5	82	50	40	20AE052C3AYNNNCO	N	E

## Wall / Machine Mount - IP54, NEMA/UL Type 12, with HIM

## 200...240V AC, Three-Phase Drives

240V AC Input					208V AC Input ‡					Cat. No.	with Filter	Frame Size
Output Amps			Normal Duty Hp	Heavy Duty Hp	Output Amps			Normal Duty kW	Heavy Duty kW			
Cont.	1 Min.	3 Sec.			Cont.	1 Min.	3 Sec.					
54	63	84	20	15	62.1	72.4	96.6	15	11	20AB054G3AYNNANCO	Y	E
70	81	108	25	20	78.2	93.1	124	18.5	15	20AB070G3AYNNANCO	Y	E

‡ Drive must be programmed to lower voltage to obtain the currents shown.

## 380...480V AC, Three-Phase Drives

480V AC Input						400V AC Input					with Filter	Frame Size	
Output Amps			Normal Duty Hp	Heavy Duty Hp	Cat. No.	Output Amps			Normal Duty kW	Heavy Duty kW			Cat. No.
Cont.	1 Min.	3 Sec.				Cont.	1 Min.	3 Sec.					
52	60	80	40	30	20AD052G3AYNNANCO	60	66	90	30	22	20AC060G3AYNNANCO	Y	E
65	78	104	50	40	20AD065G3AYNNANCO	72	90	120	37	30	20AC072G3AYNNANCO	Y	E

## 500...600V AC, Three-Phase Drives

600V AC Input						with Filter	Frame Size
Output Amps			Normal Duty Hp	Heavy Duty Hp	Cat. No.		
Cont.	1 Min.	3 Sec.					
41	48	64	40	30	20AE041G3AYNNANCO	Y	E
52	61.5	82	50	40	20AE052G3AYNNANCO	Y	E

Flange Mount

Front Chassis = IP20, NEMA/UL Type 1, Heatsink = IP66, NEMA/UL Type 4X/12, No HIM

200...240V AC, Three-Phase Drives

240V AC Input						208V AC Input ‡						with Filter	Frame Size
Output Amps			Normal Duty Hp	Heavy Duty Hp	Cat. No.	Output Amps			Normal Duty kW	Heavy Duty kW	Cat. No.		
Cont.	1 Min.	3 Sec.				Cont.	1 Min.	3 Sec.					
2.2	2.4	3.3	0.5	0.33	20AB2P2FOAYNNNCO	2.5	2.7	3.7	0.37	0.25	20AB2P2FOAYNNNCO	N	A
2.2	2.4	3.3	0.5	0.33	20AB2P2FOAYNNANCO	2.5	2.7	3.7	0.37	0.25	20AB2P2FOAYNNANCO	Y	B
4.2	4.8	6.4	1	0.75	20AB4P2FOAYNNNCO	4.8	5.5	7.4	0.75	0.55	20AB4P2FOAYNNNCO	N	A
4.2	4.8	6.4	1	0.75	20AB4P2FOAYNNANCO	4.8	5.5	7.4	0.75	0.55	20AB4P2FOAYNNANCO	Y	B
6.8	9	12	2	1.5	20AB6P8FOAYNNNCO	7.8	10.3	13.8	1.5	1.1	20AB6P8FOAYNNNCO	N	B
6.8	9	12	2	1.5	20AB6P8FOAYNNANCO	7.8	10.3	13.8	1.5	1.1	20AB6P8FOAYNNANCO	Y	B
9.6	10.6	14.4	3	2	20AB9P6FOAYNNNCO	11	12.1	16.5	2.2	1.5	20AB9P6FOAYNNNCO	N	B
9.6	10.6	14.4	3	2	20AB9P6FOAYNNANCO	11	12.1	16.5	2.2	1.5	20AB9P6FOAYNNANCO	Y	B
15.3	17.4	23.2	5	3	20AB015FOAYNNANCO	17.5	19.2	26.2	4	3	20AB015FOAYNNANCO	Y	C
22	24.2	33	7.5	5	20AB022FOAYNNANCO	25.3	27.8	37.9	5.5	4	20AB022FOAYNNANCO	Y	D
28	33	44	10	7.5	20AB028FOAYNNANCO	32.2	37.9	50.6	7.5	5.5	20AB028FOAYNNANCO	Y	D
42	46.2	63	15	10	20AB042FOAYNNANCO	43	55.5	74	11	7.5	20AB042FOAYNNANCO	Y	D
54	63	84	20	15	20AB054FOAYNNANCO	62.1	72.4	96.6	15	11	20AB054FOAYNNANCO	Y	E
70	81	108	25	20	20AB070FOAYNNANCO	78.2	93.1	124	18.5	15	20AB070FOAYNNANCO	Y	E

‡ Drive must be programmed to lower voltage to obtain the currents shown.

380...480V AC, Three-Phase Drives

480V AC Input						400V AC Input						with Filter	Frame Size
Output Amps			Normal Duty Hp	Heavy Duty Hp	Cat. No.	Output Amps			Normal Duty kW	Heavy Duty kW	Cat. No.		
Cont.	1 Min.	3 Sec.				Cont.	1 Min.	3 Sec.					
1.1	1.2	1.6	0.5	0.33	20AD1P1FOAYNNNCO	1.3	1.4	1.9	0.37	0.25	20AC1P3FOAYNNNCO	N	A
1.1	1.2	1.6	0.5	0.33	20AD1P1FOAYNNANCO	1.3	1.4	1.9	0.37	0.25	20AC1P3FOAYNNANCO	Y	B
2.1	2.4	3.2	1	0.75	20AD2P1FOAYNNNCO	2.1	2.4	3.2	0.75	0.55	20AC2P1FOAYNNNCO	N	A
2.1	2.4	3.2	1	0.75	20AD2P1FOAYNNANCO	2.1	2.4	3.2	0.75	0.55	20AC2P1FOAYNNANCO	Y	B
3.4	4.5	6	2	1.5	20AD3P4FOAYNNNCO	3.5	4.5	6	1.5	1.1	20AC3P5FOAYNNNCO	N	A
3.4	4.5	6	2	1.5	20AD3P4FOAYNNANCO	3.5	4.5	6	1.5	1.1	20AC3P5FOAYNNANCO	Y	B
5	5.5	7.5	3	2	20AD5P0FOAYNNNCO	5	5.5	7.5	2.2	1.5	20AC5P0FOAYNNNCO	N	B
5	5.5	7.5	3	2	20AD5P0FOAYNNANCO	5	5.5	7.5	2.2	1.5	20AC5P0FOAYNNANCO	Y	B
8	8.8	12	5	3	20AD8P0FOAYNNNCO	8.7	9.9	13.2	4	3	20AC8P7FOAYNNNCO	N	B
8	8.8	12	5	3	20AD8P0FOAYNNANCO	8.7	9.9	13.2	4	3	20AC8P7FOAYNNANCO	Y	B
11	12.1	16.5	7.5	5	20AD011FOAYNNANCO	11.5	13	17.4	5.5	4	20AC011FOAYNNANCO	Y	C
14	16.5	22	10	7.5	20AD014FOAYNNANCO	15	17.2	23.1	7.5	5.5	20AC015FOAYNNANCO	Y	C
22	24.2	33	15	10	20AD022FOAYNNANCO	22	24.2	33	11	7.5	20AC022FOAYNNANCO	Y	D
27	33	44	20	15	20AD027FOAYNNANCO	30	33	45	15	11	20AC030FOAYNNANCO	Y	D
34	40.5	54	25	20	20AD034FOAYNNANCO	37	45	60	18.5	15	20AC037FOAYNNANCO	Y	D
40	51	68	30	25	20AD040FOAYNNANCO	43	56	74	22	18.5	20AC043FOAYNNANCO	Y	D
52	60	80	40	30	20AD052FOAYNNANCO	60	66	90	30	22	20AC060FOAYNNANCO	Y	E
65	78	104	50	40	20AD065FOAYNNANCO	72	90	120	37	30	20AC072FOAYNNANCO	Y	E

## Flange Mount

Front Chassis = IP20, NEMA/UL Type 1, Heatsink = IP66, NEMA/UL Type 4X/12, No HIM (continued)

### 500...600V AC, Three-Phase Drives

Output Amps			600V AC Input			with Filter	Frame Size
Cont.	1 Min.	3 Sec.	Normal Duty Hp	Heavy Duty Hp	Cat. No.		
0.9	1	1.4	0.5	0.33	20AE0P9F0AYNNNCO	N	A
1.7	1.9	2.6	1	0.75	20AE1P7F0AYNNNCO	N	A
2.7	3.6	4.8	2	1	20AE2P7F0AYNNNCO	N	A
3.9	4.3	5.8	3	1.5	20AE3P9F0AYNNNCO	N	B
6.1	6.7	9.1	5	3	20AE6P1F0AYNNNCO	N	B
9	9.9	13.5	7.5	5	20AE9P0F0AYNNNCO	N	C
11	13.5	18	10	7.5	20AE011F0AYNNNCO	N	C
17	18.7	25.5	15	10	20AE017F0AYNNNCO	N	D
22	25.5	34	20	15	20AE022F0AYNNNCO	N	D
27	33	44	25	20	20AE027F0AYNNNCO	N	D
32	40.5	54	30	25	20AE032F0AYNNNCO	N	D
41	48	64	40	30	20AE041F0AYNANCO	N	E
52	61.5	82	50	40	20AE052F0AYNANCO	N	E

## Approximate Dimensions and Weights

Dimensions are in mm (in.) - weights are in kg (lb)

### IP20, NEMA/UL Type 1

Frame	H	W	D	Weight ★
A	225.7 (8.89)	122.4 (4.82)	179.8 (7.08)	2.71 (6.0)
B	234.6 (9.24)	171.7 (6.76)	179.8 (7.08)	3.60 (7.9)
C	300.0 (11.81)	185.0 (7.28)	179.8 (7.08)	6.89 (15.2)
D	350.0 (13.78)	219.9 (8.66)	179.8 (7.08)	9.25 (20.4)
E	555.8 (21.88)	280.3 (11.04)	207.1 (8.15)	18.60 (41.0)

★ Weights include HIM and I/O.

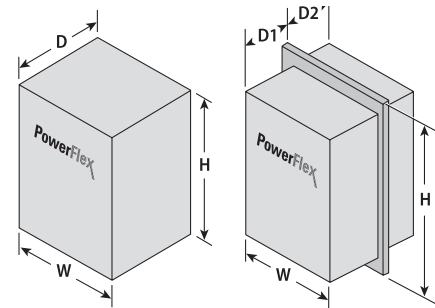

### IP66, NEMA/UL Type 4X/12 for Indoor Use

Frame	H	W	D	Weight ★
B	239.8 (9.44)	171.7 (6.76)	203.3 (8.00)	3.61 (8.0)
D	350.0 (13.78)	219.9 (8.66)	210.7 (8.29)	9.13 (20.1)
E	555.8 (21.88)	280.3 (11.04)	219.8 (8.65)	18.6 (41.0)

★ Weights include HIM and I/O.

## Flange Mount

Frame	H	W	D1	D2	Weight ★
A	225.8 (8.89)	156.0 (6.14)	123.0 (4.84)	55.6 (2.19)	2.71 (6.0)
B	234.6 (9.24)	205.2 (8.08)	123.0 (4.84)	55.6 (2.19)	3.60 (7.9)
C	300.0 (11.81)	219.0 (8.62)	123.0 (4.84)	55.6 (2.19)	6.89 (15.2)
D	350.0 (13.78)	248.4 (9.78)	123.0 (4.84)	55.6 (2.19)	9.25 (20.4)
E	555.8 (21.88)	280.3 (11.04)	117.2 (4.61)	89.9 (3.54)	18.60 (41.0)

★ Weights include HIM and I/O.

# PowerFlex 700 AC Drive

The PowerFlex 700 offers outstanding performance in an easy-to-use drive that covers a wide range of horsepower ratings. This drive is designed to control three-phase induction motors in applications with requirements ranging from the simplest speed control to the most demanding torque control. The PowerFlex 700 offers application specific features and parameters for lifting, oil wells, and speed and positioning applications.

## PowerFlex 700 at a glance

### Ratings

200...240V:	0.37...66 kW / 0.5...100 Hp / 2.2...260 A
380...480V:	0.37...500 kW / 0.5...700 Hp / 1.1...875 A
500...600V:	1...150 Hp / 1.7...144 A
690V:	45...132 kW / 52...142 A

### Motor Control

- V/Hz Control
- Sensorless Vector Control
- Vector Control with FORCE Technology (with and without encoder)

### Enclosures

- IP00, NEMA/UL Type Open
- IP20, NEMA/UL Type 1
- IP54, NEMA 12
- Flange Mount

### Additional Features

- Speed and torque control with and without encoder feedback
- Position indexing and speed profiling
- Parameter linking functionality
- TorqProve for lifting applications
- Adjustable voltage for non-motor loads
- Position regulator and 16 step indexing table (with encoder feedback)
- Custom Firmware including Pump Off for oil well applications and Cascade fan/pump ‡

### Certifications

- ABS (Frames 0...6)
- TÜV ATEX Certified
- C-Tick
- c-UL-us
- CE ★
- IEC (Designed to Meet)
- Lloyd's Register (Frames 0...6)
- EPRI/SEMI F47 (Frames 0...6)

### Options

See pages 116...137

★ 600V class drives below 77 Amps (Frames 0-4) are declared to meet the Low Voltage Directive.

‡ Custom firmware is available factory installed or as an option kit. See page 119 for further information.

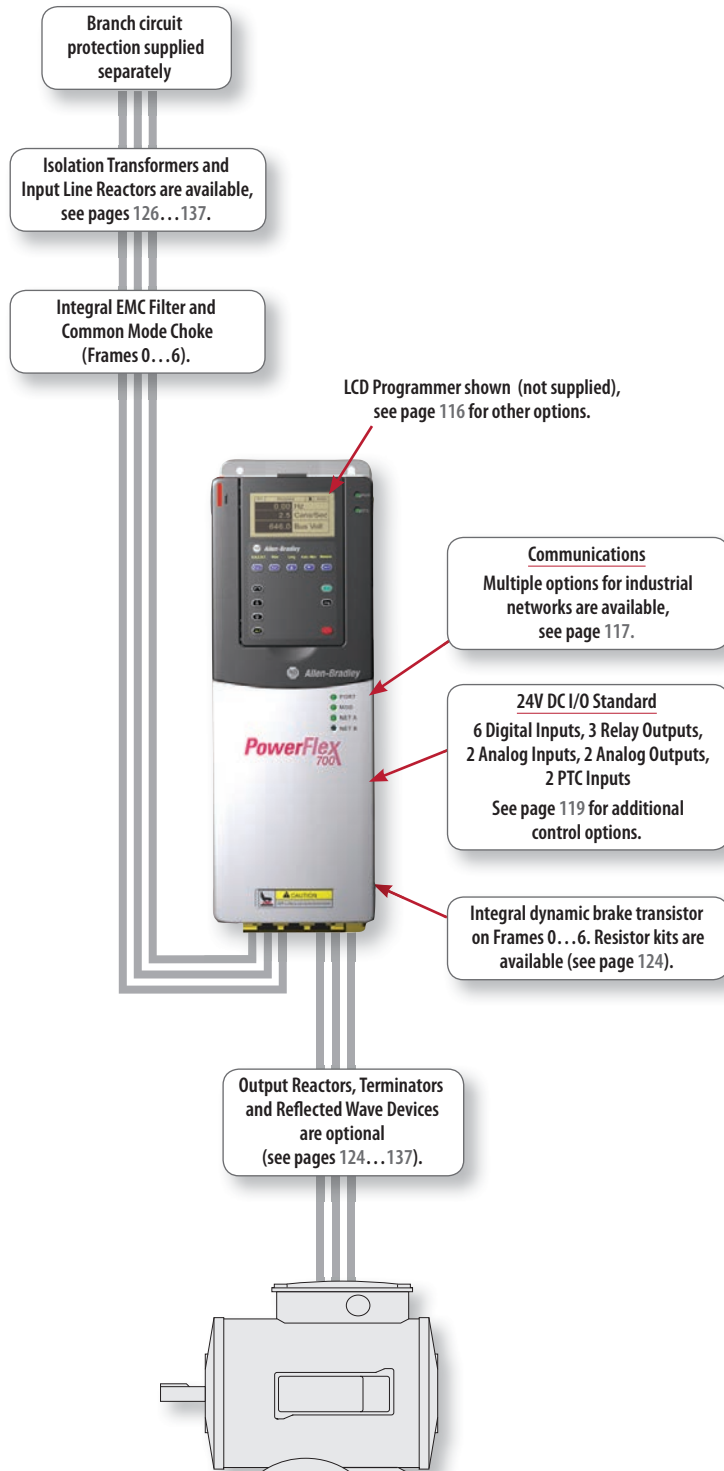



## Additional Information

PowerFlex 700 Technical Data, publication 20B-TD001

PowerFlex 700 User Manual, publication 20B-UM002

## Catalog Number Explanation

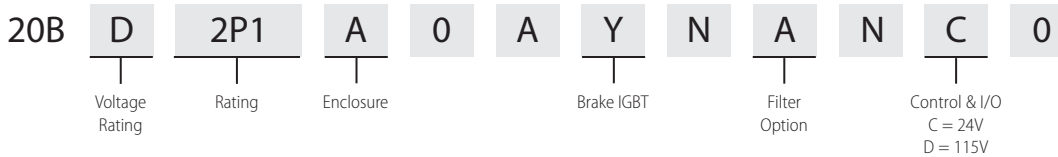

## Product Selection

### Wall Mount - IP20, NEMA/UL Type 1

#### 200...240V AC, Three-Phase Drives

240V AC Input						208V AC Input ★						
Output Amps			Normal Duty Hp	Heavy Duty Hp	Cat. No.	Output Amps			Normal Duty kW	Heavy Duty kW	Cat. No.	Frame Size
Cont.	1 Min.	3 Sec.				Cont.	1 Min.	3 Sec.				
2.2	2.4	3.3	0.5	0.33	20BB2P2A0AYNBNC0	2.5	2.8	3.8	0.37	—	20BB2P2A0AYNBNC0	0
4.2	4.8	6.4	1	0.75	20BB4P2A0AYNBNC0	4.8	5.6	7	0.75	0.37	20BB4P2A0AYNBNC0	0
6.8	9	12	2	1.5	20BB6P8A0AYNBNC0	7.8	10.4	13.8	1.5	0.75	20BB6P8A0AYNBNC0	1
9.6	10.6	14.4	3	2	20BB9P6A0AYNBNC0	11	12.1	17	2.2	1.5	20BB9P6A0AYNBNC0	1
15.3	16.8	23	5	3	20BB015A0AYNBNC0	17.5	19.3	26.3	4	2.2	20BB015A0AYNBNC0	1
22	24.2	33	7.5	5	20BB022A0AYNBNC0	25.3	27.8	38	5.5	4	20BB022A0AYNBNC0	1
28	33	44	10	7.5	20BB028A0AYNBNC0	32.2	38	50.6	7.5	5.5	20BB028A0AYNBNC0	2
42	46.2	63	15	10	20BB042A0AYNBNC0	48.3	53.1	72.5	11	7.5	20BB042A0AYNBNC0	3
52	63	80	20	15	20BB052A0AYNBNC0	56	64	86	15	11	20BB052A0AYNBNC0	3
70	78	105	25	20	20BB070A0ANNANCO	78.2	86	117.3	18.5	15	20BB070A0ANNANCO	4 ♦
80	105	136	30	25	20BB080A0ANNANCO	92	117.3	156.4	22	18.5	20BB080A0ANNANCO	4 ♦
104 (80) ‡	115 (120)	175 (160)	40	30	20BB104A0ANNANCO	120 (92)	132 (138)	175 (175)	30	22	20BB104A0ANNANCO	5 ♦
130 (104) ‡	143 (156)	175 (175)	50	40	20BB130A0ANNANCO	130 (104)	143 (156)	175 (175)	37	30	20BB130A0ANNANCO	5 ♦
154 (130) ‡	169 (195)	231 (260)	60	50	20BB154A0ANNANCO	177 (150)	195 (225)	266 (300)	45	37	20BB154A0ANNANCO	6 ♦
192 (154) ‡	211 (231)	288 (308)	75	60	20BB192A0ANNANCO	221 (177)	243 (266)	308 (308)	55	45	20BB192A0ANNANCO	6 ♦
260 (205) ‡	286 (305)	390 (410)	100	75	20BB260A0ANNANCO	260 (205)	286 (305)	390 (410)	66	55	20BB260A0ANNANCO	6 ♦

★ Drive must be programmed to lower voltage to obtain the currents shown.

‡ These drives have dual current ratings; one for normal duty applications and one for heavy duty applications (in parentheses). The drive may be operated at either rating.

♦ Also available with internal Brake IGBT (20BxxxxA0AYNBNC0).

## Wall Mount - IP20, NEMA/UL Type 1 (continued)

## 380...480V AC, Three-Phase Drives

480V AC Input						400V AC Input						
Output Amps			Normal Duty Hp	Heavy Duty Hp	Cat. No.	Output Amps			Normal Duty kW	Heavy Duty kW	Cat. No.	Frame Size
Cont.	1 Min.	3 Sec.				Cont.	1 Min.	3 Sec.				
1.1	1.2	1.6	0.5	0.33	20BD1P1A0AYNANCO	1.3	1.4	1.9	0.37	0.25	20BC1P3A0AYNANCO	0
2.1	2.4	3.2	1	0.75	20BD2P1A0AYNANCO	2.1	2.4	3.2	0.75	0.55	20BC2P1A0AYNANCO	0
3.4	4.5	6	2	1.5	20BD3P4A0AYNANCO	3.5	4.5	6	1.5	0.75	20BC3P5A0AYNANCO	0
5	5.5	7.5	3	2	20BD5P0A0AYNANCO	5	5.5	7.5	2.2	1.5	20BC5P0A0AYNANCO	0
8	8.8	12	5	3	20BD8P0A0AYNANCO	8.7	9.9	13.2	4	2.2	20BC8P7A0AYNANCO	0
11	12.1	16.5	7.5	5	20BD011A0AYNANCO	11.5	13	17.4	5.5	4	20BC011A0AYNANCO	0
14	16.5	22	10	7.5	20BD014A0AYNANCO	15	17.2	23.1	7.5	5.5	20BC015A0AYNANCO	1
22	24.2	33	15	10	20BD022A0AYNANCO	22	24.2	33	11	7.5	20BC022A0AYNANCO	1
27	33	44	20	15	20BD027A0AYNANCO	30	33	45	15	11	20BC030A0AYNANCO	2
34	40.5	54	25	20	20BD034A0AYNANCO	37	45	60	18.5	15	20BC037A0AYNANCO	2
40	51	68	30	25	20BD040A0AYNANCO	43	56	74	22	18.5	20BC043A0AYNANCO	3
52	60	80	40	30	20BD052A0AYNANCO	56	64	86	30	22	20BC056A0AYNANCO	3
65	78	104	50	40	20BD065A0AYNANCO	72	84	112	37	30	20BC072A0AYNANCO	3
77 (65)‡	85 (98)	116 (130)	60	50	20BD077A0ANNANCO	85 (72)	94 (108)	128 (144)	45	37	20BC085A0ANNANCO	4 ♣
96 (77)‡	106 (116)	144 (154)	75	60	20BD096A0ANNANCO	105 (85)	116 (128)	158 (170)	55	45	20BC105A0ANNANCO	5 ♣
125 (96)‡	138 (144)	163 (168)	100	75	20BD125A0ANNANCO	125 (96)	138 (144)	163 (168)	55	45	20BC125A0ANNANCO	5 ♣
—	—	—	—	—	—	140 (105)	154 (157)	190 (190)	75	55	20BC140A0ANNANCO	5 ♣
156 (125)‡	172 (188)	233 (250)	125	100	20BD156A0ANNANCO	170 (140)	187 (210)	255 (280)	90	75	20BC170A0ANNANCO	6 ♣
180 (156)‡	198 (234)	270 (312)	150	125	20BD180A0ANNANCO	205 (170)	220 (255)	289 (313)	110	90	20BC205A0ANNANCO	6 ♣
248 (180)‡	273 (270)	372 (360)	200	150	20BD248A0ANNANCO	260 (205)	286 (308)	390 (410)	132	110	20BC260A0ANNANCO	6 ♣
292 (263)‡	322 (395)	438 (526)	250	200	20BD292A0ANNANCO	292 (263)	322 (395)	438 (526)	160	150	20BC292A0ANNANCO	7
325 (325)‡	358 (488)	488 (650)	250	250	20BD325A0ANNANCO	325 (325)	358 (488)	488 (650)	180	180	20BC325A0ANNANCO	7
365 (325)‡	402 (488)	548 (650)	300	250	20BD365A0ANNANCO	365 (325)	402 (488)	548 (650)	200	180	20BC365A0ANNANCO	8
415 (365)‡	457 (548)	623 (730)	350	300	20BD415A0ANNANCO	415 (365)	457 (548)	623 (730)	240	200	20BC415A0ANNANCO	8
481 (415)‡	530 (623)	722 (830)	400	350	20BD481A0ANNANCO	481 (415)	530 (623)	722 (830)	280	240	20BC481A0ANNANCO	8
535 (481)‡	589 (722)	803 (962)	450	400	20BD535A0ANNANCO	535 (481)	589 (722)	803 (962)	300	280	20BC535A0ANNANCO	8
600 (535)‡	660 (803)	900 (1070)	500	450	20BD600A0ANNANCO	600 (535)	660 (803)	900 (1070)	350	300	20BC600A0ANNANCO	8
730 (600)‡	803 (900)	1095 (1200)	600	500	20BD730A0ANNANCO	730 (600)	803 (900)	1095 (1200)	400	350	20BC730A0ANNANCO	9
875 (700)‡	963 (1050)	1313 (1400)	700	600	20BD875A0ANNANCO	875 (700)	963 (1050)	1313 (1400)	500	400	20BC875A0ANNANCO	10

‡ These drives have dual current ratings; one for normal duty applications and one for heavy duty applications (in parentheses). The drive may be operated at either rating.

♣ Also available with internal Brake IGBT (20BxxxxA0AYNANCO).

## Wall Mount - IP20, NEMA/UL Type 1 (continued)

## 500...690V AC, Three-Phase Drives

500...600V AC Input						690V AC Input						
Output Amps			Normal Duty Hp	Heavy Duty Hp	Cat. No.	Output Amps			Normal Duty kW	Heavy Duty kW	Cat. No.	Frame Size
Cont.	1 Min.	3 Sec.				Cont.	1 Min.	3 Sec.				
1.7	2	2.6	1	0.5	20BE1P7A0AYNANCO	—	—	—	—	—	—	0
2.7	3.6	4.8	2	1	20BE2P7A0AYNANCO	—	—	—	—	—	—	0
3.9	4.3	5.9	3	2	20BE3P9A0AYNANCO	—	—	—	—	—	—	0
6.1	6.7	9.2	5	3	20BE6P1A0AYNANCO	—	—	—	—	—	—	0
9	9.9	13.5	7.5	5	20BE9P0A0AYNANCO	—	—	—	—	—	—	0
11	13.5	18	10	7.5	20BE011A0AYNANCO	—	—	—	—	—	—	1
17	18.7	25.5	15	10	20BE017A0AYNANCO	—	—	—	—	—	—	1
22	25.5	34	20	15	20BE022A0AYNANCO	—	—	—	—	—	—	2
27	33	44	25	20	20BE027A0AYNANCO	—	—	—	—	—	—	2
32	40.5	54	30	25	20BE032A0AYNANCO	—	—	—	—	—	—	3
41	48	64	40	30	20BE041A0AYNANCO	—	—	—	—	—	—	3
52	61.5	82	50	40	20BE052A0AYNANCO	52 (46)	57 (69)	78 (92)	45	37.5	20BF052A0ANNANCO	3 S
62	78	104	60	50	20BE062A0ANNANCO	60 (52)	66 (78)	90 (104)	55	45	20BF060A0ANNANCO	4 S ♣
77 (63) ‡	85 (94)	116 (126)	75	60	20BE077A0ANNANCO	82 (60)	90 (90)	123 (120)	75	55	20BF082A0ANNANCO	5 ♣
99 (77) ‡	109 (116)	126 (138)	100	75	20BE099A0ANNANCO	98 (82)	108 (123)	127 (140)	90	75	20BF098A0ANNANCO	5 ♣
125 (99) ‡	138 (149)	188 (198)	125	100	20BE125A0ANNANCO	119 (98)	131 (147)	179 (196)	110	90	20BF119A0ANNANCO	6 ♣
144 (125) ‡	158 (188)	216 (250)	150	125	20BE144A0ANNANCO	142 (119)	156 (179)	213 (238)	132	110	20BF142A0ANNANCO	6 ♣

‡ These drives have dual current ratings; one for normal duty applications and one for heavy duty applications (in parentheses). The drive may be operated at either rating.

§ 690V AC input drives are Frame 5.

♣ Also available with internal Brake IGBT (20BxxxxA0AYNANCO).

## Open/Flange Mount

Front = IP00, NEMA/UL Type Open, Back/Heatsink = IP54, NEMA 12

## 380...480V AC, Three-Phase Drives

480V AC Input						400V AC Input						
Output Amps ‡			Normal Duty Hp	Heavy Duty Hp	Cat. No.	Output Amps ‡			Normal Duty kW	Heavy Duty kW	Cat. No.	Frame Size
Cont.	1 Min.	3 Sec.				Cont.	1 Min.	3 Sec.				
96 (77)	106 (116)	144 (154)	75	60	20BD096F0ANNANCO	105 (85)	116 (128)	158 (170)	55	45	20BC105F0ANNANCO	5 ♣
125 (96)	138 (144)	163 (168)	100	75	20BD125F0ANNANCO	125 (96)	138 (144)	163 (168)	55	45	20BC125F0ANNANCO	5 ♣
—	—	—	—	—	—	140 (105)	154 (157)	190 (190)	75	55	20BC140F0ANNANCO	5 ♣
156 (125)	172 (188)	233 (250)	125	100	20BD156F0ANNANCO	170 (140)	187 (210)	255 (280)	90	75	20BC170F0ANNANCO	6 ♣
180 (156)	198 (234)	270 (312)	150	125	20BD180F0ANNANCO	205 (170)	220 (255)	289 (313)	110	90	20BC205F0ANNANCO	6 ♣
248 (180)	273 (270)	372 (360)	200	150	20BD248F0ANNANCO	260 (205)	286 (308)	390 (410)	132	110	20BC260F0ANNANCO	6 ♣
292 (263)	322 (395)	438 (526)	250	200	20BD292N0ANNNNCO	292 (263)	322 (395)	438 (526)	160	150	20BC292N0ANNNNCO	7
325 (325)	358 (488)	488 (650)	250	250	20BD325N0ANNNNCO	325 (325)	358 (488)	488 (650)	180	180	20BC325N0ANNNNCO	7
365 (325)	402 (488)	548 (650)	300	250	20BD365N0ANNNNCO	365 (325)	402 (488)	548 (650)	200	180	20BC365N0ANNNNCO	8
415 (365)	457 (548)	623 (730)	350	300	20BD415N0ANNNNCO	415 (365)	457 (548)	623 (730)	240	200	20BC415N0ANNNNCO	8
481 (415)	530 (623)	722 (830)	400	350	20BD481N0ANNNNCO	481 (415)	530 (623)	722 (830)	280	240	20BC481N0ANNNNCO	8
535 (481)	589 (722)	803 (962)	450	400	20BD535N0ANNNNCO	535 (481)	589 (722)	803 (962)	300	280	20BC535N0ANNNNCO	8
600 (535)	660 (803)	900 (1070)	500	450	20BD600N0ANNNNCO	600 (535)	660 (803)	900 (1070)	350	300	20BC600N0ANNNNCO	8
730 (600)	803 (900)	1095 (1200)	600	500	20BD730N0ANNNNCO	730 (600)	803 (900)	1095 (1200)	400	350	20BC730N0ANNNNCO	9
875 (700)	963 (1050)	1313 (1400)	700	600	20BD875N0ANNNNCO	875 (700)	963 (1050)	1313 (1400)	500	400	20BC875N0ANNNNCO	10

‡ These drives have dual current ratings; one for normal duty applications and one for heavy duty applications (in parentheses). The drive may be operated at either rating.

♣ Also available with internal Brake IGBT (20BxxxxA0AYNANCO).

Roll-In

Front = IP00, NEMA/UL Type Open, Back/Heatsink = IP54, NEMA 12

380...480V AC, Three-Phase Drives

480V AC Input						400V AC Input						
Output Amps ‡			Normal Duty Hp	Heavy Duty Hp	Cat. No.	Output Amps ‡			Normal Duty kW	Heavy Duty kW	Cat. No.	Frame Size
Cont.	1 Min.	3 Sec.				Cont.	1 Min.	3 Sec.				
365 (325)	402 (488)	548 (650)	300	250	20BD365U0ANNNNCO	365 (325)	402 (488)	548 (650)	200	180	20BC365U0ANNNNCO	8
415 (365)	457 (548)	623 (730)	350	300	20BD415U0ANNNNCO	415 (365)	457 (548)	623 (730)	240	200	20BC415U0ANNNNCO	8
481 (415)	530 (623)	722 (830)	400	350	20BD481U0ANNNNCO	481 (415)	530 (623)	722 (830)	280	240	20BC481U0ANNNNCO	8
535 (481)	589 (722)	803 (962)	450	400	20BD535U0ANNNNCO	535 (481)	589 (722)	803 (962)	300	280	20BC535U0ANNNNCO	8
600 (535)	660 (803)	900 (1070)	500	450	20BD600U0ANNNNCO	600 (535)	660 (803)	900 (1070)	350	300	20BC600U0ANNNNCO	8
730 (600)	803 (900)	1095 (1200)	600	500	20BD730U0ANNNNCO	730 (600)	803 (900)	1095 (1200)	400	350	20BC730U0ANNNNCO	9

‡ These drives have dual current ratings; one for normal duty applications and one for heavy duty applications (in parentheses). The drive may be operated at either rating.

Stand-Alone/Wall Mount - IP54, NEMA 12

380...480V AC, Three-Phase Drives

480V AC Input						400V AC Input						
Output Amps ‡			Normal Duty Hp	Heavy Duty Hp	Cat. No.	Output Amps ‡			Normal Duty kW	Heavy Duty kW	Cat. No.	Frame Size
Cont.	1 Min.	3 Sec.				Cont.	1 Min.	3 Sec.				
96 (77)	106 (116)	144 (154)	75	60	20BD096G0ANNANCO	105 (85)	116 (128)	158 (170)	55	45	20BC105G0ANNANCO	5 ♣
125 (96)	138 (144)	163 (168)	100	75	20BD125G0ANNANCO	125 (96)	138 (144)	163 (168)	55	45	20BC125G0ANNANCO	5 ♣
-	-	-	-	-	-	140 (105)	154 (157)	190 (190)	75	55	20BC140G0ANNANCO	5 ♣
156 (125)	172 (188)	233 (250)	125	100	20BD156G0ANNANCO	170 (140)	187 (210)	255 (280)	90	75	20BC170G0ANNANCO	6 ♣
180 (156)	198 (234)	270 (312)	150	125	20BD180G0ANNANCO	205 (170)	220 (255)	289 (313)	110	90	20BC205G0ANNANCO	6 ♣
248 (180)	273 (270)	372 (360)	200	150	20BD248G0ANNANCO	260 (205)	286 (308)	390 (410)	132	110	20BC260G0ANNANCO	6 ♣

‡ These drives have dual current ratings; one for normal duty applications and one for heavy duty applications (in parentheses). The drive may be operated at either rating.

♣ Also available with internal Brake IGBT (20BxxxxA0AYNANCO).

## Approximate Dimensions and Weights

Dimensions are in mm (in.) - weights are in kg (lb)

### IP20, NEMA/UL Type 1

Frame	H	W	D	Weight★
0	336.0 (13.23)	110.0 (4.33)	200.0 (7.87)	5.22 (11.5)
1	336.0 (13.23)	135.0 (5.31)	200.0 (7.87)	7.03 (15.5)
2	342.5 (13.48)	222.0 (8.74)	200.0 (7.87)	12.52 (27.6)
3	517.5 (20.37)	222.0 (8.74)	200.0 (7.87)	18.55 (40.9)
4	758.8 (29.87)	220.0 (8.66)	201.7 (7.94)	24.49 (54.0)
5	644.5 (25.37)†	308.9 (12.16)	275.4 (10.84)	37.19 (82.0)
6	850.0 (33.46)	403.9 (15.90)	275.5 (10.85)	71.44 (157.5)♣
7	1498.6 (59.00)	514.4 (20.25)	406.9 (16.02)	170.00 (375.0)
8	2373.9 (93.46)	757.7 (29.83)	889.0 (35.00)§	509.00 (1122.0)
9	2373.9 (93.46)	757.7 (29.83)	1016.0 (40.00)	526.00 (1159.0)
10 (AC Input)	2373.9 (93.46)	1267.7 (49.91)	889.0 (35.00)	867.00 (1912.0)
10 (DC Input)	2373.9 (93.46)	757.7 (29.83)	889.0 (35.00)	468.00 (1032.0)

★ Weights include HIM and I/O.

† When using the supplied junction box (100 Hp drives only), add an additional 45.1 mm (1.78 in.) to this dimension.

§ Depth for 20Bx535, 600 is 1016.0 (40.00).

♣ Add 13.60 kg (30.0 lbs.) for the following drives; 20BB260, 20BC260 and 20BD248.

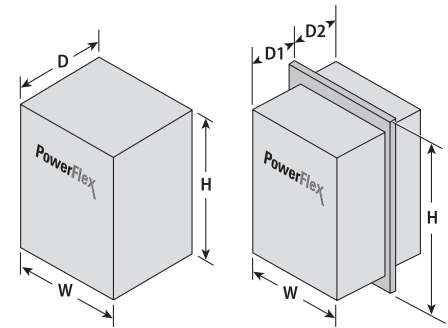

### Open/Flange Mount (Front = IP00, NEMA/UL Type Open, Back/Heatsink = IP54, NEMA 12)

Frame	H	W	D1	D2	Weight
5♣	1061.0 (41.77)	500.0 (19.69)	303.6 (11.95)	97.0 (3.82)	61.69 (136.0)
6♣	1100.0 (43.30)	584.0 (23.00)	294.7 (11.60)	131.6 (5.20)	99.79 (220.0)
7	1498.6 (59.00)	514.4 (20.25)	218.2 (8.59)	134.6 (5.30)	146.96 (324.0)
8	2275.8 (89.60)	757.7 (29.83)	345.4 (13.60)	254.0 (10.00)△	384.19 (847.0)
9	2275.8 (89.60)	757.7 (29.83)	400.8 (15.78)	381.0 (15.00)	400.98 (884.0)
10 (AC Input)	2275.8 (89.60)	1267.7 (49.91)	338.6 (13.30)	252.7 (9.95)	531.61 (1172.0)
10 (DC Input)	2275.8 (89.60)	757.7 (29.83)	338.6 (13.30)	252.7 (9.95)	304.81 (672.0)

♣ 400...690V drives only.

△ Depth for 20Bx535, 600 is 381.0 (15.00).



# PowerFlex 700H AC Drive

The PowerFlex 700H drive is ideal for high power applications requiring speed control performance. This drive provides excellent torque at low speeds for demanding speed control applications and has configurable control modes for a wide variety of applications. The PowerFlex 700H also has an ATEX certified option for drives that operate in potentially explosive environments.

## PowerFlex 700H at a glance

### Ratings

380...480V:	132...1200 kW / 200...1900 Hp / 261...2150 A
500...600V:	150...2400 Hp / 170...2250 A
690V:	160...2300 kW / 170...2250 A

### Motor Control

- V/Hz Control
- Sensorless Vector Control

### Enclosures

IP21, NEMA Type 1

### Safety

DriveGuard Safe Torque-Off / EN954-1 Cat. 3

### Certifications

- ATEX Certified with Safe Torque-Off
- C-Tick
- c-UL, UL
- CE - with Rittal Enclosure
- IEC (Designed to Meet) - with Rittal Enclosure
- TÜV FS ISO/EN13849-1 (EN954-1) with Safe Torque-Off option

### Options

See pages 116...137

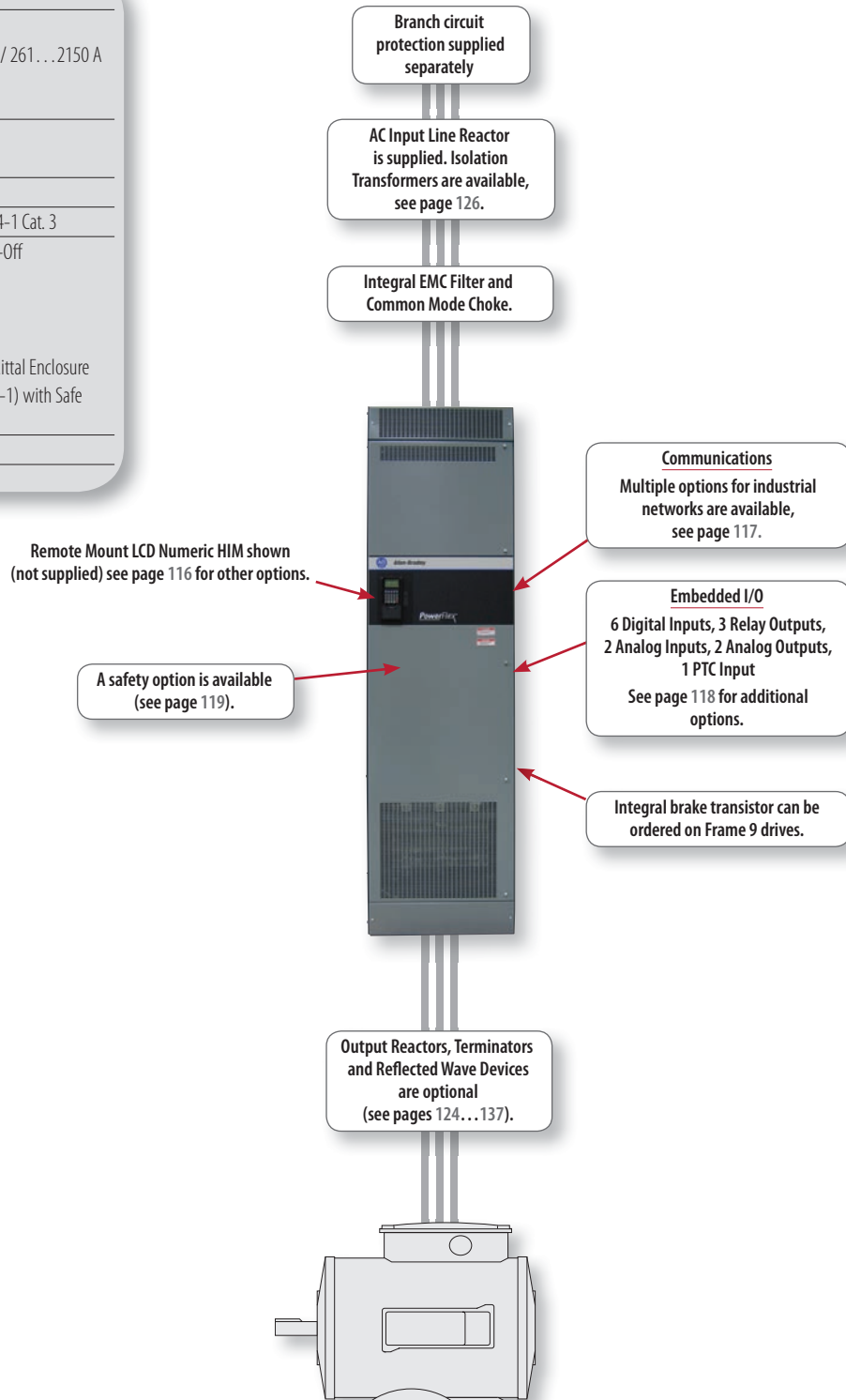

## Additional Information

PowerFlex 700H Technical Data, publication 20C-TD001  
 PowerFlex 700H Installation Manual, publication PFLEX-IN006  
 PowerFlex 700H Programming Manual, publication 20C-PM001

## Catalog Number Explanation

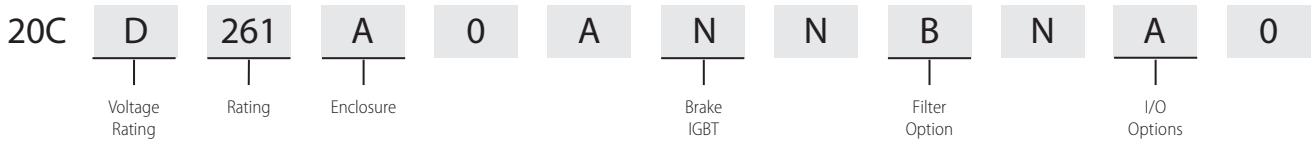

## Product Selection

### IP21, NEMA Type 1

#### 380...480V AC, Three-Phase Drives with 24V DC I/O

480V AC Input					400V AC Input							
Output Amps ★			Normal Duty Hp	Heavy Duty Hp	Cat. No. ♣	Output Amps ★			Normal Duty kW	Heavy Duty kW	Cat. No. ♣	Frame Size
Cont.	1 Min.	2 Sec. ‡				Cont.	1 Min.	2 Sec. ‡				
261 (205)	287 (308)	410 (410)	200	150	20CD261A0ANNBNAO	261 (205)	287 (308)	410 (410)	132	110	20CC261A0ANNBNAO	9
300 (245)	330 (368)	450 (490)	250	200	20CD300A0ANNBNAO	300 (245)	330 (368)	450 (490)	160	132	20CC300A0ANNBNAO	9
385 (300)	424 (450)	600 (600)	300	250	20CD385A0ANNBNAO	385 (300)	424 (450)	600 (600)	200	160	20CC385A0ANNBNAO	10
460 (385)	506 (578)	770 (770)	350	300	20CD460A0ANNBNAO	460 (385)	506 (578)	770 (770)	250	200	20CC460A0ANNBNAO	10
500 (420)	550 (630)	750 (840)	450	350	20CD500A0ANNBNAO	500 (420)	550 (630)	750 (840)	250	250	20CC500A0ANNBNAO	10
590 (520)	649 (780)	956 (956)	500	450	20CD590A0ANNBNAO	590 (520)	649 (780)	956 (956)	315	250	20CC590A0ANNBNAO	11
650 (590)	715 (885)	1062 (1062)	500	500	20CD650A0ANNBNAO	650 (590)	715 (885)	1062 (1062)	355	315	20CC650A0ANNBNAO	11
730 (650)	803 (975)	1095 (1170)	600	500	20CD730A0ANNBNAO	730 (650)	803 (975)	1095 (1170)	400	355	20CC730A0ANNBNAO	11
820 (730)	902 (1095)	1230 (1314)	700	600	20CD820A0ANNBNAO	820 (730)	902 (1095)	1230 (1314)	450	400	20CC820A0ANNBNAO	12
920 (820)	1012 (1230)	1380 (1476)	800	700	20CD920A0ANNBNAO	920 (820)	1012 (1230)	1380 (1476)	500	450	20CC920A0ANNBNAO	12
1030 (920)	1133 (1370)	1555 (1600)	900	800	20CD1K0A0ANNBNAO	1030 (920)	1133 (1370)	1555 (1600)	560	500	20CC1K0A0ANNBNAO	12
1150 (1030)	1265 (1545)	1620 (1620)	1000	900	20CD1K1A0ANNBNAO	1150 (1030)	1265 (1545)	1620 (1620)	630	560	20CC1K1A0ANNBNAO	13
1300 (1150)	1430 (1725)	2079 (2079)	1200	1000	20CD1K3A0ANNBNAO	1300 (1150)	1430 (1725)	2079 (2079)	710	630	20CC1K3A0ANNBNAO	13
1450 (1200)	1595 (1800)	2175 (2400)	1250	1000	20CD1K4A0ANNBNAO	1450 (1200)	1595 (1800)	2175 (2400)	800	710	20CC1K4A0ANNBNAO	13
1770 (1600)	1947 (2400)	2655 (2880)	1500	1400	20CD1K7A0ANNENAO	1770 (1600)	1947 (2400)	2655 (2880)	1000	900	20CC1K7A0ANNENAO	14
2150 (1940)	2365 (2910)	3225 (3492)	1900	1700	20CD2K1A0ANNENAO	2150 (1940)	2365 (2910)	3225 (3492)	1200	1100	20CC2K1A0ANNENAO	14

★ These drives have dual current ratings; normal duty applications and heavy duty applications (in parentheses). The drive may be operated at either rating.

‡ The 2 sec. output current is only available at initial start or drive operating at light load.

♣ Frames 10 and up include a Rittal enclosure.

IP21, NEMA Type 1 (continued)

600...690V AC, Three-Phase Drives with 24V DC I/O

600V AC Input						690V AC Input						
Output Amps ★			Normal Duty Hp	Heavy Duty Hp	Cat. No. ♣	Output Amps ★			Normal Duty kW	Heavy Duty kW	Cat. No. ♣	Frame Size
Cont.	1 Min.	2 Sec. ‡				Cont.	1 Min.	2 Sec. ‡				
170 (144)	187 (216)	245 (245)	150	150	20CE170A0ANNBNAO	170 (144)	187 (216)	245 (245)	160	132	20CF170A0ANNBNAO	9
208 (170)	230 (250)	289 (289)	200	150	20CE208A0ANNBNAO	208 (170)	230 (250)	289 (289)	200	160	20CF208A0ANNBNAO	9
261 (208)	287 (312)	375 (375)	250	200	20CE261A0ANNBNAO	261 (208)	287 (312)	375 (375)	250	200	20CF261A0ANNBNAO	10
325 (261)	358 (392)	470 (470)	350	250	20CE325A0ANNBNAO	325 (261)	358 (392)	470 (470)	315	250	20CF325A0ANNBNAO	10
385 (325)	424 (488)	585 (585)	400	350	20CE385A0ANNBNAO	385 (325)	424 (488)	585 (585)	355	315	20CF385A0ANNBNAO	10
416 (325)	458 (488)	585 (585)	450	350	20CE416A0ANNBNAO	416 (325)	458 (488)	585 (585)	400	315	20CF416A0ANNBNAO	10
460 (385)	506 (578)	693 (693)	500	400	20CE460A0ANNBNAO	460 (385)	506 (578)	693 (693)	450	355	20CF460A0ANNBNAO	11
502 (460)	552 (690)	828 (828)	500	500	20CE502A0ANNBNAO	502 (460)	552 (690)	828 (828)	500	450	20CF502A0ANNBNAO	11
590 (502)	649 (753)	885 (904)	600	500	20CE590A0ANNBNAO	590 (502)	649 (753)	885 (904)	560	500	20CF590A0ANNBNAO	11
650 (590)	715 (885)	1062 (1062)	700	650	20CE650A0ANNBNAO	650 (590)	715 (885)	1062 (1062)	630	560	20CF650A0ANNBNAO	12
750 (650)	825 (975)	1170 (1170)	800	700	20CE750A0ANNBNAO	750 (650)	825 (975)	1170 (1170)	710	630	20CF750A0ANNBNAO	12
820 (750)	902 (975)	1170 (1170)	900	700	20CE820A0ANNBNAO	820 (750)	902 (975)	1170 (1170)	800	630	20CF820A0ANNBNAO	12
920 (820)	1012 (1230)	1380 (1410)	1000	900	20CE920A0ANNBNAO	920 (820)	1012 (1230)	1380 (1410)	900	800	20CF920A0ANNBNAO	13
1030 (920)	1133 (1380)	1545 (1755)	1100	1000	20CE1K0A0ANNBNAO	1030 (920)	1133 (1380)	1545 (1755)	1000	900	20CF1K0A0ANNBNAO	13
1180 (1030)	1298 (1463)	1755 (1755)	1300	1100	20CE1K1A0ANNBNAO	1180 (1030)	1298 (1463)	1755 (1755)	1100	1000	20CF1K1A0ANNBNAO	13
1500 (1300)	1650 (1950)	2250 (2340)	1600	1400	20CE1K5A0ANNENAO	1500 (1300)	1650 (1950)	2250 (2340)	1500	1300	20CF1K5A0ANNENAO	14
1900 (1500)	2090 (2250)	2700 (2700)	2000	1600	20CE1K9A0ANNENAO	1900 (1500)	2090 (2250)	2700 (2700)	1900	1500	20CF1K9A0ANNENAO	14
2250 (1900)	2475 (2782)	3335 (3335)	2400	2000	20CE2K2A0ANNENAO	2250 (1900)	2475 (2782)	3335 (3335)	2300	1900	20CF2K2A0ANNENAO	14

★ These drives have dual current ratings; normal duty applications and heavy duty applications (in parentheses). The drive may be operated at either rating.

‡ The 2 sec. output current is only available at initial start or drive operating at light load.

♣ Frames 10 and up include a Rittal enclosure.

IP20, NEMA Type 1, MCC

380...480V AC, Three-Phase Drives with 24V DC I/O

480V AC Input						400V AC Input						
Output Amps ★			Normal Duty Hp	Heavy Duty Hp	Cat. No.	Output Amps ★			Normal Duty kW	Heavy Duty kW	Cat. No.	Frame Size
Cont.	1 Min.	2 Sec. ‡				Cont.	1 Min.	2 Sec. ‡				
385 (300)	424 (450)	600 (600)	300	250	20CD385B0ANNBNAO	385 (300)	424 (450)	600 (600)	200	160	20CD385B0ANNBNAO	10
460 (385)	506 (578)	770 (770)	350	300	20CD460B0ANNBNAO	460 (385)	506 (578)	770 (770)	250	200	20CD460B0ANNBNAO	10
500 (420)	550 (630)	750 (840)	450	350	20CD500B0ANNBNAO	500 (420)	550 (630)	750 (840)	250	250	20CD500B0ANNBNAO	10
590 (520)	649 (780)	956 (956)	500	450	20CD590B0ANNBNAO	590 (520)	649 (780)	956 (956)	315	250	20CD590B0ANNBNAO	11
650 (590)	715 (885)	1062 (1062)	500	500	20CD650B0ANNBNAO	650 (590)	715 (885)	1062 (1062)	355	315	20CD650B0ANNBNAO	11
730 (650)	803 (975)	1095 (1170)	600	500	20CD730B0ANNBNAO	730 (650)	803 (975)	1095 (1170)	400	355	20CD730B0ANNBNAO	11
820 (730)	902 (1095)	1230 (1314)	700	600	20CD820B0ANNBNAO	820 (730)	902 (1095)	1230 (1314)	450	400	20CD820B0ANNBNAO	12
920 (820)	1012 (1230)	1380 (1476)	800	700	20CD920B0ANNBNAO	920 (820)	1012 (1230)	1380 (1476)	500	450	20CD920B0ANNBNAO	12
1030 (920)	1133 (1370)	1555 (1600)	900	800	20CD1K0B0ANNBNAO	1030 (920)	1133 (1370)	1555 (1600)	560	500	20CD1K0B0ANNBNAO	12

★ These drives have dual current ratings; normal duty applications and heavy duty applications (in parentheses). The drive may be operated at either rating.

‡ The 2 sec. output current is only available at initial start or drive operating at light load.

## IP20, NEMA Type 1, MCC (continued)

## 600V AC, Three-Phase Drives with 24V DC I/O

600V AC Input						
Output Amps ★			Normal Duty Hp	Heavy Duty Hp	Cat. No.	Frame Size
Cont.	1 Min.	2 Sec. ‡				
261 (208)	287 (312)	375 (375)	250	200	20CE261B0ANNBNAO	10
325 (261)	358 (392)	470 (470)	350	250	20CE325B0ANNBNAO	10
385 (325)	424 (488)	585 (585)	400	350	20CE385B0ANNBNAO	10
416 (325)	458 (488)	585 (585)	450	350	20CE416B0ANNBNAO	10
460 (385)	506 (578)	693 (693)	500	400	20CE460B0ANNBNAO	11
502 (460)	552 (690)	828 (828)	500	500	20CE502B0ANNBNAO	11
590 (502)	649 (753)	885 (904)	600	500	20CE590B0ANNBNAO	11
650 (590)	715 (885)	1062 (1062)	700	650	20CE650B0ANNBNAO	12
750 (650)	825 (975)	1170 (1170)	800	700	20CE750B0ANNBNAO	12
820 (750)	902 (975)	1170 (1170)	900	700	20CE820B0ANNBNAO	12

★ These drives have dual current ratings; normal duty applications and heavy duty applications (in parentheses). The drive may be operated at either rating.

‡ The 2 sec. output current is only available at initial start or drive operating at light load.

## IP54, NEMA Type 12, Rittal

## 380...480V AC, Three-Phase Drives with 24V DC I/O

480V AC Input						400V AC Input						
Output Amps ★			Normal Duty Hp	Heavy Duty Hp	Cat. No.	Output Amps ★			Normal Duty kW	Heavy Duty kW	Cat. No.	Frame Size
Cont.	1 Min.	2 Sec. ‡				Cont.	1 Min.	2 Sec. ‡				
385 (300)	424 (450)	600 (600)	300	250	20CD385H0ANNBNAO	385 (300)	424 (450)	600 (600)	200	160	20CC385H0ANNBNAO	10
460 (385)	506 (578)	770 (770)	350	300	20CD460H0ANNBNAO	460 (385)	506 (578)	770 (770)	250	200	20CC460H0ANNBNAO	10
500 (420)	550 (630)	750 (840)	450	350	20CD500H0ANNBNAO	500 (420)	550 (630)	750 (840)	250	250	20CC500H0ANNBNAO	10
590 (520)	649 (780)	956 (956)	500	450	20CD590H0ANNBNAO	590 (520)	649 (780)	956 (956)	315	250	20CC590H0ANNBNAO	11
650 (590)	715 (885)	1062 (1062)	500	500	20CD650H0ANNBNAO	650 (590)	715 (885)	1062 (1062)	355	315	20CC650H0ANNBNAO	11
730 (650)	803 (975)	1095 (1170)	600	500	20CD730H0ANNBNAO	730 (650)	803 (975)	1095 (1170)	400	355	20CC730H0ANNBNAO	11
820 (730)	902 (1095)	1230 (1314)	700	600	20CD820H0ANNBNAO	820 (730)	902 (1095)	1230 (1314)	450	400	20CC820H0ANNBNAO	12
920 (820)	1012 (1230)	1380 (1476)	800	700	20CD920H0ANNBNAO	920 (820)	1012 (1230)	1380 (1476)	500	450	20CC920H0ANNBNAO	12
1030 (920)	1133 (1370)	1555 (1600)	900	800	20CD1K0H0ANNBNAO	1030 (920)	1133 (1370)	1555 (1600)	560	500	20CC1K0H0ANNBNAO	12
1150 (1030)	1265 (1545)	1620 (1620)	1000	900	20CD1K1H0ANNBNAO	1150 (1030)	1265 (1545)	1620 (1620)	630	560	20CC1K1H0ANNBNAO	13
1300 (1150)	1430 (1725)	2079 (2079)	1200	1000	20CD1K3H0ANNBNAO	1300 (1150)	1430 (1725)	2079 (2079)	710	630	20CC1K3H0ANNBNAO	13
1450 (1200)	1595 (1800)	2175 (2400)	1250	1000	20CD1K4H0ANNBNAO	1450 (1200)	1595 (1800)	2175 (2400)	800	710	20CC1K4H0ANNBNAO	13
1770 (1600)	1947 (2400)	2655 (2880)	1500	1400	20CD1K7H0ANNBNAO	1770 (1600)	1947 (2400)	2655 (2880)	1000	900	20CC1K7H0ANNBNAO	14
2150 (1940)	2365 (2910)	3225 (3492)	1900	1700	20CD2K1H0ANNBNAO	2150 (1940)	2365 (2910)	3225 (3492)	1200	1100	20CC2K1H0ANNBNAO	14

★ These drives have dual current ratings; normal duty applications and heavy duty applications (in parentheses). The drive may be operated at either rating.

‡ The 2 sec. output current is only available at initial start or drive operating at light load.

IP54, NEMA Type 12, Rittal (continued)

600...690V AC, Three-Phase Drives with 24V DC I/O

600V AC Input						690V AC Input						
Output Amps ★			Normal Duty Hp	Heavy Duty Hp	Cat. No.	Output Amps ★			Normal Duty kW	Heavy Duty kW	Cat. No.	Frame Size
Cont.	1 Min.	2 Sec. ‡				Cont.	1 Min.	2 Sec. ‡				
261 (208)	287 (312)	375 (375)	250	200	20CE261HOANNBNAO	261 (208)	287 (312)	375 (375)	250	200	20CF261HOANNBNAO	10
325 (261)	358 (392)	470 (470)	350	250	20CE325HOANNBNAO	325 (261)	358 (392)	470 (470)	315	250	20CF325HOANNBNAO	10
385 (325)	424 (488)	585 (585)	400	350	20CE385HOANNBNAO	385 (325)	424 (488)	585 (585)	355	315	20CF385HOANNBNAO	10
416 (325)	458 (488)	585 (585)	450	350	20CE416HOANNBNAO	416 (325)	458 (488)	585 (585)	400	315	20CF416HOANNBNAO	10
460 (385)	506 (578)	693 (693)	500	400	20CE460HOANNBNAO	460 (385)	506 (578)	693 (693)	450	355	20CF460HOANNBNAO	11
502 (460)	552 (690)	828 (828)	500	500	20CE502HOANNBNAO	502 (460)	552 (690)	828 (828)	500	450	20CF502HOANNBNAO	11
590 (502)	649 (753)	885 (904)	600	500	20CE590HOANNBNAO	590 (502)	649 (753)	885 (904)	560	500	20CF590HOANNBNAO	11
650 (590)	715 (885)	1062 (1062)	700	650	20CE650HOANNBNAO	650 (590)	715 (885)	1062 (1062)	630	560	20CF650HOANNBNAO	12
750 (650)	825 (975)	1170 (1170)	800	700	20CE750HOANNBNAO	750 (650)	825 (975)	1170 (1170)	710	630	20CF750HOANNBNAO	12
820 (750)	902 (975)	1170 (1170)	900	700	20CE820HOANNBNAO	820 (750)	902 (975)	1170 (1170)	800	630	20CF820HOANNBNAO	12
920 (820)	1012 (1230)	1380 (1410)	1000	900	20CE920HOANNBNAO	920 (820)	1012 (1230)	1380 (1410)	900	800	20CF920HOANNBNAO	13
1030 (920)	1133 (1380)	1545 (1755)	1100	1000	20CE1030HOANNBNAO	1030 (920)	1133 (1380)	1545 (1755)	1000	900	20CF1030HOANNBNAO	13
1180 (1030)	1298 (1463)	1755 (1755)	1300	1100	20CE1180HOANNBNAO	1180 (1030)	1298 (1463)	1755 (1755)	1100	1000	20CF1180HOANNBNAO	13
1500 (1300)	1650 (1950)	2250 (2340)	1600	1400	20CE1500HOANNBNAO	1500 (1300)	1650 (1950)	2250 (2340)	1500	1300	20CF1500HOANNBNAO	14
1900 (1500)	2090 (2250)	2700 (2700)	2000	1600	20CE1900HOANNBNAO	1900 (1500)	2090 (2250)	2700 (2700)	1900	1500	20CF1900HOANNBNAO	14
2250 (1900)	2475 (2782)	3335 (3335)	2400	2000	20CE2250HOANNBNAO	2250 (1900)	2475 (2782)	3335 (3335)	2300	1900	20CF2250HOANNBNAO	14

★ These drives have dual current ratings; normal duty applications and heavy duty applications (in parentheses). The drive may be operated at either rating.

‡ The 2 sec. output current is only available at initial start or drive operating at light load.

Approximate Dimensions and Weights

Dimensions are in mm (in.) - weights are in kg (lb)

IP21, NEMA Type 1

Frame	H	W	D	Weight ‡
9	1150.0 (45.28)	480.0 (18.90)	363.3 (14.32)	151.00 (333.0)
10	2275.0 (89.57)	597.0 (23.50)	632.5 (24.90)	432.00 (952.0)
11	2275.0 (89.57)	797.0 (31.38)	621.7 (24.48)	676.00 (1490.0)
12	2275.0 (89.57)	1196.0 (47.09)	632.5 (24.90)	864.00 (1906.0)
13	2275.0 (89.57)	1412.0 (55.59) ★	620.0 (24.41)	1400.00 (3086.0)
14 (1500A)	2275.0 (89.57)	2397.0 (94.37)	620.0 (24.41)	1920.00 (4233.0)
14 (above 1500A)	2275.0 (89.57)	2800.0 (110.24)	620.0 (24.41)	3840.00 (8466.0)
14 (DC Input)	2270.0 (89.37)	1597.0 (62.87)	620.0 (24.41)	1450.00 (3130.0)

★ Width for 400/480V AC (540/650V DC) 1300A and 1450A is 1600.0 (62.99).

‡ Weights are approximate. Refer to the PowerFlex 700H Technical Data, publication 20D-TD002 for detailed weight information.

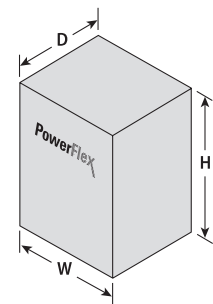

# PowerFlex 700S AC Drive

The PowerFlex 700S offers optimized integration for the most demanding stand-alone and coordinated drive control and drive system applications. The PowerFlex 700S offers a DriveLogix option which combines the powerful performance and flexible control of PowerFlex AC drives with a high-performance Logix engine to produce a highly functional, cost effective drive and control solution.

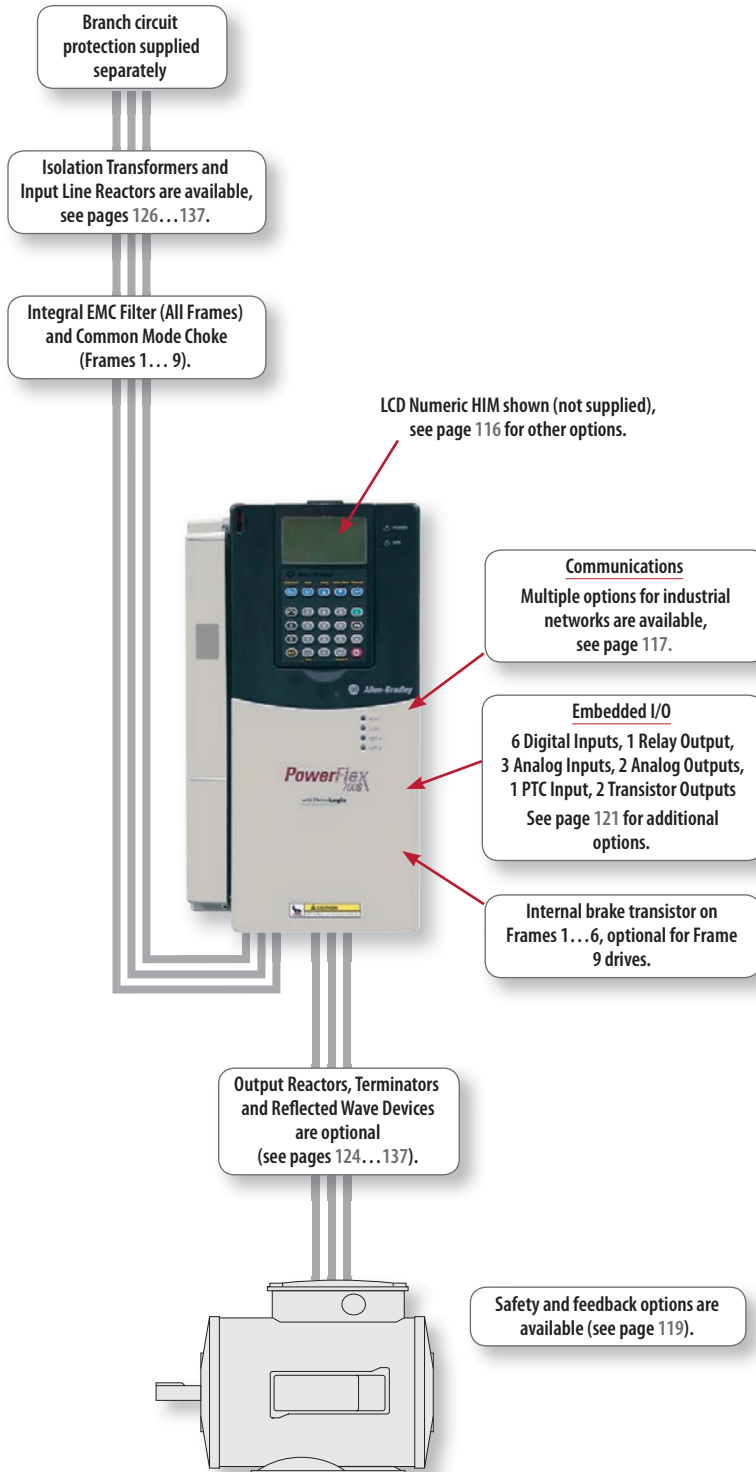

## PowerFlex 700S at a glance

### Ratings

200...240V:	0.75...66 kW / 1...100 Hp / 4.2...260 A
380...480V:	0.75...800 kW / 1...1250 Hp / 2.1...1450 A
500...600V:	1...1600 Hp / 1.7...1500 A
690V:	50...1500 kW / 52...1500 A

### Motor Control

- V/Hz Control
- Vector Control with FORCE Technology (with and without encoder)
- Permanent Magnet Motor Control

### Enclosures

- IP20, NEMA/UL Type 1
- IP21, NEMA/UL Type 1

### Safety

DriveGuard Safe Torque-Off / EN 954-1 Cat. 3

### Additional Features

- Integrated position loop for simple indexing to electronic line shaft applications
- SynchLink for high speed data transfer and synchronization
- Multiple motor feedback options
- DriveLogix

### Certifications

- C-Tick
- c-UL, UL
- CE
- IEC (Designed to Meet)
- RINA (Frames 1...10)
- TÜV FS ISO/EN13849-1 (EN954-1) with Safe Torque-Off option

### Options

See pages 116...137



## Additional Information

PowerFlex 700S Technical Data, publication 20D-TD002  
 PowerFlex 700S Installation Manual Frames 1...6, publication 20D-IN024  
 PowerFlex 700S Installation Manual Frames 9...14, publication PFLEX-IN006  
 PowerFlex 700S Programming Manual, publication 20D-PM001

## Catalog Number Explanation

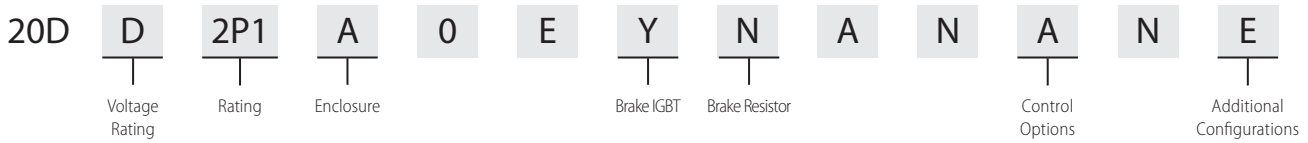

## Product Selection

### IP20, NEMA/UL Type 1

#### 200...240V AC, Three-Phase Drives

240V AC Input						208V AC Input★						Frame Size
Output Amps			Normal Duty Hp	Heavy Duty Hp	Cat. No.	Output Amps			Normal Duty kW	Heavy Duty kW	Cat. No.	
Cont.	1 Min.	3 Sec.				Cont.	1 Min.	3 Sec.				
4.2	4.8	6.4	1	0.75	20DB4P2A0EYNANANE	4.8	5.6	7	0.75	0.37	20DB4P2A0EYNANANE	1
6.8	9	12	2	1.5	20DB6P8A0EYNANANE	7.8	10.4	13.8	1.5	0.75	20DB6P8A0EYNANANE	1
9.6	10.6	14.4	3	2	20DB9P6A0EYNANANE	11	12.1	17	2.2	1.5	20DB9P6A0EYNANANE	1
15.3	16.8	23	5	3	20DB015A0EYNANANE	17.5	19.3	26.3	4	2.2	20DB015A0EYNANANE	1
22	24.2	33	7.5	5	20DB022A0EYNANANE	25.3	27.8	38	5.5	4	20DB022A0EYNANANE	1
28	33	44	10	7.5	20DB028A0EYNANANE	32.2	38	50.6	7.5	5.5	20DB028A0EYNANANE	2
42	46.2	63	15	10	20DB042A0EYNANANE	48.3	53.1	72.5	11	7.5	20DB042A0EYNANANE	3
52	63	80	20	15	20DB052A0EYNANANE	56	64	86	15	11	20DB052A0EYNANANE	3
70	78	105	25	20	20DB070A0ENNANANE	78.2	86	117.3	18.5	15	20DB070A0ENNANANE	4 ♣
80	105	136	30	25	20DB080A0ENNANANE	92	117.3	156.4	22	18.5	20DB080A0ENNANANE	4 ♣
104 (80) ‡	115 (120)	175 (160)	40	30	20DB104A0ENNANANE	120 (92)	132 (138)	175 (175)	30	22	20DB104A0ENNANANE	5 ♣
130 (104) ‡	143 (156)	175 (175)	50	40	20DB130A0ENNANANE	130 (104)	143 (156)	175 (175)	30	30	20DB130A0ENNANANE	5 ♣
154 (130) ‡	169 (195)	231 (260)	60	50	20DB154A0ENNANANE	177 (150)	195 (225)	266 (300)	45	37	20DB154A0ENNANANE	6 ♣
192 (154) ‡	211 (231)	288 (308)	75	60	20DB192A0ENNANANE	221 (177)	243 (266)	308 (308)	55	45	20DB192A0ENNANANE	6 ♣
260 (205) ‡	286 (305)	390 (410)	100	75	20DB260A0ENNANANE	260 (205)	286 (305)	390 (410)	66	55	20DB260A0ENNANANE	6 ♣

★ Drive must be programmed to lower voltage to obtain higher currents shown.  
 ‡ These drives have dual current ratings; one for normal duty applications and one for heavy duty applications (in parentheses). The drive may be operated at either rating.  
 ♣ Also available with internal Brake IGBT (20DxxxxA0EYNANANE).

## IP20, NEMA/UL Type 1 (continued)

## 380...480V AC, Three-Phase Drives

480V AC Input						400V AC Input						Frame Size
Output Amps			Normal Duty Hp	Heavy Duty Hp	Cat. No.	Output Amps			Normal Duty kW	Heavy Duty kW	Cat. No.	
Cont.	1 Min.	3 Sec.				Cont.	1 Min.	3 Sec.				
2.1	2.4	3.2	1	0.75	20DD2P1A0EYNNANANE	2.1	2.4	3.2	0.75	0.55	20DC2P1A0EYNNANANE	1
3.4	4.5	6	2	1.5	20DD3P4A0EYNNANANE	3.5	4.5	6	1.5	0.75	20DC3P5A0EYNNANANE	1
5	5.5	7.5	3	2	20DD5P0A0EYNNANANE	5	5.5	7.5	2.2	1.5	20DC5P0A0EYNNANANE	1
8	8.8	12	5	3	20DD8P0A0EYNNANANE	8.7	9.9	13.2	4	2.2	20DC8P7A0EYNNANANE	1
11	12.1	16.5	7.5	5	20DD011A0EYNNANANE	11.5	13	17.4	5.5	4	20DC011A0EYNNANANE	1
14	16.5	22	10	7.5	20DD014A0EYNNANANE	15.4	17.2	23.1	7.5	5.5	20DC015A0EYNNANANE	1
22	24.2	33	15	10	20DD022A0EYNNANANE	22	24.2	33	11	7.5	20DC022A0EYNNANANE	1
27	33	44	20	15	20DD027A0EYNNANANE	30	33	45	15	11	20DC030A0EYNNANANE	2
34	40.5	54	25	20	20DD034A0EYNNANANE	37	45	60	18.5	15	20DC037A0EYNNANANE	2
40	51	68	30	25	20DD040A0EYNNANANE	43	56	74	22	18.5	20DC043A0EYNNANANE	3
52	60	80	40	30	20DD052A0EYNNANANE	56	64	86	30	22	20DC056A0EYNNANANE	3
65	78	104	50	40	20DD065A0EYNNANANE	72	84	112	37	30	20DC072A0EYNNANANE	3
77 (65) ‡	85 (98)	116 (130)	60	50	20DD077A0ENNNANANE	85 (72)	94 (108)	128 (144)	45	37	20DC085A0ENNNANANE	4 ♣
96 (77) ‡	106 (116)	144 (154)	75	60	20DD096A0ENNNANANE	105 (85)	116 (128)	158 (170)	55	45	20DC105A0ENNNANANE	5 ♣
125 (96) ‡	138 (144)	163 (168)	100	75	20DD125A0ENNNANANE	125 (96)	138 (144)	163 (168)	55	45	20DC125A0ENNNANANE	5 ♣
—	—	—	—	—	—	140 (105)	154 (158)	210 (210)	75	55	20DC140A0ENNNANANE	5 ♣
156 (125) ‡	172 (188)	233 (250)	125	100	20DD156A0ENNNANANE	170 (140)	187 (210)	255 (280)	90	75	20DC170A0ENNNANANE	6 ♣
180 (156) ‡	198 (234)	270 (312)	150	125	20DD180A0ENNNANANE	205 (170)	220 (255)	289 (313)	110	90	20DC205A0ENNNANANE	6 ♣
248 (180) ‡	273 (270)	372 (360)	200	150	20DD248A0ENNNANANE	260 (205)	286 (308)	390 (410)	132	110	20DC260A0ENNNANANE	6 ♣
261 (205) ‡	287 (308)	410 (410)	200	150	20DD261A0ENNNANANE	261 (205)	287 (308)	410 (410)	132	110	20DC261A0ENNNANANE	9
300 (245) ‡	330 (368)	450 (490)	250	200	20DD300A0ENNNANANE	300 (245)	330 (368)	450 (490)	160	130	20DC300A0ENNNANANE	9
385 (300) ‡	424 (450)	600 (600)	300	250	20DD385A0ENNNANANE	385 (300)	424 (450)	600 (600)	200	160	20DC385A0ENNNANANE	10
460 (385) ‡	506 (578)	770 (770)	350	300	20DD460A0ENNNANANE	460 (385)	506 (578)	770 (770)	250	200	20DC460A0ENNNANANE	10
500 (420) ‡	550 (630)	750 (840)	450	350	20DD500A0ENNNANANE	500 (420)	550 (630)	750 (840)	250	250	20DC500A0ENNNANANE	10
590 (520) ‡	649 (780)	956 (956)	500	450	20DD590A0ENNNANANE	590 (520)	649 (780)	956 (956)	315	250	20DC590A0ENNNANANE	11
650 (590) ‡	715 (885)	1062 (1062)	500	500	20DD650A0ENNNANANE	650 (590)	715 (885)	1062 (1062)	355	315	20DC650A0ENNNANANE	11
730 (650) ‡	803 (975)	1095 (1170)	600	500	20DD730A0ENNNANANE	730 (650)	803 (975)	1095 (1170)	400	355	20DC730A0ENNNANANE	11
820 (730) ‡	902 (1095)	1230 (1314)	700	600	20DD820A0ENNNANANE	820 (730)	902 (1095)	1230 (1314)	450	400	20DC820A0ENNNANANE	12
920 (820) ‡	1012 (1230)	1380 (1476)	800	700	20DD920A0ENNNANANE	920 (820)	1012 (1230)	1380 (1476)	500	450	20DC920A0ENNNANANE	12
1030 (920) ‡	1133 (1370)	1555 (1600)	900	800	20DD1K0A0ENNNANANE	1030 (920)	1133 (1370)	1555 (1600)	560	500	20DC1K0A0ENNNANANE	12
1150 (1030) ‡	1265 (1545)	1620 (1620)	1000	900	20DD1K1A0ENNNANANE	1150 (1030)	1265 (1545)	1620 (1620)	630	560	20DC1K1A0ENNNANANE	13
1300 (1150) ‡	1430 (1725)	2079 (2079)	1200	1000	20DD1K3A0ENNNANANE	1300 (1150)	1430 (1725)	2079 (2079)	710	630	20DC1K3A0ENNNANANE	13
1450 (1200) ‡	1595 (1800)	2175 (2400)	1250	1000	20DD1K4A0ENNNANANE	1450 (1200)	1595 (1800)	2175 (2400)	800	710	20DC1K4A0ENNNANANE	13

‡ These drives have dual current ratings; one for normal duty applications and one for heavy duty (in parentheses). The drive may be operated at either rating.

♣ Also available with internal Brake IGBT (20DxxxxA0EYNNANANE).

IP20, NEMA/UL Type 1 (continued)

500...690V AC, Three-Phase Drives

500...600V AC Input $\Delta$						690V AC Input $\Delta$						Frame Size
Output Amps			Normal Duty Hp	Heavy Duty Hp	Cat. No.	Output Amps			Normal Duty kW	Heavy Duty kW	Cat. No.	
Cont.	1 Min.	3 Sec.				Cont.	1 Min.	3 Sec.				
1.7	2	2.6	1	0.5	20DE1P7A0EYNNANANE	—	—	—	—	—	—	1
2.7	3.6	4.8	2	1	20DE2P7A0EYNNANANE	—	—	—	—	—	—	1
3.9	4.3	5.9	3	2	20DE3P9A0EYNNANANE	—	—	—	—	—	—	1
6.1	6.7	9.2	5	3	20DE6P1A0EYNNANANE	—	—	—	—	—	—	1
9	9.9	13.5	7.5	5	20DE9P0A0EYNNANANE	—	—	—	—	—	—	1
11	13.5	18	10	7.5	20DE011A0EYNNANANE	—	—	—	—	—	—	1
17	18.7	25.5	15	10	20DE017A0EYNNANANE	—	—	—	—	—	—	1
22	25.5	34	20	15	20DE022A0EYNNANANE	—	—	—	—	—	—	2
27	33	44	25	20	20DE027A0EYNNANANE	—	—	—	—	—	—	2
32	40.5	54	30	25	20DE032A0EYNNANANE	—	—	—	—	—	—	3
41	48	64	40	30	20DE041A0EYNNANANE	—	—	—	—	—	—	3
52	61.5	82	50	40	20DE052A0EYNNANANE	52	57	78	50	40	20DF052A0ENNANANE	3 $\blacklozenge$
62	78	104	60	50	20DE062A0EYNNANANE	60	66	90	55	45	20DF060A0ENNANANE	4 $\clubsuit$
77 (63) †	85 (94)	116 (126)	75	60	20DE077A0ENNANANE	82 (60)	90 (90)	120 (123)	75	55	20DF082A0ENNANANE	5 $\clubsuit$
99 (77) †	109 (116)	126 (138)	100	75	20DE099A0ENNANANE	98 (82)	108 (123)	127 (140)	90	75	20DF098A0ENNANANE	5 $\clubsuit$
125 (99) †	138 (149)	188 (198)	125	100	20DE125A0ENNANANE	119 (98)	131 (147)	179 (196)	110	90	20DF119A0ENNANANE	6 $\clubsuit$
144 (125) †	158 (188)	216 (250)	150	125	20DE144A0ENNANANE	142 (119)	156 (179)	213 (238)	132	110	20DF142A0ENNANANE	6 $\clubsuit$
170 (144) †	187 (216)	245 (245)	150	150	20DE170A0ENNBANANE	170 (144)	187 (216)	245 (245)	160	132	20DF170A0ENNBANANE	9
208 (170) †	230 (250)	289 (289)	200	150	20DE208A0ENNBANANE	208 (170)	230 (250)	289 (289)	200	160	20DF208A0ENNBANANE	9
261 (208) †	287 (312)	375 (375)	250	200	20DE261A0ENNBANANE	261 (208)	287 (312)	375 (375)	250	200	20DF261A0ENNBANANE	10
325 (261) †	358 (392)	470 (470)	350	250	20DE325A0ENNBANANE	325 (261)	358 (392)	470 (470)	315	250	20DF325A0ENNBANANE	10
385 (325) †	424 (488)	585 (585)	400	350	20DE385A0ENNBANANE	385 (325)	424 (488)	585 (585)	355	315	20DF385A0ENNBANANE	10
416 (325) †	458 (488)	585 (585)	450	350	20DE416A0ENNBANANE	416 (325)	458 (488)	585 (585)	400	315	20DF416A0ENNBANANE	10
460 (385) †	506 (578)	693 (693)	450	400	20DE460A0ENNBANANE	460 (385)	506 (578)	693 (693)	450	355	20DF460A0ENNBANANE	11
502 (460) †	552 (690)	828 (828)	500	450	20DE502A0ENNBANANE	502 (460)	552 (690)	828 (828)	500	450	20DF502A0ENNBANANE	11
590 (502) †	649 (753)	904 (904)	600	500	20DE590A0ENNBANANE	590 (502)	649 (753)	904 (904)	560	500	20DF590A0ENNBANANE	11
650 (590) †	715 (885)	1062 (1062)	700	650	20DE650A0ENNBANANE	650 (590)	715 (885)	1062 (1062)	630	560	20DF650A0ENNBANANE	12
750 (650) †	825 (975)	1170 (1170)	800	700	20DE750A0ENNBANANE	750 (650)	825 (975)	1170 (1170)	710	630	20DF750A0ENNBANANE	12
820 (750) †§	902 (975)	1170 (1170)	900	700	20DE820A0ENNBANANE	820 (750)	902 (975)	1170 (1170)	800	630	20DF820A0ENNBANANE	12
920 (820) †	1012 (1230)	1380 (1410)	1000	900	20DE920A0ENNBANANE	920 (820)	1012 (1230)	1380 (1410)	900	800	20DF920A0ENNBANANE	13
1030 (920) †	1133 (1380)	1545 (1755)	1100	1000	20DE1K0A0ENNBANANE	1030 (920)	1133 (1380)	1545 (1755)	1000	900	20DF1K0A0ENNBANANE	13
1180 (1030) †	1298 (1463)	1755 (1755)	1300	1100	20DE1K1A0ENNBANANE	1180 (1030)	1298 (1463)	1755 (1755)	1100	1000	20DF1K1A0ENNBANANE	13
1500 (1300) †	1650 (1950)	2250 (2340)	1600	1400	20DE1K5A0ENNBANANE	1500 (1300)	1650 (1950)	2250 (2340)	1500	1300	20DF1K5A0ENNBANANE	14

† These drives have dual current ratings; one for normal duty applications and one for heavy duty applications (in parentheses). The drive may be operated at either rating.

§ 600V class drives at 820 amps (ND) such as 20DF820 and 20DE820 are only capable of producing 95% of starting torque under 10 Hz.

$\clubsuit$  Also available with internal Brake IGBT (20DxxxxA0EYNNANANE).

$\Delta$  CE Certification testing has not been performed on 600V class drives Frames 1...4.

$\blacklozenge$  690V drives are Frame 5.

## IP21, NEMA/UL Type 1, MCC

## 380...480V AC, Three-Phase Drives

480V AC Input						400V AC Input						Frame Size
Output Amps ‡			Normal Duty Hp	Heavy Duty Hp	Cat. No.	Output Amps ‡			Normal Duty kW	Heavy Duty kW	Cat. No.	
Cont.	1 Min.	3 Sec.				Cont.	1 Min.	3 Sec.				
385 (300)	424 (450)	600 (600)	300	250	20DD385B0ENNBNANE	385 (300)	424 (450)	600 (600)	200	160	20DC385B0ENNBNANE	10
460 (385)	506 (578)	770 (770)	350	300	20DD460B0ENNBNANE	460 (385)	506 (578)	770 (770)	250	200	20DC460B0ENNBNANE	10
500 (420)	550 (630)	750 (840)	450	350	20DD500B0ENNBNANE	500 (420)	550 (630)	750 (840)	250	250	20DC500B0ENNBNANE	10
590 (520)	649 (780)	956 (956)	500	450	20DD590B0ENNBNANE	590 (520)	649 (780)	956 (956)	315	250	20DC590B0ENNBNANE	11
650 (590)	715 (885)	1062 (1062)	500	500	20DD650B0ENNBNANE	650 (590)	715 (885)	1062 (1062)	355	315	20DC650B0ENNBNANE	11
730 (650)	803 (975)	1095 (1170)	600	500	20DD730B0ENNBNANE	730 (650)	803 (975)	1095 (1170)	400	355	20DC730B0ENNBNANE	11
820 (730)	902 (1095)	1230 (1314)	700	600	20DD820B0ENNBNANE	820 (730)	902 (1095)	1230 (1314)	450	400	20DC820B0ENNBNANE	12
920 (820)	1012 (1230)	1380 (1476)	800	700	20DD920B0ENNBNANE	920 (820)	1012 (1230)	1380 (1476)	500	450	20DC920B0ENNBNANE	12
1030 (920)	1133 (1370)	1555 (1600)	900	800	20DD1K0B0ENNBNANE	1030 (920)	1133 (1370)	1555 (1600)	560	500	20DC1K0B0ENNBNANE	12

‡ These drives have dual current ratings; one for normal duty applications and one for heavy duty (in parentheses). The drive may be operated at either rating.

## 500...600V AC, Three-Phase Drives

600V AC Input							Frame Size
Output Amps ‡			Normal Duty Hp	Heavy Duty Hp	Cat. No.	Frame Size	
Cont.	1 Min.	3 Sec.					
261 (208)	287 (312)	375 (375)	250	200	20DE261B0ENNBNANE	10	
325 (261)	358 (392)	470 (470)	350	250	20DE325B0ENNBNANE	10	
385 (325)	424 (488)	585 (585)	400	350	20DE385B0ENNBNANE	10	
416 (325)	458 (488)	585 (585)	450	350	20DE416B0ENNBNANE	10	
460 (385)	506 (578)	693 (693)	450	400	20DE460B0ENNBNANE	11	
502 (460)	552 (690)	828 (828)	500	450	20DE502B0ENNBNANE	11	
590 (502)	649 (753)	904 (904)	600	500	20DE590B0ENNBNANE	11	
650 (590)	715 (885)	1062 (1062)	700	650	20DE650B0ENNBNANE	12	
750 (650)	825 (975)	1170 (1170)	800	700	20DE750B0ENNBNANE	12	
820 (750) §	902 (975)	1170 (1170)	900	700	20DE820B0ENNBNANE	12	

‡ These drives have dual current ratings; one for normal duty applications and one for heavy duty (in parentheses). The drive may be operated at either rating.

§ 600V class drives at 820 amps (ND) such as 20DF820 and 20DE820 are only capable of producing 95% of starting torque under 10 Hz.

## Approximate Dimensions and Weights

Dimensions are in mm (in.) - weights are in kg (lb)

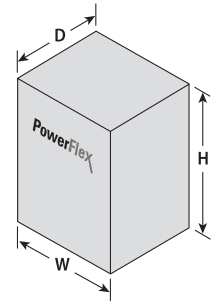

### IP20/21, NEMA/UL Type 1

Frame	H	W	D	Weight ★
1	336.0 (13.23)	166.9 (6.57) §	200.0 (7.87)	7.03 (15.5)
2	342.5 (13.48)	253.9 (9.99) §	200.0 (7.87)	12.52 (27.6)
3	517.5 (20.37)	253.9 (9.99) §	200.0 (7.87)	18.55 (40.9)
4	758.8 (29.87)	251.9 (9.92) §	201.7 (7.94)	24.49 (54.0)
5	644.5 (25.37) ‡	339.9 (13.38) §	275.4 (10.84)	37.19 (82.0)
6	850.0 (33.46)	435.8 (17.16) §	275.5 (10.85)	71.44 (157.5) △
9	1150.0 (45.28)	480.0 (18.90)	363.3 (14.32)	151.00 (333.0)
10	2275.0 (89.57)	597.0 (23.50)	632.5 (24.90)	432.00 (952.0)
11	2275.0 (89.57)	797.0 (31.38)	621.7 (24.48)	676.00 (1490.0)
12	2275.0 (89.57)	1196.1 (47.09)	632.5 (24.90)	864.00 (1906.0)
13	2275.0 (89.57)	1412.0 (55.6) ♣	620.0 (24.41)	1400 (3086)
14 (1500A)	2275.0 (89.57)	2397.0 (94.37)	620.0 (24.41)	1920.00 (4233.0)
14 (above 1500A)	2275.0 (89.57)	2800.0 (110.24)	620.0 (24.41)	1920.00 (4233.0)
14 (DC Input)	2270.0 (89.37)	1597.0 (62.87)	620.0 (24.41)	1220.00 (2690.0)

★ Weights are approximate and include HIM, DriveLogix controller with ControlNet daughter card, Hi-Resolution Encoder Option, and 20-COMM-C ControlNet adapter. Refer to the PowerFlex 700S Technical Data for detailed weight information.

‡ When using the supplied junction box (100 Hp drives only), add an additional 45.1 mm (1.78 in.) to this dimension.

§ Dimension includes expanded cassette.

♣ Width for 400/480V AC (540/650V DC) 1300 and 1450A is 1600.0 (62.99).

△ Add an additional 3.6 kg (8.00 lb) for 200 Hp drives.

# PowerFlex 700L AC Drive

The PowerFlex 700L is available with the PowerFlex 700 or PowerFlex 700S control in a fully regenerative, liquid-cooled power structure. This powerful combination offers great performance and high power capabilities in a small package along with low harmonics.

Available as a panel mount unit or in a cabinet, this liquid cooled drive features regenerative braking which is ideal for precise, high-response speed and position control, continuous holdback, rapid deceleration and stopping of high inertia loads. Instead of wasting energy with resistor braking technology, regenerative braking actually puts the energy back into the system to be used by other equipment.

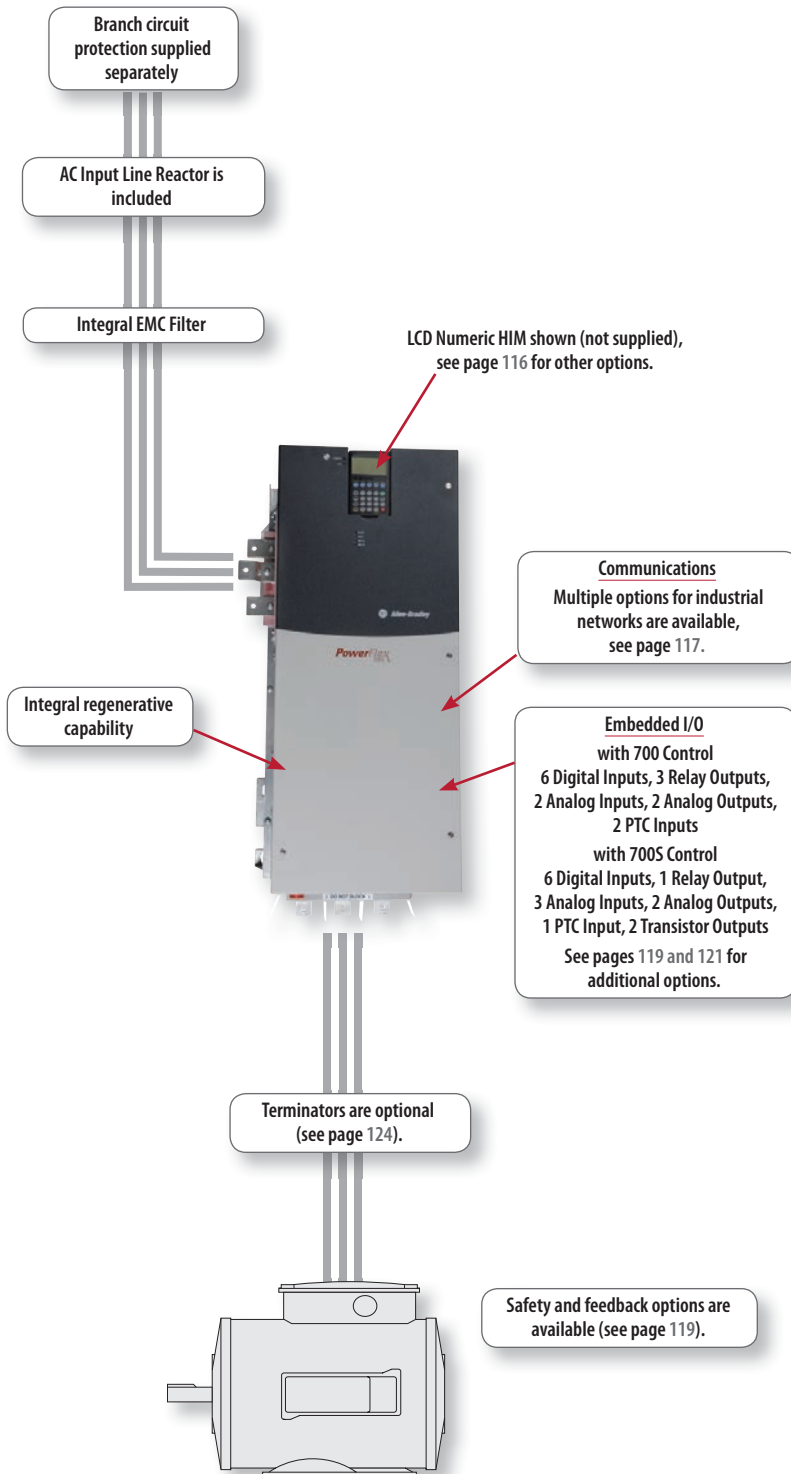

## PowerFlex 700L at a glance

### Ratings

380...480V:	200...860 kW / 268...1150 Hp / 360...1250 A
500...600V:	345...650 kW / 465...870 Hp / 425...800 A
690V:	355...657 kW / 475...881 Hp / 380...705 A

**Motor Control** Select PowerFlex 700 or PowerFlex 700S Control

**Enclosures**

- IP00, NEMA/UL Type Open (Frame 2)
- IP20, NEMA/UL Type 1 (Frames 3A, 3B)

**Safety** DriveGuard Safe Torque-Off / EN 954-1 Cat. 3 with PowerFlex 700S control. ★

**Additional Features** SynchLink and DriveLogix functionality with PowerFlex 700S control. Refer to the PowerFlex 700 or 700S for further information.

**Certifications**

- c-UL-us
- CE
- IEC (Designed to Meet)
- TÜV FS ISO/EN13849-1 (EN954-1) with PowerFlex 700S control

**Options** See pages 116...137

★ On Frame 2 drives, DriveGuard Safe Torque-Off is only available as a factory installed option.





## Cooling Loops

### Liquid to Liquid Heat Exchanger

The liquid to liquid heat exchanger utilizes a heat transfer plate to transfer heat from one liquid to another and requires a stable water supply. This type of cooling loop must be user supplied, it is not available from Rockwell Automation.

### Liquid to Air Heat Exchanger

The liquid to air heat exchanger utilizes radiator technology to transfer heat from a liquid to surrounding air. This is a simple closed loop system—it does not require a water supply from the user. However, this system requires surrounding air 5 to 10 °C below the maximum operating temperature of the drive. This type of cooling loop must be user supplied, it is not available from Rockwell Automation.

### Chiller

The chiller uses refrigerant to transfer heat from a liquid to air. This is a simple closed loop system—it does not require a water supply from the user. A chiller can achieve almost any water temperature required. This type of cooling loop must be user supplied, it is not available from Rockwell Automation.

### Hose Kits

Hose Length m (ft)	Hoses per Kit	Drive Side Coupling Size	Heat Exchanger Side Coupling Size	Used with ...	Hose Kit Cat. No.§
3 (10)	2	0.75 in.	0.75 in.	Frame 2 and user supplied liquid-liquid heat exchanger‡	20L-GH10-B1
9.1 (30)	2	0.75 in.	0.75 in.	Frame 2 and user supplied liquid-liquid heat exchanger‡	20L-GH30-B1
3 (10)	2	1 in.	1 in. with 90° Elbow	Frame 3A and user supplied liquid-liquid heat exchanger‡	20L-GH10-A2
9.1 (30)	2	1 in.	1 in. with 90° Elbow	Frame 3A and user supplied liquid-liquid heat exchanger‡	20L-GH30-A2
3 (10)	2	1 in.	1 in.	Frame 3B and user supplied liquid-liquid heat exchanger‡	20L-GH10-A1
9.1 (30)	2	1 in.	1 in.	Frame 3B and user supplied liquid-liquid heat exchanger‡	20L-GH30-A1

§ Each hose kit contains 2 hoses and the appropriate connectors.

‡ User must verify the coupling size on the heat exchanger.

## Approximate Dimensions and Weights

Dimensions are in mm (in.) - weights are in kg (lb)

### IP20, NEMA/UL Type 1★

Frame	H	W	D	Weight
2	955.7 (37.63)	423.8 (16.68)	566.1 (22.29)	186.00 (410.0)
3A	2078.0 (81.90)	1200.0 (47.20)	600.0 (23.60)	950.00 (2090.0)
3B	2278.0 (89.80)	1600.0 (63.00)	800.0 (31.50)	1361.00 (3000.0)

★ Frames 3A and 3B only. Frame 2 drives are IP00, NEMA/UL Type Open.

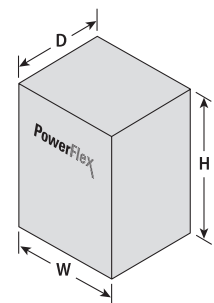

# PowerFlex 753 AC Drive

Designed for general purpose applications, the PowerFlex 753 AC drive offers multiple options and features along with the added benefit of simple integration. The PowerFlex 753 comes standard with built-in I/O making it a cost effective solution ideal for OEMs and system integrators looking to reduce engineering costs, deliver machines to market faster and meet end-user demand for more productive and safer machines.

## PowerFlex 753 at a glance

### Ratings

380...480V:	0.75...250 kW / 1.0...350 Hp / 2.1...456 A
600V:	1.0...300 Hp / 1.7...289 A
690V:	7.5...250 kW / 12...263 A

### Motor Control

- V/Hz Control
- Sensorless Vector Control
- Vector Control with FORCE Technology (with and without encoder)
- Interior Permanent Magnet with and without encoder

### Enclosures

- IP00/IP20, NEMA/UL Type Open
- Flange Mount
- IP54/NEMA/UL Type 12

### Safety

- Safe Torque-Off PLe/SIL3 Cat. 3
- Safe Speed Monitor PLe/SIL3 Cat. 4

### Additional Features

- DeviceLogix
- Predictive Diagnostics
- Adjustable Voltage Control
- Three option slots for I/O, feedback, safety, auxiliary control power, communications
- Indexing
- Pump Jack and Pump Off for oil well applications
- Pjump and Traverse for Fibers application
- Conformal Coating
- DC Link Choke
- Automatic Device Configuration ★

### Certifications

- ABS (Frames 2...7, 400/480V AC)
- ATEX Certified with appropriate options
- C-Tick
- c-UL-us
- CE
- EPRI/SEMI F47
- GOST-R (Frames 2...7, 400/480V AC)
- Lloyd's Register (Frames 2...7, 400/480V AC)
- RINA (Frames 2...7, 400/480V AC)
- RoHS compliant materials
- FS ISO/EN13849-1 (EN954-1) with Safe Torque-Off option

### Options

See pages 116...137

- ★ Requires Dual-port EtherNet/IP Option Module (Cat. No. 20-750-ENETR), firmware V7, Studio 5000 Logix Designer, and Drive Add-On Profiles Version 4.04 or higher.

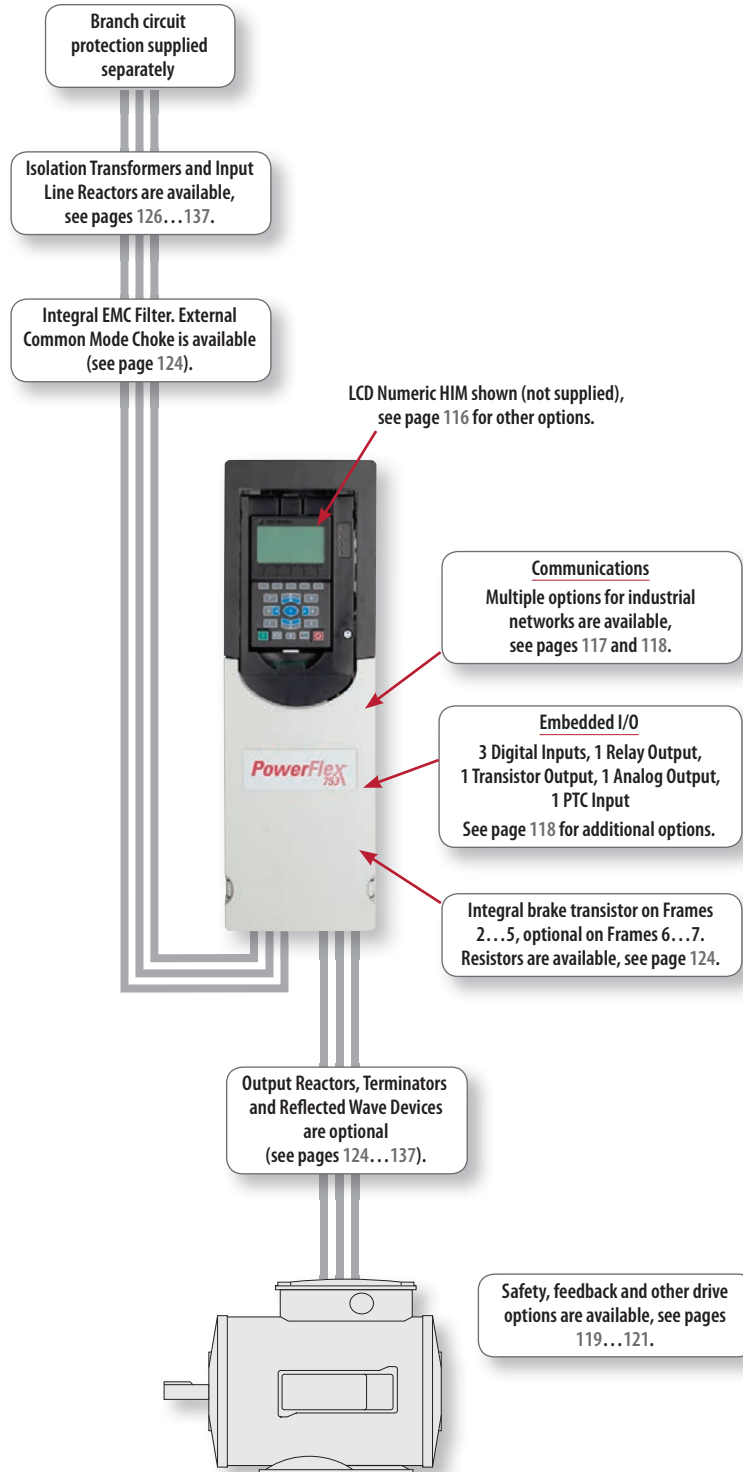

## Additional Information

PowerFlex 750-Series Brochure, publication 750-BR001

PowerFlex 750-Series Technical Data, publication 750-TD001

## Catalog Number Explanation

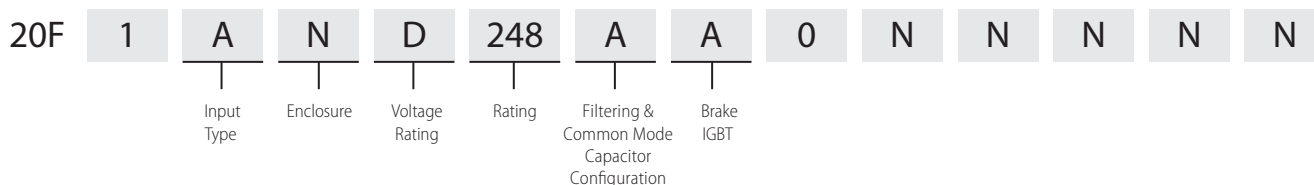

## Product Selection

IP00/IP20, NEMA/UL Type Open &

380...480V AC, Three-Phase Drives

480V AC Input						400V AC Input						Frame Size
Output Amps §			Normal Duty Hp	Heavy Duty Hp	Cat. No.	Output Amps §			Normal Duty kW	Heavy Duty kW	Cat. No. ★	
Cont.	1 Min.	3 Sec.				Cont.	1 Min.	3 Sec.				
2.1	2.3	3.2	1	0.5	20F11RD2P1AAONNNNN	2.1	2.3	3.2	0.75	0.37	20F11RC2P1JAONNNNN	1
3.4	3.7	5.1	2	1.5	20F11RD3P4AAONNNNN	3.5	3.9	5.3	1.5	0.75	20F11RC3P5JAONNNNN	1
5	5.5	7.5	3	2	20F11RD5P0AAONNNNN	5	5.5	7.5	2.2	1.5	20F11RC5P0JAONNNNN	1
8	8.8	12	5	3	20F11RD8P0AAONNNNN	8.7	9.6	13.1	4	2.2	20F11RC8P7JAONNNNN	1
11	12.1	16.5	7.5	5	20F11RD011AAONNNNN	11.5	12.7	17.3	5.5	4	20F11RC011JAONNNNN	1
14	15.4	21	10	7.5	20F11RD014AAONNNNN	15.4	16.9	23.1	7.5	5.5	20F11RC015JAONNNNN	1
2.1	3.1	3.7	1	1	20F11ND2P1AAONNNNN	2.1	3.1	3.7	0.75	0.75	20F11NC2P1JAONNNNN	2
3.4	5.1	6.1	2	2	20F11ND3P4AAONNNNN	3.5	5.2	6.3	1.5	1.5	20F11NC3P5JAONNNNN	2
5	7.5	9	3	3	20F11ND5P0AAONNNNN	5	7.5	9.0	2.2	2.2	20F11NC5P0JAONNNNN	2
8	12	14.4	5	5	20F11ND8P0AAONNNNN	8.7	13	15.6	4	4	20F11NC8P7JAONNNNN	2
11	16.5	19.8	7.5	7.5	20F11ND011AAONNNNN	11.5	17.2	20.7	5.5	5.5	20F11NC011JAONNNNN	2
14 (11)	15.4 (16.5)	21 (21)	10	7.5	20F11ND014AAONNNNN	15.4 (11.5)	16.9 (17.3)	23.1 (23.1)	7.5	5.5	20F11NC015JAONNNNN	2
22 (14)	24.2 (21)	33 (33)	15	10	20F11ND022AAONNNNN	22 (15.4)	24.2 (23.1)	33 (33)	11	7.5	20F11NC022JAONNNNN	2
27 (22)	29.7 (33)	40.5 (40.5)	20	15	20F11ND027AAONNNNN	30 (22)	33 (33)	45 (45)	15	11	20F11NC030JAONNNNN	3
34 (27)	37.4 (40.5)	51 (51)	25	20	20F11ND034AAONNNNN	37 (30)	40.7 (45)	55.5 (55.5)	18.5	15	20F11NC037JAONNNNN	3
40 (34)	44 (51)	60 (61.2)	30	25	20F11ND040AAONNNNN	43 (37)	47.3 (55.5)	64.5 (66.6)	22	18.5	20F11NC043JAONNNNN	3
52 (40)	57.2 (60)	78 (78)	40	30	20F11ND052AAONNNNN	60 (43)	66 (66)	90 (90)	30	22	20F11NC060JAONNNNN	4
65 (52)	71.5 (78)	97.5 (97.5)	50	40	20F11ND065AAONNNNN	72 (60)	79.2 (90)	108 (108)	37	30	20F11NC072JAONNNNN	4
77 (65)	84.7 (97.5)	116 (117)	60	50	20F11ND077AAONNNNN	85 (72)	93.5 (108)	128 (130)	45	37	20F11NC085JAONNNNN	5
96 (77)	106 (116)	144 (144)	75	60	20F11ND096AAONNNNN	104 (85)	114 (128)	156 (156)	55	45	20F11NC104JAONNNNN	5
125 (96)	138 (144)	188 (188)	100	75	20F1AND125ANONNNNN	140 (104)	154 (156)	210 (210)	75	55	20F1ANC140JNONNNNN	6 ♠
156 (125)	172 (188)	234 (234)	125	100	20F1AND156ANONNNNN	170 (140)	187 (210)	255 (255)	90	75	20F1ANC170JNONNNNN	6 ♠
186 (156)	205 (234)	279 (281)	150	125	20F1AND186ANONNNNN	205 (170)	226 (255)	308 (308)	110	90	20F1ANC205JNONNNNN	6 ♠
248 (186)	273 (279)	372 (372)	200	150	20F1AND248ANONNNNN	260 (205)	286 (308)	390 (390)	132	110	20F1ANC260JNONNNNN	6 ♠
302 (248)	332 (372)	453 (453)	250	200	20F1AND302ANONNNNN	302 (260)	332 (390)	453 (468)	160	132	20F1ANC302JNONNNNN	7 ♠
361 (302)	397 (453)	542 (544)	300	250	20F1AND361ANONNNNN	367 (302)	404 (453)	551 (551)	200	160	20F1ANC367JNONNNNN	7 ♠
415 (361)	457 (542)	623 (650)	350	300	20F1AND415ANONNNNN	456 (367)	502 (551)	684 (684)	250	200	20F1ANC456JNONNNNN	7 ♠

& Frames 2...5 are IP20, Frames 6...7 are IP00.

★ The 11th character determines default Filtering and Common Mode Cap jumper configuration. "J" = Installed, "A" = Removed.

♠ Also available with internal Brake IGBT (20F1xxxxxxx A xxxxxx).

§ Some drives have dual current ratings; one for normal duty applications, and one for heavy duty applications (in parenthesis). The drive may be operated at either rating.

IP00/IP20, NEMA/UL Type Open (continued)

Frames 3, 4 and 5 are 600V only drives. Frames 6 and 7 are dual voltage drives and can be operated at 600V or 690V AC.

**Important:** Frames 3, 4, and 5 must NOT be used in common DC input sharing applications with Frame 6 or larger drives. For details, contact your local Rockwell Automation sales office or Allen-Bradley Distributor.

DC Bus terminals are not supplied with AC input Frame 6 and 7 drives.

600V AC, Three-Phase Drives – IP20, NEMA/UL Type 1

Cont.	Output Amps §		Normal Duty Hp	Heavy Duty Hp	Cat. No.	Frame Size
	1 Min.	3 Sec.				
1.7 (0.9)	1.9 (1.4)	2.6 (2.6)	1	0.5	20F11NE1P7AA0N0N0N0N	3
2.7 (1.7)	3.0 (2.6)	4.1 (4.6)	2	1	20F11NE2P7AA0N0N0N0N	3
3.9 (2.7)	4.3 (4.1)	5.9 (7.3)	3	2	20F11NE3P9AA0N0N0N0N	3
6.1 (3.9)	6.7 (5.9)	9.2 (10.5)	5	3	20F11NE6P1AA0N0N0N0N	3
9 (6.1)	9.9 (9.2)	13.5 (16.5)	7.5	5	20F11NE9P0AA0N0N0N0N	3
11 (9)	12.1 (13.5)	16.5 (24.3)	10	7.5	20F11NE011AA0N0N0N0N	3
17 (11)	18.7 (16.5)	25.5 (29.7)	15	10	20F11NE017AA0N0N0N0N	3
22 (17)	24 (26)	33 (46)	20	15	20F11NE022AA0N0N0N0N	3
27 (22)	30 (33)	41 (59)	25	20	20F11NE027AA0N0N0N0N	4
32 (27)	35 (41)	48 (73)	30	25	20F11NE032AA0N0N0N0N	4
41 (32)	45 (48)	62 (86)	40	30	20F11NE041AA0N0N0N0N	5
52 (41)	57 (62)	78 (111)	50	40	20F11NE052AA0N0N0N0N	5

§ These drives have dual current ratings; one for normal duty applications, and one for heavy duty applications (in parenthesis). The drive may be operated at either rating.

600...690V AC, Three-Phase Drives – IP00, NEMA/UL Type Open

600V AC Input					690V AC Input						Frame Size	
Output Amps §			Normal Duty Hp	Heavy Duty Hp	Cat. No.	Output Amps §			Normal Duty kW	Heavy Duty kW		Cat. No. ★
Cont.	1 Min.	3 Sec.				Cont.	1 Min.	3 Sec.				
12 (9.1)	13.2 (13.7)	18 (18)	10 ‡	7.5	20F1ANE012AN0N0N0N0N	12 (9)	13.2 (13.5)	18 (18)	7.5	5.5	20F1ANF012JN0N0N0N0N	6 ♣
18 (11.1)	19.8 (16.7)	27 (27)	15 ‡	10	20F1ANE018AN0N0N0N0N	15 (11.5)	16.5 (17.3)	22.5 (22.5)	11	7.5	20F1ANF015JN0N0N0N0N	6 ♣
23 (18)	25.3 (27)	34.5 (34.5)	20 ‡	15	20F1ANE023AN0N0N0N0N	20 (15)	22 (22.5)	30 (30)	15	11	20F1ANF020JN0N0N0N0N	6 ♣
24 (22)	26.4 (33)	36 (39.6)	20 ‡	20	20F1ANE024AN0N0N0N0N	23 (20)	25.3 (30)	34.5 (36)	18.5	15	20F1ANF023JN0N0N0N0N	6 ♣
28 (23)	30.8 (34.5)	42 (42)	25 ‡	20	20F1ANE028AN0N0N0N0N	30 (23)	33 (34.5)	45 (45)	22	18.5	20F1ANF030JN0N0N0N0N	6 ♣
33 (28)	36.3 (42)	49.5 (50.4)	30 ‡	25	20F1ANE033AN0N0N0N0N	34 (30)	37.4 (45)	51 (54)	30	22	20F1ANF034JN0N0N0N0N	6 ♣
42 (33)	46.2 (49.5)	63 (63)	40 ‡	30	20F1ANE042AN0N0N0N0N	46 (34)	50.6 (51)	69 (69)	37	30	20F1ANF046JN0N0N0N0N	6 ♣
53 (42)	58.3 (63)	79.5 (79.5)	50 ‡	40	20F1ANE053AN0N0N0N0N	50 (46)	55 (69)	75 (82.8)	45	37	20F1ANF050JN0N0N0N0N	6 ♣
63 (52)	69.3 (78)	94.5 (94.5)	60	50	20F1ANE063AN0N0N0N0N	61 (50)	67.1 (75)	91.5 (91.5)	55	45	20F1ANF061JN0N0N0N0N	6 ♣
77 (63)	84.7 (94.5)	116 (116)	75	60	20F1ANE077AN0N0N0N0N	82 (61)	90.2 (91.5)	123 (123)	75	55	20F1ANF082JN0N0N0N0N	6 ♣
99 (77)	109 (116)	149 (149)	100	75	20F1ANE099AN0N0N0N0N	98 (82)	108 (123)	147 (148)	90	75	20F1ANF098JN0N0N0N0N	6 ♣
125 (99)	138 (149)	188 (188)	125	100	20F1ANE125AN0N0N0N0N	119 (98)	131 (147)	179 (179)	110	90	20F1ANF119JN0N0N0N0N	6 ♣
144 (125)	158 (188)	216 (225)	150	125	20F1ANE144AN0N0N0N0N	142 (119)	156 (179)	213 (214)	132	110	20F1ANF142JN0N0N0N0N	6 ♣
192 (144)	211 (216)	288 (288)	200	150	20F1ANE192AN0N0N0N0N	171 (142)	188 (213)	257 (257)	160	132	20F1ANF171JN0N0N0N0N	7 ♣
242 (192)	266 (288)	363 (363)	250	200	20F1ANE242AN0N0N0N0N	212 (171)	233 (257)	318 (318)	200	160	20F1ANF212JN0N0N0N0N	7 ♣
289 (242)	318 (318)	434 (436)	300	250	20F1ANE289AN0N0N0N0N	263 (212)	289 (289)	395 (395)	250	200	20F1ANF263JN0N0N0N0N	7 ♣

★ The 11th character determines default Filtering and Common Mode Cap jumper configuration. "J" = Installed, "A" = Removed.

‡ Alternate 600V ratings when connected to drives 60 Hp and greater in common DC input applications with uncontrolled front ends.

§ These drives have dual current ratings; one for normal duty applications, and one for heavy duty applications (in parenthesis). The drive may be operated at either rating.

♣ Also available with internal Brake IGBT (20F1xxxxxxx A xxxxxx).

## Flange Mount

Front = IP20, NEMA/UL Type Open, Back/Heatsink = IP66, NEMA/UL Type 4X

## 380...480V AC, Three-Phase Drives

480V AC Input					400V AC Input					Frame Size		
Output Amps §			Normal Duty Hp	Heavy Duty Hp	Cat. No.	Output Amps §			Normal Duty kW		Heavy Duty kW	Cat. No. ★
Cont.	1 Min.	3 Sec.				Cont.	1 Min.	3 Sec.				
2.1	3.1	3.7	1	1	20F11FD2P1AA0NNNNN	2.1	3.1	3.7	0.75	0.75	20F11FC2P1JA0NNNNN	2
3.4	5.1	6.1	2	2	20F11FD3P4AA0NNNNN	3.5	5.2	6.3	1.5	1.5	20F11FC3P5JA0NNNNN	2
5	7.5	9	3	3	20F11FD5P0AA0NNNNN	5	7.5	9.0	2.2	2.2	20F11FC5P0JA0NNNNN	2
8	12	14.4	5	5	20F11FD8P0AA0NNNNN	8.7	13	15.6	4	4	20F11FC8P7JA0NNNNN	2
11	16.5	19.8	7.5	7.5	20F11FD011AA0NNNNN	11.5	17.2	20.7	5.5	5.5	20F11FC011JA0NNNNN	2
14 (11)	15.4 (16.5)	21 (21)	10	7.5	20F11FD014AA0NNNNN	15.4 (11.5)	16.9 (17.3)	23.1 (23.1)	7.5	5.5	20F11FC015JA0NNNNN	2
22 (14)	24.2 (21)	33 (33)	15	10	20F11FD022AA0NNNNN	22 (15.4)	24.2 (23.1)	33 (33)	11	7.5	20F11FC022JA0NNNNN	2
27 (22)	29.7 (33)	40.5 (40.5)	20	15	20F11FD027AA0NNNNN	30 (22)	33 (33)	45 (45)	15	11	20F11FC030JA0NNNNN	3
34 (27)	37.4 (40.5)	51 (51)	25	20	20F11FD034AA0NNNNN	37 (30)	40.7 (45)	55.5 (55.5)	18.5	15	20F11FC037JA0NNNNN	3
40 (34)	44 (51)	60 (61.2)	30	25	20F11FD040AA0NNNNN	43 (37)	47.3 (55.5)	64.5 (66.6)	22	18.5	20F11FC043JA0NNNNN	3
52 (40)	57.2 (60)	78 (78)	40	30	20F11FD052AA0NNNNN	60 (43)	66 (66)	90 (90)	30	22	20F11FC060JA0NNNNN	4
65 (52)	71.5 (78)	97.5 (97.5)	50	40	20F11FD065AA0NNNNN	72 (60)	79.2 (90)	108 (108)	37	30	20F11FC072JA0NNNNN	4
77 (65)	84.7 (97.5)	116 (117)	60	50	20F11FD077AA0NNNNN	85 (72)	93.5 (108)	128 (130)	45	37	20F11FC085JA0NNNNN	5
96 (77)	106 (116)	144 (144)	75	60	20F11FD096AA0NNNNN	104 (85)	114 (128)	156 (156)	55	45	20F11FC104JA0NNNNN	5

**Note:** Frames 6...7 require a user installed flange kit with an IP00, NEMA/UL Type Open drive.

★ The 11th character determines default Filtering and Common Mode Cap jumper configuration. "J" = Installed, "A" = Removed.

§ Some drives have dual current ratings; one for normal duty applications, and one for heavy duty applications (in parenthesis). The drive may be operated at either rating.

## 600V AC, Three-Phase Drives

Output Amps §			Normal Duty Hp	Heavy Duty Hp	Cat. No.	Frame Size
Cont.	1 Min.	3 Sec.				
1.7 (0.9)	1.9 (1.4)	2.6 (2.6)	1	0.5	20F11FE1P7AA0NNNNN	3
2.7 (1.7)	3.0 (2.6)	4.1 (4.6)	2	1	20F11FE2P7AA0NNNNN	3
3.9 (2.7)	4.3 (4.1)	5.9 (7.3)	3	2	20F11FE3P9AA0NNNNN	3
6.1 (3.9)	6.7 (5.9)	9.2 (10.5)	5	3	20F11FE6P1AA0NNNNN	3
9 (6.1)	9.9 (9.2)	13.5 (16.5)	7.5	5	20F11FE9P0AA0NNNNN	3
11 (9)	12.1 (13.5)	16.5 (24.3)	10	7.5	20F11FE011AA0NNNNN	3
17 (11)	18.7 (16.5)	25.5 (29.7)	15	10	20F11FE017AA0NNNNN	3
22 (17)	24 (26)	33 (46)	20	15	20F11FE022AA0NNNNN	3
27 (22)	30 (33)	41 (59)	25	20	20F11FE027AA0NNNNN	4
32 (27)	35 (41)	48 (73)	30	25	20F11FE032AA0NNNNN	4
41 (32)	45 (48)	62 (86)	40	30	20F11FE041AA0NNNNN	5
52 (41)	57 (62)	78 (111)	50	40	20F11FE052AA0NNNNN	5

§ These drives have dual current ratings; one for normal duty applications, and one for heavy duty applications (in parenthesis). The drive may be operated at either rating.



## IP54, NEMA/UL Type 12

## 380...480V AC, Three-Phase Drives

480V AC Input					400V AC Input						Frame Size	
Output Amps §			Normal Duty Hp	Heavy Duty Hp	Cat. No.	Output Amps §			Normal Duty kW	Heavy Duty kW		Cat. No. ★
Cont.	1 Min.	3 Sec.				Cont.	1 Min.	3 Sec.				
2.1	3.1	3.7	1	1	20F11GD2P1AAONNNNN	2.1	3.1	3.7	0.75	0.75	20F11GC2P1JAONNNNN	2
3.4	5.1	6.1	2	2	20F11GD3P4AAONNNNN	3.5	5.2	6.3	1.5	1.5	20F11GC3P5JAONNNNN	2
5	7.5	9	3	3	20F11GD5P0AAONNNNN	5	7.5	9.0	2.2	2.2	20F11GC5P0JAONNNNN	2
8	12	14.4	5	5	20F11GD8P0AAONNNNN	8.7	13	15.6	4	4	20F11GC8P7JAONNNNN	2
11	16.5	19.8	7.5	7.5	20F11GD011AAONNNNN	11.5	17.2	20.7	5.5	5.5	20F11GC011JAONNNNN	2
14 (11)	15.4 (16.5)	21 (21)	10	7.5	20F11GD014AAONNNNN	15.4 (11.5)	16.9 (17.3)	23.1 (23.1)	7.5	5.5	20F11GC015JAONNNNN	2
22 (14)	24.2 (21)	33 (33)	15	10	20F11GD022AAONNNNN	22 (15.4)	24.2 (23.1)	33 (33)	11	7.5	20F11GC022JAONNNNN	2
27 (22)	29.7 (33)	40.5 (40.5)	20	15	20F11GD027AAONNNNN	30 (22)	33 (33)	45 (45)	15	11	20F11GC030JAONNNNN	3
34 (27)	37.4 (40.5)	51 (51)	25	20	20F11GD034AAONNNNN	37 (30)	40.7 (45)	55.5 (55.5)	18.5	15	20F11GC037JAONNNNN	3
40 (34)	44 (51)	60 (61.2)	30	25	20F11GD040AAONNNNN	43 (37)	47.3 (55.5)	64.5 (66.6)	22	18.5	20F11GC043JAONNNNN	3
52 (40)	57.2 (60)	78 (78)	40	30	20F11GD052AAONNNNN	60 (43)	66 (66)	90 (90)	30	22	20F11GC060JAONNNNN	4
65 (52)	71.5 (78)	97.5 (97.5)	50	40	20F11GD065AAONNNNN	72 (60)	79.2 (90)	108 (108)	37	30	20F11GC072JAONNNNN	5
77 (65)	84.7 (97.5)	116 (117)	60	50	20F11GD077AAONNNNN	85 (72)	93.5 (108)	128 (130)	45	37	20F11GC085JAONNNNN	5
96 (77)	106 (116)	144 (144)	75	60	20F1AGD096ANONNNNN	104 (85)	114 (128)	156 (156)	55	45	20F1AGC104JNONNNNN	6 ♣
125 (96)	138 (144)	188 (188)	100	75	20F1AGD125ANONNNNN	140 (104)	154 (156)	210 (210)	75	55	20F1AGC140JNONNNNN	6 ♣
156 (125)	172 (188)	234 (234)	125	100	20F1AGD156ANONNNNN	170 (140)	187 (210)	255 (255)	90	75	20F1AGC170JNONNNNN	6 ♣
186 (156)	205 (234)	279 (281)	150	125	20F1AGD186ANONNNNN	205 (170)	226 (255)	308 (308)	110	90	20F1AGC205JNONNNNN	6 ♣
248 (186)	273 (279)	372 (372)	200	150	20F1AGD248ANONNNNN	260 (205)	286 (308)	390 (390)	132	110	20F1AGC260JNONNNNN	7 ♣
302 (248)	332 (372)	453 (453)	250	200	20F1AGD302ANONNNNN	302 (260)	332 (390)	453 (468)	160	132	20F1AGC302JNONNNNN	7 ♣
361 (302)	397 (453)	542 (544)	300	250	20F1AGD361ANONNNNN	367 (302)	404 (453)	551 (551)	200	160	20F1AGC367JNONNNNN	7 ♣
415 (361)	457 (542)	623 (650)	350	300	20F1AGD415ANONNNNN	456 (367)	502 (551)	684 (684)	250	200	20F1AGC456JNONNNNN	7 ♣

★ The 11th character determines default Filtering and Common Mode Cap jumper configuration. "J" = Installed, "A" = Removed.

♣ Also available with internal Brake IGBT (20F1xxxxxx A xxxxx).

§ Some drives have dual current ratings; one for normal duty applications, and one for heavy duty applications (in parenthesis). The drive may be operated at either rating.

## IP54, NEMA/UL Type 12 (continued)

Frames 3, 4 and 5 are 600V only drives. Frames 6 and 7 are dual voltage drives and can be operated at 600V or 690V AC.

**Important:** Frames 3, 4, and 5 must NOT be used in common DC input sharing applications with Frame 6 or larger drives. For details, contact your local Rockwell Automation sales office or Allen-Bradley Distributor.

DC Bus terminals are not supplied with AC input Frame 6 and 7 drives.

### 600V AC, Three-Phase Drives

Cont.	Output Amps §		Normal Duty Hp	Heavy Duty Hp	Cat. No.	Frame Size
	1 Min.	3 Sec.				
1.7 (0.9)	1.9 (1.4)	2.6 (2.6)	1	0.5	20F11GE1P7AAONNNNN	3
2.7 (1.7)	3.0 (2.6)	4.1 (4.6)	2	1	20F11GE2P7AAONNNNN	3
3.9 (2.7)	4.3 (4.1)	5.9 (7.3)	3	2	20F11GE3P9AAONNNNN	3
6.1 (3.9)	6.7 (5.9)	9.2 (10.5)	5	3	20F11GE6P1AAONNNNN	3
9 (6.1)	9.9 (9.2)	13.5 (16.5)	7.5	5	20F11GE9P0AAONNNNN	3
11 (9)	12.1 (13.5)	16.5 (24.3)	10	7.5	20F11GE011AAONNNNN	3
17 (11)	18.7 (16.5)	25.5 (29.7)	15	10	20F11GE017AAONNNNN	3
22 (17)	24 (26)	33 (46)	20	15	20F11GE022AAONNNNN	3
27 (22)	30 (33)	41 (59)	25	20	20F11GE027AAONNNNN	4
32 (27)	35 (41)	48 (73)	30	25	20F11GE032AAONNNNN	4
41 (32)	45 (48)	62 (86)	40	30	20F11GE041AAONNNNN	5
52 (41)	57 (62)	78 (111)	50	40	20F11GE052AAONNNNN	5

§ These drives have dual current ratings; one for normal duty applications, and one for heavy duty applications (in parenthesis). The drive may be operated at either rating.

### 600...690V AC, Three-Phase Drives

600V AC Input					690V AC Input							Frame Size
Output Amps §			Normal Duty Hp	Heavy Duty Hp	Cat. No.	Output Amps §			Normal Duty kW	Heavy Duty kW	Cat. No. ★	
Cont.	1 Min.	3 Sec.				Cont.	1 Min.	3 Sec.				
12 (9.1)	13.2 (13.7)	18 (18)	10 ‡	7.5	20F1AGE012ANONNNNN	12 (9)	13.2 (13.5)	18 (18)	7.5	5.5	20F1AGF012JNONNNNN	6 ♣
18 (11.1)	19.8 (16.7)	27 (27)	15 ‡	10	20F1AGE018ANONNNNN	15 (11.5)	16.5 (17.3)	22.5 (22.5)	11	7.5	20F1AGF015JNONNNNN	6 ♣
23 (18)	25.3 (27)	34.5 (34.5)	20 ‡	15	20F1AGE023ANONNNNN	20 (15)	22 (22.5)	30 (30)	15	11	20F1AGF020JNONNNNN	6 ♣
24 (22)	26.4 (33)	36 (39.6)	20 ‡	20	20F1AGE024ANONNNNN	23 (20)	25.3 (30)	34.5 (36)	18.5	15	20F1AGF023JNONNNNN	6 ♣
28 (23)	30.8 (34.5)	42 (42)	25 ‡	20	20F1AGE028ANONNNNN	30 (23)	33 (34.5)	45 (45)	22	18.5	20F1AGF030JNONNNNN	6 ♣
33 (28)	36.3 (42)	49.5 (50.4)	30 ‡	25	20F1AGE033ANONNNNN	34 (30)	37.4 (45)	51 (54)	30	22	20F1AGF034JNONNNNN	6 ♣
42 (33)	46.2 (49.5)	63 (63)	40 ‡	30	20F1AGE042ANONNNNN	46 (34)	50.6 (51)	69 (69)	37	30	20F1AGF046JNONNNNN	6 ♣
53 (42)	58.3 (63)	79.5 (79.5)	50 ‡	40	20F1AGE053ANONNNNN	50 (46)	55 (69)	75 (82.8)	45	37	20F1AGF050JNONNNNN	6 ♣
63 (52)	69.3 (78)	94.5 (94.5)	60	50	20F1AGE063ANONNNNN	61 (50)	67.1 (75)	91.5 (91.5)	55	45	20F1AGF061JNONNNNN	6 ♣
77 (63)	84.7 (94.5)	116 (116)	75	60	20F1AGE077ANONNNNN	82 (61)	90.2 (91.5)	123 (123)	75	55	20F1AGF082JNONNNNN	6 ♣
99 (77)	109 (116)	149 (149)	100	75	20F1AGE099ANONNNNN	98 (82)	108 (123)	147 (148)	90	75	20F1AGF098JNONNNNN	6 ♣
125 (99)	138 (149)	188 (188)	125	100	20F1AGE125ANONNNNN	119 (98)	131 (147)	179 (179)	110	90	20F1AGF119JNONNNNN	6 ♣
144 (125)	158 (188)	216 (225)	150	125	20F1AGE144ANONNNNN	142 (119)	156 (179)	213 (214)	132	110	20F1AGF142JNONNNNN	6 ♣
192 (144)	211 (216)	288 (288)	200	150	20F1AGE192ANONNNNN	171 (142)	188 (213)	257 (257)	160	132	20F1AGF171JNONNNNN	7 ♣
242 (192)	266 (288)	363 (363)	250	200	20F1AGE242ANONNNNN	212 (171)	233 (257)	318 (318)	200	160	20F1AGF212JNONNNNN	7 ♣
289 (242)	318 (318)	434 (436)	300	250	20F1AGE289ANONNNNN	263 (212)	289 (289)	395 (395)	250	200	20F1AGF263JNONNNNN	7 ♣

★ The 11th character determines default Filtering and Common Mode Cap jumper configuration. "J" = Installed, "A" = Removed.

‡ Alternate 600V ratings when connected to drives 60 Hp and greater in common DC input applications with uncontrolled front ends.

§ These drives have dual current ratings; one for normal duty applications, and one for heavy duty applications (in parenthesis). The drive may be operated at either rating.

♣ Also available with internal Brake IGBT (20F1xxxxxx A xxxxxx).

## Approximate Dimensions and Weights

Dimensions are in mm (in.) - weights are in kg (lb)

### IP00/IP20, NEMA/UL Type Open

Frame	H	W	D	Weight
1	400.5 (15.77)	110.0 (4.33)	211.0 (8.31)	6.00 (12.75)
2	424.2 (16.70)	134.5 (5.30)	212.0 (8.35)	7.80 (17.2)
3	454.0 (17.87)	190.0 (7.48)	212.0 (8.35)	11.80 (26.1)
4	474.0 (18.66)	222.0 (8.74)	212.0 (8.35)	13.60 (30.0)
5	550.0 (21.65)	270.0 (10.63)	212.0 (8.35)	20.40 (45.0)
6	665.5 (26.20)	308.0 (12.13)	346.4 (13.64)	38.60 (85.0)
7	881.5 (34.70)	430.0 (16.93)	349.6 (13.76)	72.60...108.90 (160.0...240.0)

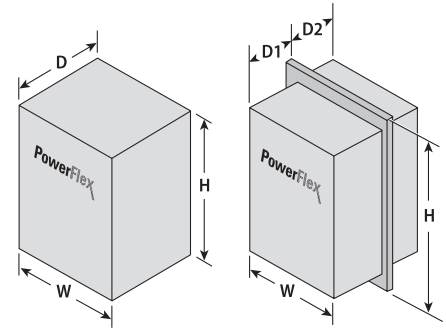

### IP54, NEMA/UL Type 12

Frame	H	W	D	Weight ★
2	543.2 (21.39)	215.3 (8.48)	222.2 (8.75)	8.00 (17.0)
3	551.0 (21.69)	268.0 (10.55)	220.1 (8.67)	12.00 (26.0)
4	571.0 (22.48)	300.0 (11.81)	220.1 (8.67)	14.00 (30.0)
5	647.0 (25.47)	348.0 (13.70)	220.1 (8.67)	20.00 (45.0)
6	1298.3 (51.11)	609.4 (23.99)	464.7 (18.30)	91.00 (200.0)
7	1614.0 (63.54)	609.4 (23.99)	464.7 (18.30)	162.00 (357.0)

★ Weights are approximate. Refer to the PowerFlex 750-Series Technical Data for detailed weight information.

### Flange Mount

Frame	H	W	D1	D2	Weight ★
2	481.8 (18.97)	206.2 (8.12)	148.3 (5.84)	63.7 (2.51)	8.00 (17.0)
3	515.0 (20.28)	260.0 (10.24)	127.4 (5.02)	84.6 (3.33)	12.00 (26.0)
4	535.0 (21.06)	292.0 (11.50)	127.4 (5.02)	84.6 (3.33)	14.00 (30.0)
5	611.0 (24.06)	340.0 (13.39)	127.4 (5.02)	84.6 (3.33)	20.00 (45.0)
6	665.5 (26.20)	308.0 (12.13)	208.4 (8.20)	138.0 (5.43)	38.00 (84.0)
7	875.0 (34.45)	430.0 (16.93)	208.4 (8.20)	138.0 (5.43)	96.00 (212.0)

★ Weights are approximate. Refer to the PowerFlex 750-Series Technical Data for detailed weight information.

# PowerFlex 755 AC Drive

Designed for ease of integration, application flexibility and performance the PowerFlex 755 AC drive provides improved functionality across many manufacturing systems. The PowerFlex 755 AC drive is designed to maximize user's investment and help improve productivity. Ideal for applications that require safety, high motor control performance, and application flexibility, the PowerFlex 755 is highly functional and cost effective solution.

The PowerFlex 755 AC drive can be configured with drive instructions embedded in Allen-Bradley Logix Programmable Automation Controllers (PAC).

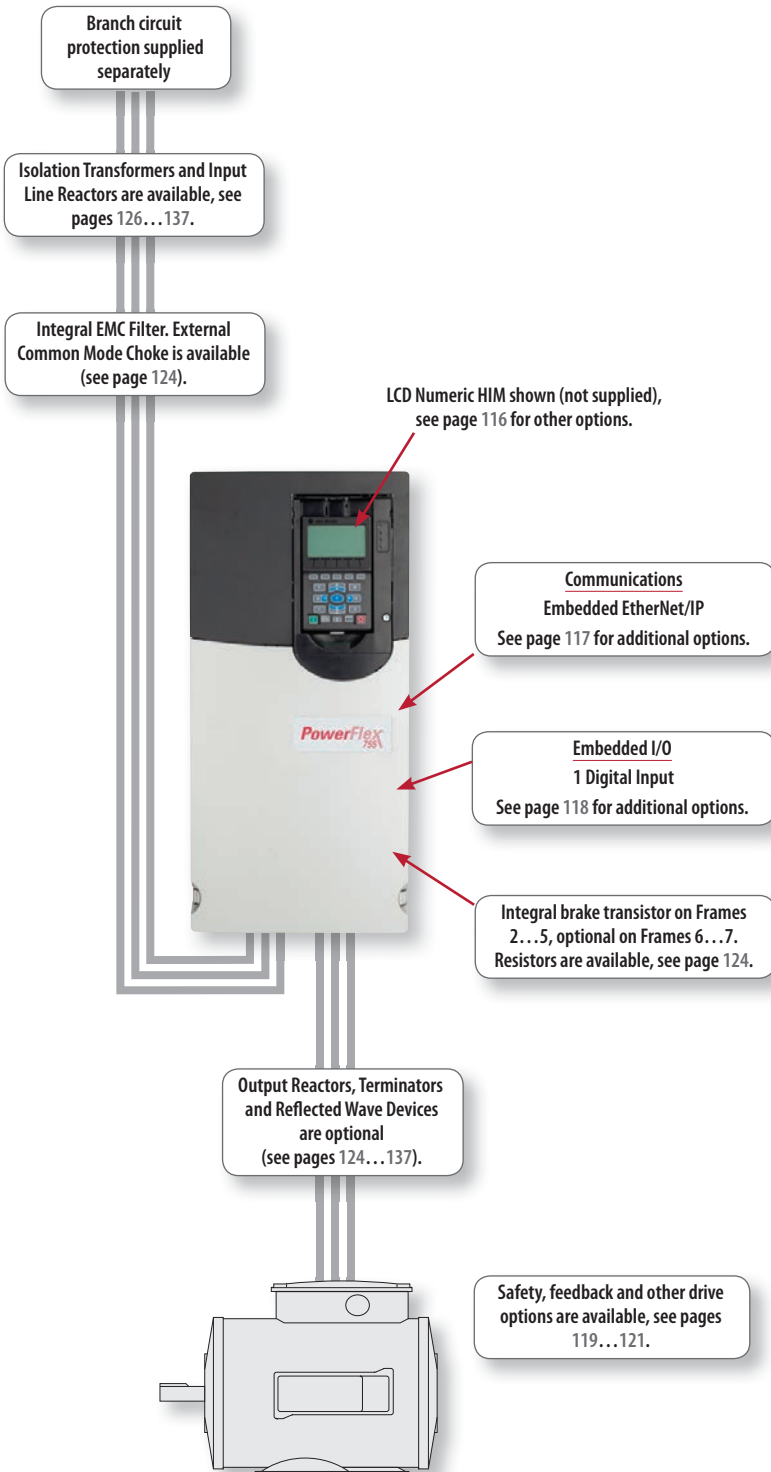

## PowerFlex 755 at a glance

### Ratings

380...480V:	0.75...1400 kW / 1.0...2000 Hp / 2.1...2330 A
600V:	1.0...1500 Hp / 1.7...1530 A
690V:	7.5...1500 kW / 12...1485 A

### Motor Control

- V/Hz Control
- Sensorless Vector Control
- Vector Control with FORCE Technology (with and without encoder)
- Surface Mount Permanent Magnet:
  - Frames 2...7 (with and without encoder)
  - Frames 8...10 (with encoder)
- Interior Permanent Magnet:
  - Frames 2...7 (with and without encoder)
  - Frames 8...10 (with encoder)

### Enclosures

- IP00/IP20, NEMA/UL Type Open
- Flange Mount
- IP54/NEMA/UL Type 12
- IP20, NEMA/UL Type 1 (MCC Style Cabinet)
- IP54, NEMA Type 12 (MCC Style Cabinet)

### Safety

- Safe Torque-Off PLe/SIL3 Cat. 3
- Safe Speed Monitor PLe/SIL3 Cat. 4

### Additional Features

- Automatic Device Configuration
- Configure and control with embedded instruction sets in Studio 5000 Logix Designer
- Predictive Diagnostics
- Adjustable Voltage Control
- Five option slots for I/O, feedback, safety, auxiliary control power, communications
- Accurate positioning with PCAM, Indexer, Electronic Gearing, and speed/position profiling
- Incremental, Absolute and High Resolution feedback supported
- TorqProve for lifting applications
- Pump Jack and Pump Off for oil well applications
- Pjump and Traverse for Fibers application
- Conformal Coating
- DC Link Choke
- AC line fuses included with Frame 8...10 drives
- Roll-out design for Frame 8...10 drives

### Certifications

- ABS (Frames 2...8, 400/480V AC)
- ATEX Certified with appropriate options
- C-Tick
- c-UL-us
- CE
- EPRI/SEMI F47
- GOST-R (Frames 2...8, 400/480V AC)
- Lloyd's Register (Frames 2...8, 400/480V AC)
- RINA (Frames 2...8, 400/480V AC)
- RoHS compliant materials
- FS ISO/EN13849-1 (EN954-1) with Safe Torque-Off option

### Options

See pages 116...137

## Additional Information

PowerFlex 750-Series Brochure, publication 750-BR001  
 PowerFlex 750-Series Technical Data, publication 750-TD001

## Catalog Number Explanation

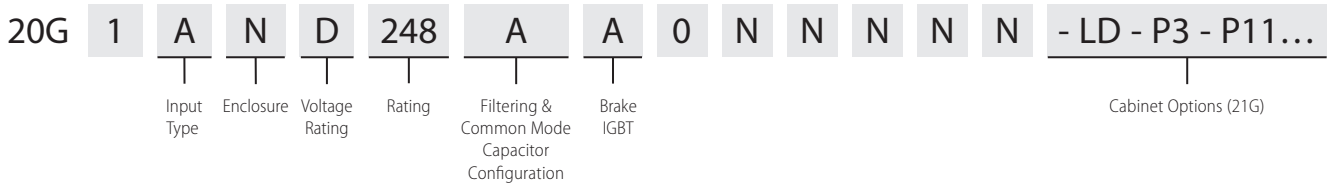

## Product Selection

IP00/IP20, NEMA/UL Type Open \*

### 380...480V AC, Three-Phase Drives

480V AC Input						400V AC Input						Frame Size
Output Amps §			Normal Duty Hp	Heavy Duty Hp	Cat. No.	Output Amps §			Normal Duty kW	Heavy Duty kW	Cat. No. ★	
Cont.	1 Min.	3 Sec.				Cont.	1 Min.	3 Sec.				
2.1	2.3	3.2	1	0.5	20G11RD2P1AA0NNNNN	2.1	2.3	3.2	0.75	0.37	20G11RC2P1JA0NNNNN	1
3.4	3.7	5.1	2	1.5	20G11RD3P4AA0NNNNN	3.5	3.9	5.3	1.5	0.75	20G11RC3P5JA0NNNNN	1
5	5.5	7.5	3	2	20G11RD5P0AA0NNNNN	5	5.5	7.5	2.2	1.5	20G11RC5P0JA0NNNNN	1
8	8.8	12	5	3	20G11RD8P0AA0NNNNN	8.7	9.6	13.1	4	2.2	20G11RC8P7JA0NNNNN	1
11	12.1	16.5	7.5	5	20G11RD011AA0NNNNN	11.5	12.7	17.3	5.5	4	20G11RC011JA0NNNNN	1
14	15.4	21	10	7.5	20G11RD014AA0NNNNN	15.4	16.9	23.1	7.5	5.5	20G11RC015JA0NNNNN	1
2.1	3.1	3.7	1	1	20G11ND2P1AA0NNNNN	2.1	3.1	3.7	0.75	0.75	20G11NC2P1JA0NNNNN	2
3.4	5.1	6.1	2	2	20G11ND3P4AA0NNNNN	3.5	5.2	6.3	1.5	1.5	20G11NC3P5JA0NNNNN	2
5	7.5	9	3	3	20G11ND5P0AA0NNNNN	5	7.5	9.0	2.2	2.2	20G11NC5P0JA0NNNNN	2
8	12	14.4	5	5	20G11ND8P0AA0NNNNN	8.7	13	15.6	4	4	20G11NC8P7JA0NNNNN	2
11	16.5	19.8	7.5	7.5	20G11ND011AA0NNNNN	11.5	17.2	20.7	5.5	5.5	20G11NC011JA0NNNNN	2
14 (11)	15.4 (16.5)	21 (21)	10	7.5	20G11ND014AA0NNNNN	15.4 (11.5)	16.9 (17.3)	23.1 (23.1)	7.5	5.5	20G11NC015JA0NNNNN	2
22 (14)	24.2 (21)	33 (33)	15	10	20G11ND022AA0NNNNN	22 (15.4)	24.2 (23.1)	33 (33)	11	7.5	20G11NC022JA0NNNNN	2
27 (22)	29.7 (33)	40.5 (40.5)	20	15	20G11ND027AA0NNNNN	30 (22)	33 (33)	45 (45)	15	11	20G11NC030JA0NNNNN	3
34 (27)	37.4 (40.5)	51 (51)	25	20	20G11ND034AA0NNNNN	37 (30)	40.7 (45)	55.5 (55.5)	18.5	15	20G11NC037JA0NNNNN	3
40 (34)	44 (51)	60 (61.2)	30	25	20G11ND040AA0NNNNN	43 (37)	47.3 (55.5)	64.5 (66.6)	22	18.5	20G11NC043JA0NNNNN	3
52 (40)	57.2 (60)	78 (78)	40	30	20G11ND052AA0NNNNN	60 (43)	66 (66)	90 (90)	30	22	20G11NC060JA0NNNNN	4
65 (52)	71.5 (78)	97.5 (97.5)	50	40	20G11ND065AA0NNNNN	72 (60)	79.2 (90)	108 (108)	37	30	20G11NC072JA0NNNNN	4
77 (65)	84.7 (97.5)	116 (117)	60	50	20G11ND077AA0NNNNN	85 (72)	93.5 (108)	128 (130)	45	37	20G11NC085JA0NNNNN	5
96 (77)	106 (116)	144 (144)	75	60	20G11ND096AA0NNNNN	104 (85)	114 (128)	156 (156)	55	45	20G11NC104JA0NNNNN	5
125 (96)	138 (144)	188 (188)	100	75	20G11ND125AN0NNNNN	140 (104)	154 (156)	210 (210)	75	55	20G11NC140JN0NNNNN	6 ♣
156 (125)	172 (188)	234 (234)	125	100	20G11ND156AN0NNNNN	170 (140)	187 (210)	255 (255)	90	75	20G11NC170JN0NNNNN	6 ♣
186 (156)	205 (234)	279 (281)	150	125	20G11ND186AN0NNNNN	205 (170)	226 (255)	308 (308)	110	90	20G11NC205JN0NNNNN	6 ♣
248 (186)	273 (279)	372 (372)	200	150	20G11ND248AN0NNNNN	260 (205)	286 (308)	390 (390)	132	110	20G11NC260JN0NNNNN	6 ♣
302 (248)	332 (372)	453 (453)	250	200	20G11ND302AN0NNNNN	302 (260)	332 (390)	453 (468)	160	132	20G11NC302JN0NNNNN	7 ♣
361 (302)	397 (453)	542 (544)	300	250	20G11ND361AN0NNNNN	367 (302)	404 (453)	551 (551)	200	160	20G11NC367JN0NNNNN	7 ♣
415 (361)	457 (542)	623 (650)	350	300	20G11ND415AN0NNNNN	456 (367)	502 (551)	684 (684)	250	200	20G11NC456JN0NNNNN	7 ♣

♣ Frames 1...5 are IP20, Frames 6...7 are IP00.

★ The 11th character determines default Filtering and Common Mode Cap jumper configuration. "J" = Installed, "A" = Removed.

♣ Also available with internal Brake IGBT (20G1xxxxxx A xxxxxx).

§ Some drives have dual current ratings; one for normal duty applications, and one for heavy duty applications (in parenthesis). The drive may be operated at either rating.

## IP00/IP20, NEMA/UL Type Open (continued)

Frames 3, 4 and 5 are 600V only drives. Frames 6 and 7 are dual voltage drives and can be operated at 600V or 690V AC.

**Important:** Frames 3, 4, and 5 must NOT be used in common DC input sharing applications with Frame 6 or larger drives. For details, contact your local Rockwell Automation sales office or Allen-Bradley Distributor.

DC Bus terminals are not supplied with AC input Frame 6 and 7 drives.

### 600V AC, Three-Phase Drives – IP20, NEMA/UL Type 1

Output Amps §			Normal Duty Hp	Heavy Duty Hp	Cat. No.	Frame Size
Cont.	1 Min.	3 Sec.				
1.7 (0.9)	1.9 (1.4)	2.6 (2.6)	1	0.5	20G11NE1P7AAONNNNN	3
2.7 (1.7)	3.0 (2.6)	4.1 (4.6)	2	1	20G11NE2P7AAONNNNN	3
3.9 (2.7)	4.3 (4.1)	5.9 (7.3)	3	2	20G11NE3P9AAONNNNN	3
6.1 (3.9)	6.7 (5.9)	9.2 (10.5)	5	3	20G11NE6P1AAONNNNN	3
9 (6.1)	9.9 (9.2)	13.5 (16.5)	7.5	5	20G11NE9P0AAONNNNN	3
11 (9)	12.1 (13.5)	16.5 (24.3)	10	7.5	20G11NE011AAONNNNN	3
17 (11)	18.7 (16.5)	25.5 (29.7)	15	10	20G11NE017AAONNNNN	3
22 (17)	24 (26)	33 (46)	20	15	20G11NE022AAONNNNN	3
27 (22)	30 (33)	41 (59)	25	20	20G11NE027AAONNNNN	4
32 (27)	35 (41)	48 (73)	30	25	20G11NE032AAONNNNN	4
41 (32)	45 (48)	62 (86)	40	30	20G11NE041AAONNNNN	5
52 (41)	57 (62)	78 (111)	50	40	20G11NE052AAONNNNN	5

§ These drives have dual current ratings; one for normal duty applications, and one for heavy duty applications (in parenthesis). The drive may be operated at either rating.

### 600...690V AC, Three-Phase Drives – IP00, NEMA/UL Type Open

600V AC Input					690V AC Input						Frame Size	
Output Amps §			Normal Duty Hp	Heavy Duty Hp	Cat. No.	Output Amps §			Normal Duty kW	Heavy Duty kW		Cat. No. ★
Cont.	1 Min.	3 Sec.				Cont.	1 Min.	3 Sec.				
12 (9.1)	13.2 (13.7)	18 (18)	10 ‡	7.5	20G1ANE012ANONNNNN	12 (9)	13.2 (13.5)	18 (18)	7.5	5.5	20G1ANF012JN0NNNNN	6 ♣
18 (11.1)	19.8 (16.7)	27 (27)	15 ‡	10	20G1ANE018ANONNNNN	15 (11.5)	16.5 (17.3)	22.5 (22.5)	11	7.5	20G1ANF015JN0NNNNN	6 ♣
23 (18)	25.3 (27)	34.5 (34.5)	20 ‡	15	20G1ANE023ANONNNNN	20 (15)	22 (22.5)	30 (30)	15	11	20G1ANF020JN0NNNNN	6 ♣
24 (22)	26.4 (33)	36 (39.6)	20 ‡	20	20G1ANE024ANONNNNN	23 (20)	25.3 (30)	34.5 (36)	18.5	15	20G1ANF023JN0NNNNN	6 ♣
28 (23)	30.8 (34.5)	42 (42)	25 ‡	20	20G1ANE028ANONNNNN	30 (23)	33 (34.5)	45 (45)	22	18.5	20G1ANF030JN0NNNNN	6 ♣
33 (28)	36.3 (42)	49.5 (50.4)	30 ‡	25	20G1ANE033ANONNNNN	34 (30)	37.4 (45)	51 (54)	30	22	20G1ANF034JN0NNNNN	6 ♣
42 (33)	46.2 (49.5)	63 (63)	40 ‡	30	20G1ANE042ANONNNNN	46 (34)	50.6 (51)	69 (69)	37	30	20G1ANF046JN0NNNNN	6 ♣
53 (42)	58.3 (63)	79.5 (79.5)	50 ‡	40	20G1ANE053ANONNNNN	50 (46)	55 (69)	75 (82.8)	45	37	20G1ANF050JN0NNNNN	6 ♣
63 (52)	69.3 (78)	94.5 (94.5)	60	50	20G1ANE063ANONNNNN	61 (50)	67.1 (75)	91.5 (91.5)	55	45	20G1ANF061JN0NNNNN	6 ♣
77 (63)	84.7 (94.5)	116 (116)	75	60	20G1ANE077ANONNNNN	82 (61)	90.2 (91.5)	123 (123)	75	55	20G1ANF082JN0NNNNN	6 ♣
99 (77)	109 (116)	149 (149)	100	75	20G1ANE099ANONNNNN	98 (82)	108 (123)	147 (148)	90	75	20G1ANF098JN0NNNNN	6 ♣
125 (99)	138 (149)	188 (188)	125	100	20G1ANE125ANONNNNN	119 (98)	131 (147)	179 (179)	110	90	20G1ANF119JN0NNNNN	6 ♣
144 (125)	158 (188)	216 (225)	150	125	20G1ANE144ANONNNNN	142 (119)	156 (179)	213 (214)	132	110	20G1ANF142JN0NNNNN	6 ♣
192 (144)	211 (216)	288 (288)	200	150	20G1ANE192ANONNNNN	171 (142)	188 (213)	257 (257)	160	132	20G1ANF171JN0NNNNN	7 ♣
242 (192)	266 (288)	363 (363)	250	200	20G1ANE242ANONNNNN	212 (171)	233 (257)	318 (318)	200	160	20G1ANF212JN0NNNNN	7 ♣
289 (242)	318 (318)	434 (436)	300	250	20G1ANE289ANONNNNN	263 (212)	289 (289)	395 (395)	250	200	20G1ANF263JN0NNNNN	7 ♣

★ The 11th character determines default Filtering and Common Mode Cap jumper configuration. "J" = Installed, "A" = Removed.

‡ Alternate 600V ratings when connected to drives 60 Hp and greater in common DC input applications with uncontrolled front ends.

§ These drives have dual current ratings; one for normal duty applications, and one for heavy duty applications (in parenthesis). The drive may be operated at either rating.

♣ Also available with internal Brake IGBT (20G1xxxxxxx A xxxxxx).



Flange Mount

Front = IP20, NEMA/UL Type Open, Back/Heatsink = IP66, NEMA/UL Type 4X

380...480V AC, Three-Phase Drives

480V AC Input					400V AC Input						Frame Size	
Output Amps §			Normal Duty Hp	Heavy Duty Hp	Cat. No.	Output Amps §			Normal Duty kW	Heavy Duty kW		Cat. No. ★
Cont.	1 Min.	3 Sec.				Cont.	1 Min.	3 Sec.				
2.1	3.1	3.7	1	1	20G11FD2P1AA0NNNNN	2.1	3.1	3.7	0.75	0.75	20G11FC2P1JA0NNNNN	2
3.4	5.1	6.1	2	2	20G11FD3P4AA0NNNNN	3.5	5.2	6.3	1.5	1.5	20G11FC3P5JA0NNNNN	2
5	7.5	9	3	3	20G11FD5P0AA0NNNNN	5	7.5	9.0	2.2	2.2	20G11FC5P0JA0NNNNN	2
8	12	14.4	5	5	20G11FD8P0AA0NNNNN	8.7	13	15.6	4	4	20G11FC8P7JA0NNNNN	2
11	16.5	19.8	7.5	7.5	20G11FD011AA0NNNNN	11.5	17.2	20.7	5.5	5.5	20G11FC011JA0NNNNN	2
14 (11)	15.4 (16.5)	21 (21)	10	7.5	20G11FD014AA0NNNNN	15.4 (11.5)	16.9 (17.3)	23.1 (23.1)	7.5	5.5	20G11FC015JA0NNNNN	2
22 (14)	24.2 (21)	33 (33)	15	10	20G11FD022AA0NNNNN	22 (15.4)	24.2 (23.1)	33 (33)	11	7.5	20G11FC022JA0NNNNN	2
27 (22)	29.7 (33)	40.5 (40.5)	20	15	20G11FD027AA0NNNNN	30 (22)	33 (33)	45 (45)	15	11	20G11FC030JA0NNNNN	3
34 (27)	37.4 (40.5)	51 (51)	25	20	20G11FD034AA0NNNNN	37 (30)	40.7 (45)	55.5 (55.5)	18.5	15	20G11FC037JA0NNNNN	3
40 (34)	44 (51)	60 (61.2)	30	25	20G11FD040AA0NNNNN	43 (37)	47.3 (55.5)	64.5 (66.6)	22	18.5	20G11FC043JA0NNNNN	3
52 (40)	57.2 (60)	78 (78)	40	30	20G11FD052AA0NNNNN	60 (43)	66 (66)	90 (90)	30	22	20G11FC060JA0NNNNN	4
65 (52)	71.5 (78)	97.5 (97.5)	50	40	20G11FD065AA0NNNNN	72 (60)	79.2 (90)	108 (108)	37	30	20G11FC072JA0NNNNN	4
77 (65)	84.7 (97.5)	116 (117)	60	50	20G11FD077AA0NNNNN	85 (72)	93.5 (108)	128 (130)	45	37	20G11FC085JA0NNNNN	5
96 (77)	106 (116)	144 (144)	75	60	20G11FD096AA0NNNNN	104 (85)	114 (128)	156 (156)	55	45	20G11FC104JA0NNNNN	5

Note: Frames 6...7 require an optional user installed flange kit with an IP00, NEMA/UL Type Open drive.

★ The 11th character determines default Filtering and Common Mode Cap jumper configuration. "J" = Installed, "A" = Removed.

§ Some drives have dual current ratings; one for normal duty applications, and one for heavy duty applications (in parenthesis). The drive may be operated at either rating.

600V AC, Three-Phase Drives

Output Amps §			Normal Duty Hp	Heavy Duty Hp	Cat. No.	Frame Size
Cont.	1 Min.	3 Sec.				
1.7 (0.9)	1.9 (1.4)	2.6 (2.6)	1	0.5	20G11FE1P7AA0NNNNN	3
2.7 (1.7)	3.0 (2.6)	4.1 (4.6)	2	1	20G11FE2P7AA0NNNNN	3
3.9 (2.7)	4.3 (4.1)	5.9 (7.3)	3	2	20G11FE3P9AA0NNNNN	3
6.1 (3.9)	6.7 (5.9)	9.2 (10.5)	5	3	20G11FE6P1AA0NNNNN	3
9 (6.1)	9.9 (9.2)	13.5 (16.5)	7.5	5	20G11FE9P0AA0NNNNN	3
11 (9)	12.1 (13.5)	16.5 (24.3)	10	7.5	20G11FE011AA0NNNNN	3
17 (11)	18.7 (16.5)	25.5 (29.7)	15	10	20G11FE017AA0NNNNN	3
22 (17)	24 (26)	33 (46)	20	15	20G11FE022AA0NNNNN	3
27 (22)	30 (33)	41 (59)	25	20	20G11FE027AA0NNNNN	4
32 (27)	35 (41)	48 (73)	30	25	20G11FE032AA0NNNNN	4
41 (32)	45 (48)	62 (86)	40	30	20G11FE041AA0NNNNN	5
52 (41)	57 (62)	78 (111)	50	40	20G11FE052AA0NNNNN	5

§ These drives have dual current ratings; one for normal duty applications, and one for heavy duty applications (in parenthesis). The drive may be operated at either rating.

## IP54, NEMA/UL Type 12

## 380...480V AC, Three-Phase Drives

480V AC Input						400V AC Input						Frame Size
Output Amps §			Normal Duty Hp	Heavy Duty Hp	Cat. No.	Output Amps §			Normal Duty kW	Heavy Duty kW	Cat. No. ★	
Cont.	1 Min.	3 Sec.				Cont.	1 Min.	3 Sec.				
2.1	3.1	3.7	1	1	20G11GD2P1AA0NNNNN	2.1	3.1	3.7	0.75	0.75	20G11GC2P1JA0NNNNN	2
3.4	5.1	6.1	2	2	20G11GD3P4AA0NNNNN	3.5	5.2	6.3	1.5	1.5	20G11GC3P5JA0NNNNN	2
5	7.5	9	3	3	20G11GD5P0AA0NNNNN	5	7.5	9.0	2.2	2.2	20G11GC5P0JA0NNNNN	2
8	12	14.4	5	5	20G11GD8P0AA0NNNNN	8.7	13	15.6	4	4	20G11GC8P7JA0NNNNN	2
11	16.5	19.8	7.5	7.5	20G11GD011AA0NNNNN	11.5	17.2	20.7	5.5	5.5	20G11GC011JA0NNNNN	2
14 (11)	15.4 (16.5)	21 (21)	10	7.5	20G11GD014AA0NNNNN	15.4 (11.5)	16.9 (17.3)	23.1 (23.1)	7.5	5.5	20G11GC015JA0NNNNN	2
22 (14)	24.2 (21)	33 (33)	15	10	20G11GD022AA0NNNNN	22 (15.4)	24.2 (23.1)	33 (33)	11	7.5	20G11GC022JA0NNNNN	2
27 (22)	29.7 (33)	40.5 (40.5)	20	15	20G11GD027AA0NNNNN	30 (22)	33 (33)	45 (45)	15	11	20G11GC030JA0NNNNN	3
34 (27)	37.4 (40.5)	51 (51)	25	20	20G11GD034AA0NNNNN	37 (30)	40.7 (45)	55.5 (55.5)	18.5	15	20G11GC037JA0NNNNN	3
40 (34)	44 (51)	60 (61.2)	30	25	20G11GD040AA0NNNNN	43 (37)	47.3 (55.5)	64.5 (66.6)	22	18.5	20G11GC043JA0NNNNN	3
52 (40)	57.2 (60)	78 (78)	40	30	20G11GD052AA0NNNNN	60 (43)	66 (66)	90 (90)	30	22	20G11GC060JA0NNNNN	4
65 (52)	71.5 (78)	97.5 (97.5)	50	40	20G11GD065AA0NNNNN	72 (60)	79.2 (90)	108 (108)	37	30	20G11GC072JA0NNNNN	5
77 (65)	84.7 (97.5)	116 (117)	60	50	20G11GD077AA0NNNNN	85 (72)	93.5 (108)	128 (130)	45	37	20G11GC085JA0NNNNN	5
96 (77)	106 (116)	144 (144)	75	60	20G1AGD096AN0NNNNN	104 (85)	114 (128)	156 (156)	55	45	20G1AGC104JN0NNNNN	6 ♣
125 (96)	138 (144)	188 (188)	100	75	20G1AGD125AN0NNNNN	140 (104)	154 (156)	210 (210)	75	55	20G1AGC140JN0NNNNN	6 ♣
156 (125)	172 (188)	234 (234)	125	100	20G1AGD156AN0NNNNN	170 (140)	187 (210)	255 (255)	90	75	20G1AGC170JN0NNNNN	6 ♣
186 (156)	205 (234)	279 (281)	150	125	20G1AGD186AN0NNNNN	205 (170)	226 (255)	308 (308)	110	90	20G1AGC205JN0NNNNN	6 ♣
248 (186)	273 (279)	372 (372)	200	150	20G1AGD248AN0NNNNN	260 (205)	286 (308)	390 (390)	132	110	20G1AGC260JN0NNNNN	7 ♣
302 (248)	332 (372)	453 (453)	250	200	20G1AGD302AN0NNNNN	302 (260)	332 (390)	453 (468)	160	132	20G1AGC302JN0NNNNN	7 ♣
361 (302)	397 (453)	542 (544)	300	250	20G1AGD361AN0NNNNN	367 (302)	404 (453)	551 (551)	200	160	20G1AGC367JN0NNNNN	7 ♣
415 (361)	457 (542)	623 (650)	350	300	20G1AGD415AN0NNNNN	456 (367)	502 (551)	684 (684)	250	200	20G1AGC456JN0NNNNN	7 ♣

★ The 11th character determines default Filtering and Common Mode Cap jumper configuration. "J" = Installed, "A" = Removed.

♣ Also available with internal Brake IGBT (20G1xxxxxx A xxxxxx).

§ Some drives have dual current ratings; one for normal duty applications, and one for heavy duty applications (in parenthesis). The drive may be operated at either rating.

### IP54, NEMA/UL Type 12 (continued)

Frames 3, 4 and 5 are 600V only drives. Frames 6 and 7 are dual voltage drives and can be operated at 600V or 690V AC.

**Important:** Frames 3, 4, and 5 must NOT be used in common DC input sharing applications with Frame 6 or larger drives. For details, contact your local Rockwell Automation sales office or Allen-Bradley Distributor.

DC Bus terminals are not supplied with AC input Frame 6 and 7 drives.

#### 600V AC, Three-Phase Drives

Cont.	Output Amps §		Normal Duty Hp	Heavy Duty Hp	Cat. No.	Frame Size
	1 Min.	3 Sec.				
1.7 (0.9)	1.9 (1.4)	2.6 (2.6)	1	0.5	20G11GE1P7AA0NNNNN	3
2.7 (1.7)	3.0 (2.6)	4.1 (4.6)	2	1	20G11GE2P7AA0NNNNN	3
3.9 (2.7)	4.3 (4.1)	5.9 (7.3)	3	2	20G11GE3P9AA0NNNNN	3
6.1 (3.9)	6.7 (5.9)	9.2 (10.5)	5	3	20G11GE6P1AA0NNNNN	3
9 (6.1)	9.9 (9.2)	13.5 (16.5)	7.5	5	20G11GE9P0AA0NNNNN	3
11 (9)	12.1 (13.5)	16.5 (24.3)	10	7.5	20G11GE011AA0NNNNN	3
17 (11)	18.7 (16.5)	25.5 (29.7)	15	10	20G11GE017AA0NNNNN	3
22 (17)	24 (26)	33 (46)	20	15	20G11GE022AA0NNNNN	3
27 (22)	30 (33)	41 (59)	25	20	20G11GE027AA0NNNNN	4
32 (27)	35 (41)	48 (73)	30	25	20G11GE032AA0NNNNN	4
41 (32)	45 (48)	62 (86)	40	30	20G11GE041AA0NNNNN	5
52 (41)	57 (62)	78 (111)	50	40	20G11GE052AA0NNNNN	5

§ These drives have dual current ratings; one for normal duty applications, and one for heavy duty applications (in parenthesis). The drive may be operated at either rating.

#### 600...690V AC, Three-Phase Drives

600V AC Input					690V AC Input						Frame Size	
Output Amps §			Normal Duty Hp	Heavy Duty Hp	Cat. No.	Output Amps §			Normal Duty kW	Heavy Duty kW		Cat. No. ★
Cont.	1 Min.	3 Sec.				Cont.	1 Min.	3 Sec.				
12 (9.1)	13.2 (13.7)	18 (18)	10 ‡	7.5	20G1AGE012ANONNNNN	12 (9)	13.2 (13.5)	18 (18)	7.5	5.5	20G1AGF012JNONNNNN	6 ♣
18 (11.1)	19.8 (16.7)	27 (27)	15 ‡	10	20G1AGE018ANONNNNN	15 (11.5)	16.5 (17.3)	22.5 (22.5)	11	7.5	20G1AGF015JNONNNNN	6 ♣
23 (18)	25.3 (27)	34.5 (34.5)	20 ‡	15	20G1AGE023ANONNNNN	20 (15)	22 (22.5)	30 (30)	15	11	20G1AGF020JNONNNNN	6 ♣
24 (22)	26.4 (33)	36 (39.6)	20 ‡	20	20G1AGE024ANONNNNN	23 (20)	25.3 (30)	34.5 (36)	18.5	15	20G1AGF023JNONNNNN	6 ♣
28 (23)	30.8 (34.5)	42 (42)	25 ‡	20	20G1AGE028ANONNNNN	30 (23)	33 (34.5)	45 (45)	22	18.5	20G1AGF030JNONNNNN	6 ♣
33 (28)	36.3 (42)	49.5 (50.4)	30 ‡	25	20G1AGE033ANONNNNN	34 (30)	37.4 (45)	51 (54)	30	22	20G1AGF034JNONNNNN	6 ♣
42 (33)	46.2 (49.5)	63 (63)	40 ‡	30	20G1AGE042ANONNNNN	46 (34)	50.6 (51)	69 (69)	37	30	20G1AGF046JNONNNNN	6 ♣
53 (42)	58.3 (63)	79.5 (79.5)	50 ‡	40	20G1AGE053ANONNNNN	50 (46)	55 (69)	75 (82.8)	45	37	20G1AGF050JNONNNNN	6 ♣
63 (52)	69.3 (78)	94.5 (94.5)	60	50	20G1AGE063ANONNNNN	61 (50)	67.1 (75)	91.5 (91.5)	55	45	20G1AGF061JNONNNNN	6 ♣
77 (63)	84.7 (94.5)	116 (116)	75	60	20G1AGE077ANONNNNN	82 (61)	90.2 (91.5)	123 (123)	75	55	20G1AGF082JNONNNNN	6 ♣
99 (77)	109 (116)	149 (149)	100	75	20G1AGE099ANONNNNN	98 (82)	108 (123)	147 (148)	90	75	20G1AGF098JNONNNNN	6 ♣
125 (99)	138 (149)	188 (188)	125	100	20G1AGE125ANONNNNN	119 (98)	131 (147)	179 (179)	110	90	20G1AGF119JNONNNNN	6 ♣
144 (125)	158 (188)	216 (225)	150	125	20G1AGE144ANONNNNN	142 (119)	156 (179)	213 (214)	132	110	20G1AGF142JNONNNNN	6 ♣
192 (144)	211 (216)	288 (288)	200	150	20G1AGE192ANONNNNN	171 (142)	188 (213)	257 (257)	160	132	20G1AGF171JNONNNNN	7 ♣
242 (192)	266 (288)	363 (363)	250	200	20G1AGE242ANONNNNN	212 (171)	233 (257)	318 (318)	200	160	20G1AGF212JNONNNNN	7 ♣
289 (242)	318 (318)	434 (436)	300	250	20G1AGE289ANONNNNN	263 (212)	289 (289)	395 (395)	250	200	20G1AGF263JNONNNNN	7 ♣

★ The 11th character determines default Filtering and Common Mode Cap jumper configuration. "J" = Installed, "A" = Removed.

‡ Alternate 600V ratings when connected to drives 60 Hp and greater in common DC input applications with uncontrolled front ends.

§ These drives have dual current ratings; one for normal duty applications, and one for heavy duty applications (in parenthesis). The drive may be operated at either rating.

♣ Also available with internal Brake IGBT (20G1xxxxxxx A xxxxxx).

## PowerFlex 755 Floor Mount Drives

PowerFlex 755 floor mount drives have a power range of 200 kW / 250 Hp to 1400 kW / 2000 Hp and offer multiple duty ratings to allow a drive to provide flexibility for different application requirements. One drive can provide three different motor current ratings. For example a 430 A drive can run a 400 Hp motor in light duty, a 350 Hp motor in normal duty and 300 Hp motor in heavy duty.

- Light Duty = 110% of motor rated current for 60 seconds
- Normal Duty = 110% of motor rated current for 60 seconds/150% of motor rated current for 3 seconds
- Heavy Duty = 150% of motor rated current for 60 seconds/180% of motor rated current for 3 seconds



Frame 8



Frame 9



Frame 10

### IP20, NEMA/UL Type 1 Drive (2500 MCC Style Cabinet)

Includes: DC link choke, Integrated AC line fuses and Roll-out design.  
Hood shown on top of cabinets is optional, refer to page 120 for ordering information.



**IP54, NEMA Type 12 Drive and Options (2500 MCC Style Cabinet)**  
(Frame 9 shown)

Includes: DC link choke, Integrated AC line fuses, Roll-out design, Exhaust Hood, and Option bay for control/protection devices.



**Roll-out Design**  
(Frame 8 shown)

A Roll-out Cart is required for Frame 8 . . . 10 drives and Frame 9 . . . 10 Option Bay Chassis. The cart has an adjustable Curb Height of 0 . . . 182 mm (0 . . . 7.2 in.) and Curb Offset/Reach of 0 . . . 114 mm (0 . . . 4.5 in.). See page 121 for ordering information.

## 2500 MCC Style Cabinets

Drives listed on the following pages utilize a CENTERLINE® 2500 MCC style cabinet. This term refers to the type of cabinet and does not imply that the MCC bus is included. To add an MCC bus, refer to pages 108...109 and choose option P20, P22 or P24.

### Power Wiring Options

The following table describes the cabling options available for each Frame 8...10 drive enclosure. Refer to the PowerFlex 750-Series Technical Data, publication 750-TD001 for conduit plate dimensions.

<div style="background-color: #cccccc; width: 40px; height: 15px; margin: 0 auto;"></div> <p><b>Adequate Spacing</b> Available conduit plates provide adequate spacing for typical cabling.</p>	<div style="background-color: #cccccc; width: 40px; height: 15px; margin: 0 auto;"></div> <p><b>0</b></p> <p><b>Possible – Evaluation is Required</b> Available conduit plates must be evaluated to determine if cabling will fit.</p>	<div style="background-color: #cccccc; width: 40px; height: 15px; margin: 0 auto;"></div> <p><b>X</b></p> <p><b>Not Possible – Insufficient Spacing</b> Conduit plates are not available for the specified configuration.</p>
---	--	---

Frame	Enclosure Rating	Enclosure Code	Cabinet Layout	Top Entry/ Top Exit	Top Entry/ Bottom Exit	Bottom Entry/ Top Exit	Bottom Entry/ Bottom Exit
8	IP20, NEMA/UL Type 1	B	600 mm Drive Cabinet	X		X	0
		L, P, W	800 mm Drive Cabinet	0		0	
		B	600 mm Drive with Power Option Bay			X	0
		L, P, W	800 mm Drive with Power Option Bay			0	
		B	600 mm Drive with Wiring Bay				
		L, P, W	800 mm Drive with Wiring Bay				
		B	600 mm Drive with Power Option and Wiring Bays				
		L, P, W	800 mm Drive with Power Option Bay and Wiring Bays				
	IP54, NEMA 12	J, K, Y	800 mm Drive Cabinet	X	X	X	
		J, K, Y	800 mm Drive with Power Option Bay	X		0	0
		J, K, Y	800 mm Drive with Wiring Bay				
		J, K, Y	800 mm Drive with Power Option Bay and Wiring Bays				
9	IP20, NEMA/UL Type 1	B	600 mm Drive Cabinet	0		0	0
		L, P, W	800 mm Drive Cabinet				
		B	600 mm Drive with Power Option Bay			X	
		L, P, W	800 mm Drive with Power Option Bay			0	
		B	600 mm Drive with Wiring Bay				
		L, P, W	800 mm Drive with Wiring Bay				
		B	600 mm Drive with Power Option and Wiring Bays				
		L, P, W	800 mm Drive with Power Option Bay and Wiring Bays				
	IP54, NEMA 12	J, K, Y	800 mm Drive Cabinet	X	X	X	
		J, K, Y	800 mm Drive with Power Option Bay	0		0	
		J, K, Y	800 mm Drive with Wiring Bay				
		J, K, Y	800 mm Drive with Power Option Bay and Wiring Bays				
10	IP20, NEMA/UL Type 1	B	600 mm Drive Cabinet	0		0	0
		L, P, W	800 mm Drive Cabinet			0	
		B	600 mm Drive with Power Option Bay	X		X	
		L, P, W	800 mm Drive with Power Option Bay	0		0	
		B	600 mm Drive with Wiring Bay				
		L, P, W	800 mm Drive with Wiring Bay				
		B	600 mm Drive with Power Option and Wiring Bays				
		L, P, W	800 mm Drive with Power Option Bay and Wiring Bays			X	
	IP54, NEMA 12	J, K, Y	800 mm Drive Cabinet	X	X	X	
		J, K, Y	800 mm Drive with Power Option Bay	X	0	0	
		J, K, Y	800 mm Drive with Wiring Bay	0			
		J, K, Y	800 mm Drive with Power Option Bay and Wiring Bays				

## IP20, NEMA/UL Type 1 (2500 MCC Style Cabinet)

## 380...400V AC, Three-Phase and 540V DC Input Drives ▽

Light Duty				Normal Duty				Heavy Duty				Cat. No. ★ §	Frame Size
Output Amps			kW	Output Amps			kW	Output Amps			kW		
Cont.	1 Min.	3 Sec.		Cont.	1 Min.	3 Sec.		Cont.	1 Min.	3 Sec.			
540	594	NA	315	460	506	693	250	385	578	693	200	20G1A+C460JNONNNNN	8
585	644		315	540	594	821	315	456	684	821	250	20G1A+C540JNONNNNN	8
612	673		355	567	624	851	315	472	708	851	250	20G1A+C567JNONNNNN	8
750	825		400	650	715	975	355	540	810	975	315	20G1A+C650JNONNNNN	8
796	876		450	750	825	1125	400	585	878	1125	315	20G1A+C750JNONNNNN	8
832	915		450	770	847	1155	400	642	963	1155	355	20G1A+C770JNONNNNN	8
1040	1144		560	910	1001	1365	500	750	1125	1365	400	20G11+C910JNONNNNN	9
1090	1199		630	1040	1144	1584	560	880	1320	1584	500	20G11+C1K0JNONNNNN	9
1175	1293		710	1090	1199	1638	630	910	1365	1638	500	20G11+C1K1JNONNNNN	9
1465	1612		800	1175	1293	1872	710	1040	1560	1872	560	20G11+C1K2JNONNNNN	9
1480	1628		850	1465	1612	2198	800	1090	1635	2198	630	20G11+C1K4JNONNNNN	9
1600	1760		900	1480	1628	2220	850	1175	1763	2220	710	20G11+C1K5JNONNNNN	9
1715	1887		1000	1590	1749	2385	900	1325	1988	2385	710	20G11+C1K6JNONNNNN	10
2330	2563		1400	2150	2365	3225	1250	1800	2700	3225	1000	20G11+C2K1JNONNNNN	10

§ The 5th character determines Input Type. "1" = AC and DC input with precharge. "4" = DC input with precharge. "A" = AC input with precharge and no DC terminals.

‡ The 6th character determines Enclosure Type and Depth. "B" = IP20, NEMA/UL Type 1, MCC style 600 mm (23.6 in.) deep. "L" = IP20, NEMA/UL Type 1, MCC style 800 mm (31.5 in.) deep. Refer to Power Wiring Options on page 98.

★ The 11th character determines default Filtering and Common Mode Cap jumper configuration. "J" = Installed, "A" = Removed.

▽ A Roll-out Cart is required with Frame 8...10 drives to assist with power wiring and cabinet mounting. Refer to page 121.

## 480V AC, Three-Phase and 650V DC Input Drives ▽

Light Duty				Normal Duty				Heavy Duty				Cat. No. §	Frame Size
Output Amps			Hp	Output Amps			Hp	Output Amps			Hp		
Cont.	1 Min.	3 Sec.		Cont.	1 Min.	3 Sec.		Cont.	1 Min.	3 Sec.			
485	534	NA	400	430	473	666	350	370	555	666	300	20G1A+D430ANONNNNN	8
545	600		450	485	534	745	400	414	621	745	350	20G1A+D485ANONNNNN	8
590	649		500	545	600	818	450	454	681	818	350	20G1A+D545ANONNNNN	8
710	781		600	617	679	926	500	485	728	926	400	20G1A+D617ANONNNNN	8
765	842		650	710	781	1065	600	545	818	1065	450	20G1A+D710ANONNNNN	8
800	880		700	740	817	1110	650	617	926	1110	500	20G1A+D740ANONNNNN	8
960	1056		800	800	880	1278	700	710	1065	1278	600	20G11+D800ANONNNNN	9
1045	1150		900	960	1056	1440	800	795	1193	1440	700	20G11+D960ANONNNNN	9
1135	1249		1000	1045	1150	1568	900	800	1200	1568	750	20G11+D1K0ANONNNNN	9
1365	1502		1100	1135	1249	1728	1000	960	1440	1728	800	20G11+D1K2ANONNNNN	9
1420	1562		1250	1365	1502	2048	1100	1045	1568	2048	900	20G11+D1K3ANONNNNN	9
1540	1694		1350	1420	1562	2130	1250	1135	1703	2130	1000	20G11+D1K4ANONNNNN	9
1655	1821		1500	1525	1678	2288	1350	1270	1905	2288	1100	20G11+D1K5JNONNNNN	10
2240	2464		2000	2070	2277	3105	1750	1730	2595	3105	1650	20G11+D2K0JNONNNNN	10

§ The 5th character determines Input Type. "1" = AC and DC input with precharge. "4" = DC input with precharge. "A" = AC input with precharge and no DC terminals.

‡ The 6th character determines Enclosure Type and Depth. "B" = IP20, NEMA/UL Type 1, MCC style 600 mm (23.6 in.) deep. "L" = IP20, NEMA/UL Type 1, MCC style 800 mm (31.5 in.) deep. Refer to Power Wiring Options on page 98.

▽ A Roll-out Cart is required with Frame 8...10 drives to assist with power wiring and cabinet mounting, page 121.



IP20, NEMA/UL Type 1 (continued)

600V AC, Three-Phase and 810V DC Input Drives ▾

Light Duty				Normal Duty				Heavy Duty				Cat. No. §	Frame Size
Output Amps			Hp	Output Amps			Hp	Output Amps			Hp		
Cont.	1 Min.	3 Sec.		Cont.	1 Min.	3 Sec.		Cont.	1 Min.	3 Sec.			
355	391	NA	350	295	325	490	300	272	408	490	250	20G1A#E295ANONNNNNN	8
395	435		400	355	391	533	350	295	443	533	300	20G1A#E355ANONNNNNN	8
435	479		450	395	435	593	400	329	494	593	350	20G1A#E395ANONNNNNN	8
460	506		500	435	479	639	450	355	533	639	350	20G1A#E435ANONNNNNN	8
510	561		500	460	506	711	500	395	593	711	400	20G1A#E460ANONNNNNN	8
545	600		550	510	561	765	500	425	638	765	450	20G1A#E510ANONNNNNN	8
690	759		700	595	655	918	600	510	765	918	500	20G11#E595ANONNNNNN	9
760	836		800	630	693	1071	700	595	893	1071	600	20G11#E630ANONNNNNN	9
835	919		900	760	836	1140	800	630	945	1140	700	20G11#E760ANONNNNNN	9
900	990		950	825	908	1260	900	700	1050	1260	750	20G11#E825ANONNNNNN	9
980	1078		1000	900	990	1368	950	760	1140	1368	800	20G11#E900ANONNNNNN	9
1045	1150		1100	980	1078	1470	1000	815	1223	1470	900	20G11#E980ANONNNNNN	9
1220	1342		1200	1110	1221	1665	1100	920	1380	1665	1000	20G11#E1K1ANONNNNNN	10
1530	1683		1500	1430	1573	2145	1400	1190	1785	2145	1250	20G11#E1K4ANONNNNNN	10

§ The 5th character determines Input Type. "1" = AC and DC input with precharge. "4" = DC input with precharge. "A" = AC input with precharge and no DC terminals.  
 ‡ The 6th character determines Enclosure Type and Depth. "B" = IP20, NEMA/UL Type 1, MCC style 600 mm (23.6 in.) deep. "L" = IP20, NEMA/UL Type 1, MCC style 800 mm (31.5 in.) deep. Refer to Power Wiring Options on page 98.  
 ▾ A Roll-out Cart is required with Frame 8...10 drives to assist with power wiring and cabinet mounting. Refer to page 121.

690V AC, Three-Phase and 932V DC Input Drives ▾

Light Duty				Normal Duty				Heavy Duty				Cat. No. § ★	Frame Size
Output Amps			kW	Output Amps			kW	Output Amps			kW		
Cont.	1 Min.	3 Sec.		Cont.	1 Min.	3 Sec.		Cont.	1 Min.	3 Sec.			
330	363	NA	315	265	292	375	250	215	323	375	200	20G1A#F265ANONNNNNN	8
370	407		355	330	363	473	315	265	398	473	250	20G1A#F330ANONNNNNN	8
410	451		400	370	407	555	355	308	462	555	300	20G1A#F370ANONNNNNN	8
460	506		450	415	457	639	400	370	555	639	355	20G1A#F415ANONNNNNN	8
500	550		500	460	506	675	450	375	563	675	375	20G1A#F460ANONNNNNN	8
530	583		530	500	550	750	500	413	620	750	400	20G1A#F500ANONNNNNN	8
650	715		630	590	649	885	560	460	690	885	450	20G11#F590ANONNNNNN	9
710	781		710	650	715	975	630	500	750	975	500	20G11#F650ANONNNNNN	9
790	869		800	710	781	1065	710	590	885	1065	560	20G11#F710ANONNNNNN	9
860	946		850	765	842	1170	750	650	975	1170	630	20G11#F765ANONNNNNN	9
960	1056		900	795	875	1350	800	750	1125	1350	710	20G11#F795ANONNNNNN	9
1020	1122		1000	960	1056	1440	900	795	1193	1440	800	20G11#F960ANONNNNNN	9
1150	1265		1100	1040	1144	1560	1000	865	1298	1560	900	20G11#F1K0ANONNNNNN	10
1485	1634		1500	1400	1540	2100	1400	1160	1740	2100	1120	20G11#F1K4ANONNNNNN	10

§ The 5th character determines Input Type. "1" = AC and DC input with precharge. "4" = DC input with precharge. "A" = AC input with precharge and no DC terminals.  
 ‡ The 6th character determines Enclosure Type and Depth. "B" = IP20, NEMA/UL Type 1, MCC style 600 mm (23.6 in.) deep. "L" = IP20, NEMA/UL Type 1, MCC style 800 mm (31.5 in.) deep. Refer to Power Wiring Options on page 98.  
 ★ The 11th character determines default Filtering and Common Mode Cap jumper configuration. "J" = Installed, "A" = Removed.  
 ▾ A Roll-out Cart is required with Frame 8...10 drives to assist with power wiring and cabinet mounting. Refer to page 121.

## IP54, NEMA Type 12 (2500 MCC Style Cabinet)

## 380...400V AC, Three-Phase and 540V DC Input Drives ▽

Light Duty				Normal Duty				Heavy Duty				Cat. No. ★	Frame Size
Output Amps			kW	Output Amps			kW	Output Amps			kW		
Cont.	1 Min.	3 Sec.		Cont.	1 Min.	3 Sec.		Cont.	1 Min.	3 Sec.			
540	594	NA	315	460	506	693	250	385	578	693	200	20G1AJC460ANONNNNNN	8
585	644		315	540	594	821	315	456	684	821	250	20G1AJC540ANONNNNNN	8
612	673		355	567	624	851	315	472	708	851	250	20G1AJC567ANONNNNNN	8
750	825		400	650	715	975	355	540	810	975	315	20G1AJC650ANONNNNNN	8
796	876		450	750	825	1125	400	585	878	1125	315	20G1AJC750ANONNNNNN	8
832	915		450	770	847	1155	400	642	963	1155	355	20G1AJC770ANONNNNNN	8
1040	1144		560	910	1001	1365	500	750	1125	1365	400	20G11JC910ANONNNNNN	9
1090	1199		630	1040	1144	1584	560	880	1320	1584	500	20G11JC1K0ANONNNNNN	9
1175	1293		710	1090	1199	1638	630	910	1365	1638	500	20G11JC1K1ANONNNNNN	9
1465	1612		800	1175	1293	1872	710	1040	1560	1872	560	20G11JC1K2ANONNNNNN	9
1480	1628		850	1465	1612	2198	800	1090	1635	2198	630	20G11JC1K4ANONNNNNN	9
1600	1760		900	1480	1628	2220	850	1175	1763	2220	710	20G11JC1K5ANONNNNNN	9
1715	1887		1000	1590	1749	2385	900	1325	1988	2385	710	20G11JC1K6ANONNNNNN	10
2330	2563		1400	2150	2365	3225	1250	1800	2700	3225	1000	20G11JC2K1ANONNNNNN	10

★ The 11th character determines default Filtering and Common Mode Cap jumper configuration. "J" = Installed, "A" = Removed.

▽ A Roll-out Cart is required with Frame 8...10 drives to assist with power wiring and cabinet mounting. Refer to page 121.

## 480V AC, Three-Phase and 650V DC Input Drives ▽

Light Duty				Normal Duty				Heavy Duty				Cat. No.	Frame Size
Output Amps			Hp	Output Amps			Hp	Output Amps			Hp		
Cont.	1 Min.	3 Sec.		Cont.	1 Min.	3 Sec.		Cont.	1 Min.	3 Sec.			
485	534	NA	400	430	473	666	350	370	555	666	300	20G1AJD430ANONNNNNN	8
545	600		450	485	534	745	400	414	621	745	350	20G1AJD485ANONNNNNN	8
590	649		500	545	600	818	450	454	681	818	350	20G1AJD545ANONNNNNN	8
710	781		600	617	679	926	500	485	728	926	400	20G1AJD617ANONNNNNN	8
765	842		650	710	781	1065	600	545	818	1065	450	20G1AJD710ANONNNNNN	8
800	880		700	740	817	1110	650	617	926	1110	500	20G1AJD740ANONNNNNN	8
960	1056		800	800	880	1278	700	710	1065	1278	600	20G11JD800ANONNNNNN	9
1045	1150		900	960	1056	1440	800	795	1193	1440	700	20G11JD960ANONNNNNN	9
1135	1249		1000	1045	1150	1568	900	800	1200	1568	750	20G11JD1K0ANONNNNNN	9
1365	1502		1100	1135	1249	1728	1000	960	1440	1728	800	20G11JD1K2ANONNNNNN	9
1420	1562		1250	1365	1502	2048	1100	1045	1568	2048	900	20G11JD1K3ANONNNNNN	9
1540	1694		1350	1420	1562	2130	1250	1135	1703	2130	1000	20G11JD1K4ANONNNNNN	9
1655	1821		1500	1525	1678	2288	1350	1270	1905	2288	1100	20G11JD1K5ANONNNNNN	10
2240	2464		2000	2070	2277	3105	1750	1730	2595	3105	1650	20G11JD2K0ANONNNNNN	10

▽ A Roll-out Cart is required with Frame 8...10 drives to assist with power wiring and cabinet mounting. Refer to page 121.

IP54, NEMA Type 12 (continued)

600V AC, Three-Phase and 810V DC Input Drives ▾

Light Duty				Normal Duty				Heavy Duty				Cat. No.	Frame Size
Output Amps			Hp	Output Amps			Hp	Output Amps			Hp		
Cont.	1 Min.	3 Sec.		Cont.	1 Min.	3 Sec.		Cont.	1 Min.	3 Sec.			
355	391	NA	350	295	325	490	300	272	408	490	250	20G1AJE295ANONNNNN	8
395	435		400	355	391	533	350	295	443	533	300	20G1AJE355ANONNNNN	8
435	479		450	395	435	593	400	329	494	593	350	20G1AJE395ANONNNNN	8
460	506		500	435	479	639	450	355	533	639	350	20G1AJE435ANONNNNN	8
510	561		500	460	506	711	500	395	593	711	400	20G1AJE460ANONNNNN	8
545	600		550	510	561	765	500	425	638	765	450	20G1AJE510ANONNNNN	8
690	759		700	595	655	918	600	510	765	918	500	20G11JE595ANONNNNN	9
760	836		800	630	693	1071	700	595	893	1071	600	20G11JE630ANONNNNN	9
835	919		900	760	836	1140	800	630	945	1140	700	20G11JE760ANONNNNN	9
900	990		950	825	908	1260	900	700	1050	1260	750	20G11JE825ANONNNNN	9
980	1078		1000	900	990	1368	950	760	1140	1368	800	20G11JE900ANONNNNN	9
1045	1150		1100	980	1078	1470	1000	815	1223	1470	900	20G11JE980ANONNNNN	9
1220	1342		1200	1110	1221	1665	1100	920	1380	1665	1000	20G11JE1K1ANONNNNN	10
1530	1683		1500	1430	1573	2145	1400	1190	1785	2145	1250	20G11JE1K4ANONNNNN	10

▾ A Roll-out Cart is required with Frame 8...10 drives to assist with power wiring and cabinet mounting. Refer to page 121.

690V AC, Three-Phase and 932V DC Input Drives ▾

Light Duty				Normal Duty				Heavy Duty				Cat. No. ★	Frame Size
Output Amps			kW	Output Amps			kW	Output Amps			kW		
Cont.	1 Min.	3 Sec.		Cont.	1 Min.	3 Sec.		Cont.	1 Min.	3 Sec.			
330	363	NA	315	265	292	375	250	215	323	375	200	20G1AJF265ANONNNNN	8
370	407		355	330	363	473	315	265	398	473	250	20G1AJF330ANONNNNN	8
410	451		400	370	407	555	355	308	462	555	300	20G1AJF370ANONNNNN	8
460	506		450	415	457	639	400	370	555	639	355	20G1AJF415ANONNNNN	8
500	550		500	460	506	675	450	375	563	675	375	20G1AJF460ANONNNNN	8
530	583		530	500	550	750	500	413	620	750	400	20G1AJF500ANONNNNN	8
650	715		630	590	649	885	560	460	690	885	450	20G11JF590ANONNNNN	9
710	781		710	650	715	975	630	500	750	975	500	20G11JF650ANONNNNN	9
790	869		800	710	781	1065	710	590	885	1065	560	20G11JF710ANONNNNN	9
860	946		850	765	842	1170	750	650	975	1170	630	20G11JF765ANONNNNN	9
960	1056		900	795	875	1350	800	750	1125	1350	710	20G11JF795ANONNNNN	9
1020	1122		1000	960	1056	1440	900	795	1193	1440	800	20G11JF960ANONNNNN	9
1150	1265		1100	1040	1144	1560	1000	865	1298	1560	900	20G11JF1K0ANONNNNN	10
1485	1634		1500	1400	1540	2100	1400	1160	1740	2100	1120	20G11JF1K4ANONNNNN	10

★ The 11th character determines default Filtering and Common Mode Cap jumper configuration. "J" = Installed, "A" = Removed.

▾ A Roll-out Cart is required with Frame 8...10 drives to assist with power wiring and cabinet mounting. Refer to page 121.

## IP00, NEMA Type Open

To order an IP00 drive:

1. Using the tables that follow, locate your desired drive output values.
2. Select the Base Drive Catalog Number for your desired output values.
3. Note the Quantity Required.
4. Order the specified quantity (1, 2, or 3) of the Base Drive Catalog Number.
5. Refer to the page 105 for option kits and the PowerFlex 755 IP00 NEMA/UL Open Type Drive Installation Instructions, publication 750-IN020 for installation details.

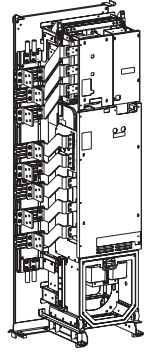

### 380...400V AC, Three-Phase and 540V DC Input Drives ▾

Light Duty		Normal Duty		Heavy Duty		Base Drive Cat. No. ★	Quantity Required	Equivalent Frame Size
Output Amps		Output Amps		Output Amps				
Cont.	kW	Cont.	kW	Cont.	kW			
540	315	460	250	385	200	20G11TC460ANONNNNN	1	8
585	315	540	315	456	250	20G11TC540ANONNNNN	1	8
612	355	567	315	472	250	20G11TC567ANONNNNN	1	8
750	400	650	355	540	315	20G11TC650ANONNNNN	1	8
796	450	750	400	585	315	20G11TC750ANONNNNN	1	8
832	450	770	400	642	355	20G11TC770ANONNNNN	1	8
1040	560	910	500	750	400	20G11TC460ANONNNNN	2	9
1090	630	1040	560	880	500	20G11TC540ANONNNNN	2	9
1175	710	1090	630	910	500	20G11TC567ANONNNNN	2	9
1465	800	1175	710	1040	560	20G11TC650ANONNNNN	2	9
1480	850	1465	800	1090	630	20G11TC750ANONNNNN	2	9
1600	900	1480	850	1175	710	20G11TC770ANONNNNN	2	9
1715	1000	1590	900	1325	710	20G11TC567ANONNNNN	3	10
2330	1400	2150	1250	1800	1000	20G11TC770ANONNNNN	3	10

★ The 11th character determines default Filtering and Common Mode Cap jumper configuration. "J" = Installed, "A" = Removed.

▾ A Roll-out Cart is required with Frame 8...10 drives to assist with power wiring and cabinet mounting. Refer to page 121.

### 480V AC, Three-Phase and 650V DC Input Drives ▾

Light Duty (-LD)		Normal Duty (-ND)		Heavy Duty (-HD)		Base Drive Cat. No.	Quantity Required	Equivalent Frame Size
Output Amps		Output Amps		Output Amps				
Cont.	Hp	Cont.	Hp	Cont.	Hp			
485	400	430	350	370	300	20G11TD430ANONNNNN	1	8
545	450	485	400	414	350	20G11TD485ANONNNNN	1	8
590	500	545	450	454	350	20G11TD545ANONNNNN	1	8
710	600	617	500	485	400	20G11TD617ANONNNNN	1	8
765	650	710	600	545	450	20G11TD710ANONNNNN	1	8
800	700	740	650	617	500	20G11TD740ANONNNNN	1	8
960	800	800	700	710	600	20G11TD430ANONNNNN	2	9
1045	900	960	800	795	700	20G11TD485ANONNNNN	2	9
1135	1000	1045	900	800	750	20G11TD545ANONNNNN	2	9
1365	1100	1135	1000	960	800	20G11TD617ANONNNNN	2	9
1420	1250	1365	1100	1045	900	20G11TD710ANONNNNN	2	9
1540	1350	1420	1250	1135	1000	20G11TD740ANONNNNN	2	9
1655	1500	1525	1350	1270	1100	20G11TD545ANONNNNN	3	10
2240	2000	2070	1750	1730	1650	20G11TD740ANONNNNN	3	10

▾ A Roll-out Cart is required with Frame 8...10 drives to assist with power wiring and cabinet mounting. Refer to page 121.

## IP00, NEMA Type Open (continued)

## 600V AC, Three-Phase and 810V DC Input Drives ▽

Light Duty (-LD)		Normal Duty (-ND)		Heavy Duty (-HD)		Base Drive Cat. No.	Quantity Required	Equivalent Frame Size
Output Amps		Output Amps		Output Amps				
Cont.	Hp	Cont.	Hp	Cont.	Hp			
355	350	295	300	272	250	20G11TE295ANONNNNN	1	8
395	400	355	350	295	300	20G11TE355ANONNNNN	1	8
435	450	395	400	329	350	20G11TE395ANONNNNN	1	8
460	500	435	450	355	350	20G11TE435ANONNNNN	1	8
510	500	460	500	395	400	20G11TE460ANONNNNN	1	8
545	550	510	500	425	450	20G11TE510ANONNNNN	1	8
690	700	595	600	510	500	20G11TE295ANONNNNN	2	9
760	800	630	700	595	600	20G11TE355ANONNNNN	2	9
835	900	760	800	630	700	20G11TE395ANONNNNN	2	9
900	950	825	900	700	750	20G11TE435ANONNNNN	2	9
980	1000	900	950	760	800	20G11TE460ANONNNNN	2	9
1045	1100	980	1000	815	900	20G11TE510ANONNNNN	2	9
1220	1200	1110	1100	920	1000	20G11TE395ANONNNNN	3	10
1530	1500	1430	1400	1190	1250	20G11TE510ANONNNNN	3	10

▽ A Roll-out Cart is required with Frame 8...10 drives to assist with power wiring and cabinet mounting. Refer to page 121.

## 690V AC, Three-Phase and 932V DC Input Drives ▽

Light Duty (-LD)		Normal Duty (-ND)		Heavy Duty (-HD)		Base Drive Cat. No. ★	Quantity Required	Equivalent Frame Size
Output Amps		Output Amps		Output Amps				
Cont.	KW	Cont.	KW	Cont.	KW			
330	315	265	250	215	200	20G11TF265ANONNNNN	1	8
370	355	330	315	265	250	20G11TF330ANONNNNN	1	8
410	400	370	355	308	300	20G11TF370ANONNNNN	1	8
460	450	415	400	370	355	20G11TF415ANONNNNN	1	8
500	500	460	450	375	375	20G11TF460ANONNNNN	1	8
530	530	500	500	413	400	20G11TF500ANONNNNN	1	8
650	630	590	560	460	450	20G11TF265ANONNNNN	2	9
710	710	650	630	500	500	20G11TF330ANONNNNN	2	9
790	800	710	710	590	560	20G11TF370ANONNNNN	2	9
860	850	765	750	650	630	20G11TF415ANONNNNN	2	9
960	900	795	800	750	710	20G11TF460ANONNNNN	2	9
1020	1000	960	900	795	800	20G11TF500ANONNNNN	2	9
1150	1100	1040	1000	865	900	20G11TF370ANONNNNN	3	10
1485	1500	1400	1400	1160	1120	20G11TF500ANONNNNN	3	10

★ The 11th character determines default Filtering and Common Mode Cap jumper configuration. "J" = Installed, "A" = Removed.

▽ A Roll-out Cart is required with Frame 8...10 drives to assist with power wiring and cabinet mounting. Refer to page 121.

## IP00, NEMA Type Open (continued)

## PowerFlex 755 IP00 Option Kits

Description	Required?	Frame 8		Frame 9		Frame 10	
		Cat. No.	Qty.	Cat. No.	Qty.	Cat. No.	Qty.
Field Termination, Converter, AC Input	Recommended	20-750-BUS2-F8	1	20-750-BUS2-F9	1	20-750-BUS2-F10	1
Field Termination, Inverter, AC Output	Recommended	20-750-BUS3-F8	1	20-750-BUS3-F9	1	20-750-BUS3-F10	1
Field Termination, Inverter, DC Bus	Recommended	20-750-BUS4-F8	1	20-750-BUS4-F9	1	20-750-BUS4-F10	1
Field Termination, DC Input, Common Bus Precharge § ♣	Recommended	20-750-BUS5-F8	1	20-750-BUS5-F9	1	20-750-BUS5-F10	1
POD, Bucket Assembly	Required	20-750-POD1-F8	1	20-750-POD1-F8	1	20-750-POD1-F8	1
POD, Cable, 24 Volt Supply ♦	Required	20-750-PH1-F8	△	20-750-PH2-F9	1	20-750-PH3-F10	1
Cable, Fiber Optic, 560 mm (22 in.) ♦	Required	20-750-FCBL1-F8	1	—	—	—	—
Cable, Fiber Optic, 2.8 m (110 in.) ♦	Required	—	—	20-750-FCBL1-F10	2	20-750-FCBL1-F10	3
Transceiver, Fiber Optic	Required	—	—	SK-R1-FTR1-F8	1	SK-R1-FTR1-F8	2
POD, Remote Mounting Kit	Optional	20-750-RPD1-F8	1	20-750-RPD1-F9	1	20-750-RPD1-F10	1
Mounting Kit, Back Panel	Recommended	20-750-MNT2-F8	1	20-750-MNT2-F9	1	20-750-MNT2-F10	1
Mounting Kit, Floor	Recommended	20-750-MNT3-F8	1	20-750-MNT3-F9	1	20-750-MNT3-F10	1
Duct, Top Outlet	Recommended	20-750-DUCT2-F8	1	20-750-DUCT2-F8	2	20-750-DUCT2-F8	3
Duct, Bottom Inlet	Recommended	20-750-DUCT4-F8	1	20-750-DUCT4-F8	2	20-750-DUCT4-F8	3
Roll-Out Cart	Recommended	20-750-CART1-F8	1	20-750-CART1-F8	1	20-750-CART1-F8	1
Control Power Circuit Breaker §	Recommended	1489-A2D130	1	1489-A2D130	2	1489-A2D130	3
Control Power Circuit Breaker Lock §	Recommended	1489-AALOA	1	1489-AALOA	2	1489-AALOA	3
EMC Core, Converter Input, AC Input	Optional	20-750-EMCBUS1-F8	1	20-750-EMCBUS1-F8	2	20-750-EMCBUS1-F8	3
EMC Core, Inverter Output	Optional	20-750-EMCCM1-F8	1	20-750-EMCCM1-F8	2	20-750-EMCCM1-F8	3

§ Common DC input drives only.

♣ EMC cores are included with the 20-750-BUS5-Fx kits.

△ 24 volt supply cable is included with each Frame 8 drive unit.

♦ 20-750-PH1-Fx and 20-750-FCBL1-Fx kits are used if the Control Pod is mounted in the drive. If the Control Pod is to be remote mounted (up to 23 m or 75 ft away), order a 20-750-RPD1-Fx kit instead.



## Cabinet Options

For proper alignment and installation of a 2100 Transition Section, the MCC must be equipped with a 1.5 in. mounting channel.

### PowerFlex 755 2100 Transition Section <sup>∇</sup>

Description	Cat. No.	Frame
Left Mount Transition Section, 20 inch Depth, Cabinet, Gray with removable 1.5 in. Mounting Channel	20-750-XSEC-LH-20G	8...10
Right Mount Transition Section, 20 inch Depth, Cabinet, Gray with removable 1.5 in. Mounting Channel	20-750-XSEC-RH-20G	8...10
Right or Left Mount Transition Section, 15 inch Depth, Cabinet, Gray with removable 1.5 in. Mounting Channel	20-750-XSEC-BH-15G	8...10
Left Mount, Bus Bar Splice Kit, Bumped Back, 1200 A with 1.5 in. Mounting Channel ★	20-750-XBUS-LHBB-1200	8...10
Left Mount, Bus Bar Splice Kit, Bumped Back, 2000 A with 1.5 in. Mounting Channel ★	20-750-XBUS-LHBB-2000	8...10
Left Mount, Bus Bar Splice Kit, Bumped Back, 3000 A with 1.5 in. Mounting Channel ★	20-750-XBUS-LHBB-3000	8...10
Left Mount, Bus Bar Splice Kit, Non-Bumped Back, 1200 A with 1.5 in. Mounting Channel ★	20-750-XBUS-LHNB-1200	8...10
Left Mount, Bus Bar Splice Kit, Non-Bumped Back, 2000 A with 1.5 in. Mounting Channel ★	20-750-XBUS-LHNB-2000	8...10
Left Mount, Bus Bar Splice Kit, Non-Bumped Back, 3000 A with 1.5 in. Mounting Channel ★	20-750-XBUS-LHNB-3000	8...10
Right Mount, Bus Bar Splice Kit, Bumped Back, 1200 A with 1.5 in. Mounting Channel ‡	20-750-XBUS-RHBB-1200	8...10
Right Mount, Bus Bar Splice Kit, Bumped Back, 2000 A with 1.5 in. Mounting Channel ‡	20-750-XBUS-RHBB-2000	8...10
Right Mount, Bus Bar Splice Kit, Bumped Back, 3000 A with 1.5 in. Mounting Channel ‡	20-750-XBUS-RHBB-3000	8...10
Right Mount, Bus Bar Splice Kit, Non-Bumped Back, 1200 A with 1.5 in. Mounting Channel ‡	20-750-XBUS-RHNB-1200	8...10
Right Mount, Bus Bar Splice Kit, Non-Bumped Back, 2000 A with 1.5 in. Mounting Channel ‡	20-750-XBUS-RHNB-2000	8...10
Right Mount, Bus Bar Splice Kit, Non-Bumped Back, 3000 A with 1.5 in. Mounting Channel ‡	20-750-XBUS-RHNB-3000	8...10
Left Mount, Bus Bar Splice Kit, Bumped Back, 1200 A without Mounting Channel ★	20-750-XBUS-LLBB-1200	8...10
Left Mount, Bus Bar Splice Kit, Bumped Back, 2000 A without Mounting Channel ★	20-750-XBUS-LLBB-2000	8...10
Left Mount, Bus Bar Splice Kit, Bumped Back, 3000 A without Mounting Channel ★	20-750-XBUS-LLBB-3000	8...10
Left Mount, Bus Bar Splice Kit, Non-Bumped Back, 1200 A without Mounting Channel ★	20-750-XBUS-LLNB-1200	8...10
Left Mount, Bus Bar Splice Kit, Non-Bumped Back, 2000 A without Mounting Channel ★	20-750-XBUS-LLNB-2000	8...10
Left Mount, Bus Bar Splice Kit, Non-Bumped Back, 3000 A without Mounting Channel ★	20-750-XBUS-LLNB-3000	8...10
Right Mount, Bus Bar Splice Kit, Bumped Back, 1200 A without Mounting Channel ‡	20-750-XBUS-RLBB-1200	8...10
Right Mount, Bus Bar Splice Kit, Bumped Back, 2000 A without Mounting Channel ‡	20-750-XBUS-RLBB-2000	8...10
Right Mount, Bus Bar Splice Kit, Bumped Back, 3000 A without Mounting Channel ‡	20-750-XBUS-RLBB-3000	8...10
Right Mount, Bus Bar Splice Kit, Non-Bumped Back, 1200 A without Mounting Channel ‡	20-750-XBUS-RLNB-1200	8...10
Right Mount, Bus Bar Splice Kit, Non-Bumped Back, 2000 A without Mounting Channel ‡	20-750-XBUS-RLNB-2000	8...10
Right Mount, Bus Bar Splice Kit, Non-Bumped Back, 3000 A without Mounting Channel ‡	20-750-XBUS-RLNB-3000	8...10

★ Left side of drive to right side of 2100 MCC.

‡ Right side of drive to left side of 2100 MCC.

∇ Requires the appropriate drive option P20, P22 or P24, which is dependent on the back bus ampacity.

### PowerFlex 755 2500 Splice Kits

Description	Cat No.	Frame
1200A Splice Kit to connect right side of drive to a CENTERLINE® 2500 cabinet	20-750-MBUSR1-1200	8...10
2000A Splice Kit to connect right side of drive to a CENTERLINE 2500 cabinet	20-750-MBUSR1-2000	8...10
3000A Splice Kit to connect right side of drive to a CENTERLINE 2500 cabinet	20-750-MBUSR1-3200	8...10
1200A Splice Kit to connect multiple Frame 8...10 drives or to connect left side of drive to a CENTERLINE 2500 cabinet	20-750-MBUSL1-1200	8...10
2000A Splice Kit to connect multiple Frame 8...10 drives or to connect left side of drive to a CENTERLINE 2500 cabinet	20-750-MBUSL1-2000	8...10
3000A Splice Kit to connect multiple Frame 8...10 drives or to connect left side of drive to a CENTERLINE 2500 cabinet	20-750-MBUSL1-3200	8...10

## Cabinet Options (continued)

## PowerFlex 755 Empty Option Bay \*

Description	Cat. No.	Frame
Option Bay, 600 mm wide by 600 mm deep, Beige	20-750-PBAY-66	8...10
Option Bay, 800 mm wide by 600 mm deep, Beige	20-750-PBAY-86	8...10
Option Bay, 1200 mm wide by 600 mm deep, Beige	20-750-PBAY-126	8...10
Option Bay, 600 mm wide by 800 mm deep, Beige	20-750-PBAY-68	8...10
Option Bay, 800 mm wide by 800 mm deep, Beige	20-750-PBAY-88	8...10
Option Bay, 1200 mm wide by 800 mm deep, Beige	20-750-PBAY-128	8...10
Option Bay Hardware Kit (one kit is required for each cabinet selected)	20-750-PBAY-HWD-1	8...10
Option Bay Seal Kit, IP54	20-750-PBAY-IP54	8...10
Empty Bay, RH Bus Bar, 975 A Maximum	20-750-PBAY-RHBB-975	8...10
Empty Bay, RH Bus Bar, 1235 A Maximum	20-750-PBAY-RHBB-1235	8...10
Empty Bay, RH Bus Bar, 1625 A Maximum	20-750-PBAY-RHBB-1625	8...10
Empty Bay, RH Bus Bar, 2437 A Maximum	20-750-PBAY-RHBB-2437	8...10
Right Mount Bus Bar, Cable Connection, 2-Hole	20-750-PBAY-LBRK-2	8...10
Right Mount Bus Bar, Cable Connection, 4-Hole	20-750-PBAY-LBRK-4	8...10
Right Mount Bus Bar, Installation Kit, 3-Phase Connection	20-750-PBAY-INS-3	8...10
Right Mount Bus Bar, Installation Kit, DC Connection	20-750-PBAY-INS-2	8...10
Rear Drive Bus Bar, Cable Connection	20-750-PBAY-RBRK-2	8...10

\* Contact your local Rockwell Automation sales office or Allen-Bradley distributor for availability.

## Drive Options - AC Input (2500 MCC Style Cabinet)

To configure a catalog number for a drive with options:

1. Select the base drive catalog number from the tables that follow.
2. Select the System Overload Duty Cycle and Power Disconnect options from the Required Options table. Add the desired option codes to the end of the base catalog number, separating each option code with a dash. For example:  
21G1AxC460JN0NNNNN-**LD-P3**.
3. Select other options from the Additional Options table. Add the option code(s) to the end of the catalog number separating each code with a dash. For example: 21G1AxC460JN0NNNNN-**LD-P3-P11**.

### Required Options ‡

Type	Option	Frame	Description	
System Overload Duty Cycle $\Delta$ $\blacklozenge$	LD	Light Duty	8...10 100% continuous current, 110% current for 1 minute.	
	ND	Normal Duty		100% continuous current, 110% current for 1 minute, 150% for 3 seconds.
	HD	Heavy Duty		100% continuous current, 150% current for 1 minute, 180% for 3 seconds.
Power Disconnect $\Delta$	P3	Input Thermal Magnetic Circuit Breaker	8...10 This option is for disconnecting drive power. An Allen-Bradley 140U Molded Case Circuit Breaker is provided. All switches include flange style handle operators that are door interlocking and padlockable.	
	P5	Input Non-Fused Molded Case Disconnect Switch	8 Only This option is for disconnecting drive power. An Allen-Bradley 140U Molded Case Switch is provided. All switches include flange style handle operators that are door interlocking and padlockable. Please note that PowerFlex 755 Frame 8 converter modules have input fuses installed as standard equipment.	
Wiring Only Bay	P14	Wiring Only Bay	8...10 This option identifies that an extra bay will be provided for the purpose of wiring the drive. This option will extend the drive power bus from the drive bay into the option bay, making field connection options more flexible. No drive input protection is supplied with this option. Documentation to reflect input disconnection and protection is customer supplied. See page 98 for more information on power cable entry/exit locations.	

‡ Frame 9 and 10 drives require an 800 mm deep option bay when selecting any of the options on this page.

$\Delta$  Only one option of this type may be selected.

$\blacklozenge$  See previous selection tables for specific rating information.

### Additional Options ‡

Type	Option	Applicable Frame	Description
Contactors $\Delta$ $\blackspade$	P11	Input Contactor	8 Only A contactor is provided between the AC line and the drive. The contactor is controlled by customer supplied 120V AC (480V input) or 230V AC (400V input) remote contact closure logic. A terminal block for control is provided for customer use, and is wired to 1 N.O. and 1 N.C. auxiliary contact on the contactor. <b>Important:</b> The P11 option "Alternate Contact Circuit" is not intended to be used as a Start/Stop circuit.
	P12	Output Contactor	8 Only A contactor is provided between the drive output and the motor. The contactor is controlled by customer supplied 120V AC (480V input) or 230V AC (400V input) remote contact closure logic. A terminal block for control is provided for customer use and is wired to 1 N.O. and 1 N.C. auxiliary contact on the contactor. <b>Note:</b> As an alternative to an output contactor, certain safety applications can be satisfied using the PowerFlex 750-Series Safe Torque-Off Option Card (Cat. No. 20-750-S). Safe Torque-Off is ideal for safety related applications requiring removal of rotational power to the motor without removing power from the drive. Safe Torque-Off functionality offers the benefit of quick start-up after a demand on the safety system and helps reduce wear from repetitive start-up. It also provides safety ratings up to and including SIL CL3, PLe, and CAT 3.
Reactors $\Delta$ $\clubsuit$	L1	3% Input Reactor	8...9 Provides an open core drive input line reactor that mounts inside the drive enclosure. Typical impedance is 3%.
	L2	3% Output Reactor	8...9 Provides an open core drive output load reactor, which mounts inside the drive enclosure. Typical impedance is 3%.
	L3	5% Input Reactor	8 Only Provides an open core drive input line reactor that mounts inside the drive enclosure. Typical impedance is 5%.
	L4	5% Output Reactor	8 Only Provides an open core drive output load reactor, which mounts inside the drive enclosure. Typical impedance is 5%.
MCC Power Bus Capacity $\Delta$	P20	1250 Amp Bus	8...10 Provides a 1250 Amp MCC Bus.
	P22	2000 Amp Bus	8...10 Provides a 2000 Amp MCC Bus.
	P24	3000 Amp Bus	8...10 Provides a 3000 Amp MCC Bus.
UPS Control Bus	P30	UPS Control Bus, DC Input with Precharge	8...10 Provides a UPS Control Bus, DC Input with Precharge only.
Auxiliary Power	X1	Auxiliary Transformer	8 Only Auxiliary transformer providing 500VA. Available as an option on frame 8, IP20 units and standard on all other cabinet configurations.

‡ Frame 9 and 10 drives require an 800 mm deep option bay when selecting any of the options on this page.

$\Delta$  Only one option of this type may be selected.

$\blackspade$  Contactor options are not available for systems with MCC power bus.

$\clubsuit$  To accommodate a larger reactor, an 800 mm deep cabinet must be selected for the following Frame 8 drives; C750, C770, D710, D740 light duty (LD) and C770 normal-duty (ND).

## Drive Options - DC Input with Precharge (2500 MCC Style Cabinet)

To configure a catalog number for a drive with options:

1. Select the base drive catalog number from the tables that follow.
2. Select the System Overload Duty Cycle and MCC Power Bus Capacity from the Required Options table below. Add the UPC Control Bus option (if needed) to the end of the base catalog number, separating it with a dash. For example:  
21G14TF500ANONNNNN-ND-P22-P30.

### Required Options ‡

Type	Option		Applicable Frame	Description
System Overload Duty Cycle $\Delta$ $\blacklozenge$	LD	Light Duty	8...10	100% continuous current, 110% current for 1 minute.
	ND	Normal Duty		100% continuous current, 110% current for 1 minute, 150% for 3 seconds.
	HD	Heavy Duty		100% continuous current, 150% current for 1 minute, 180% for 3 seconds.
MCC Power Bus Capacity $\Delta$	P20	1250 Amp Bus	8...10	Provides a 1250 Amp MCC Bus.
	P22	2000 Amp Bus	8...10	Provides a 2000 Amp MCC Bus.
	P24	3000 Amp Bus	8...10	Provides a 3000 Amp MCC Bus.

‡ Frame 9 and 10 drives require an 800 mm deep option bay when selecting any of the options on this page.

$\Delta$  Only one option of this type may be selected.

$\blacklozenge$  See previous selection tables for specific rating information.

### Additional Options ‡

Type	Option		Applicable Frame	Description
UPS Control Bus	P30	UPS Control Bus, DC Input with Precharge	8...10	Provides a UPS Control Bus, DC Input with Precharge only.

‡ Frame 9 and 10 drives require an 800 mm deep option bay when selecting any of the options on this page.

### PowerFlex 755 Splice Kits for DC Input Drives with Precharge

Description	Cat No.	Frame
1200A Splice Kit to connect right side of drive to a CENTERLINE 2500 cabinet	20-750-DBUSR1-1200	8...10
2000A Splice Kit to connect right side of drive to a CENTERLINE 2500 cabinet	20-750-DBUSR1-2000	8...10
3000A Splice Kit to connect right side of drive to a CENTERLINE 2500 cabinet	20-750-DBUSR1-3200	8...10
1200A Splice Kit to connect multiple Frame 8...10 drives or to connect left side of drive to a CENTERLINE 2500 cabinet	20-750-DBUSL1-1200	8...10
2000A Splice Kit to connect multiple Frame 8...10 drives or to connect left side of drive to a CENTERLINE 2500 cabinet	20-750-DBUSL1-2000	8...10
3000A Splice Kit to connect multiple Frame 8...10 drives or to connect left side of drive to a CENTERLINE 2500 cabinet	20-750-DBUSL1-3200	8...10

## IP20, NEMA/UL Type 1 and Options (2500 MCC Style Cabinet)

### 380...400V AC, Three-Phase and 540V DC Input Drives \* ▽

Light Duty (-LD)			Normal Duty (-ND)				Heavy Duty (-HD)				Base Drive Cat. No. ★ §	Frame Size	
Output Amps			Output Amps				Output Amps						
Cont.	1 Min.	3 Sec.	kW	Cont.	1 Min.	3 Sec.	kW	Cont.	1 Min.	3 Sec.			kW
540	594	NA	315	460	506	693	250	385	578	693	200	21G1A#C460JNONNNNN	8
585	644		315	540	594	821	315	456	684	821	250	21G1A#C540JNONNNNN	8
612	673		355	567	624	851	315	472	708	851	250	21G1A#C567JNONNNNN	8
750	825		400	650	715	975	355	540	810	975	315	21G1A#C650JNONNNNN	8
796	876		450	750	825	1125	400	585	878	1125	315	21G1A#C750JNONNNNN	8
832	915		450	770	847	1155	400	642	963	1155	355	21G1A#C770JNONNNNN	8
1040	1144		560	910	1001	1365	500	750	1125	1365	400	21G11#C910JNONNNNN	9
1090	1199		630	1040	1144	1584	560	880	1320	1584	500	21G11#C1K0JNONNNNN	9
1175	1293		710	1090	1199	1638	630	910	1365	1638	500	21G11#C1K1JNONNNNN	9
1465	1612		800	1175	1293	1872	710	1040	1560	1962	560	21G11#C1K2JNONNNNN	9
1480	1628		850	1465	1612	2198	800	1090	1635	2198	630	21G11#C1K4JNONNNNN	9
1600	1760		900	1480	1628	2220	850	1175	1763	2220	710	21G11#C1K5JNONNNNN	9
1715	1887		1000	1590	1749	2385	900	1325	1988	2385	710	21G11#C1K6JNONNNNN	10
2330	2563		1400	2150	2365	3225	1250	1800	2700	3225	1000	21G11#C2K1JNONNNNN	10

- § The 5th character determines Input Type. "1" = AC and DC input with precharge. "4" = DC input with precharge. "A" = AC input with precharge and no DC terminals.
- ‡ The 6th character determines Enclosure Type and Depth. "B" = IP20, NEMA/UL Type 1, MCC style 600 mm (23.6 in.) deep. "L" = IP20, NEMA/UL Type 1, MCC style 800 mm (31.5 in.) deep. "P" = Packaged Drive - IP20, NEMA/UL Type 1, MCC style with MCC bus, 800 mm (31.5 in.) deep. "W" = Packaged Drive - IP20, NEMA/UL Type 1, MCC style with MCC bus, 800 mm (31.5 in.) deep, gray. Refer to Power Wiring Options on page 98.
- ★ The 11th character determines default Filtering and Common Mode Cap jumper configuration. "J" = Installed, "A" = Removed.
- ▽ A Roll-out Cart is required with Frame 8...10 drives to assist with power wiring and cabinet mounting. Refer to page 121.
- \* Contact your local Rockwell Automation sales office or Allen-Bradley distributor for availability.

### 480V AC, Three-Phase and 650V DC Input Drives \* ▽

Light Duty (-LD)			Normal Duty (-ND)				Heavy Duty (-HD)				Base Drive Cat. No. §	Frame Size	
Output Amps			Output Amps				Output Amps						
Cont.	1 Min.	3 Sec.	Hp	Cont.	1 Min.	3 Sec.	Hp	Cont.	1 Min.	3 Sec.			Hp
485	534	NA	400	430	473	666	350	370	555	666	300	21G1A#D430ANONNNNN	8
545	600		450	485	534	745	400	414	621	745	350	21G1A#D485ANONNNNN	8
590	649		500	545	600	818	450	454	681	818	350	21G1A#D545ANONNNNN	8
710	781		600	617	679	926	500	485	728	926	400	21G1A#D617ANONNNNN	8
765	842		650	710	781	1065	600	545	818	1065	450	21G1A#D710ANONNNNN	8
800	880		700	740	817	1110	650	617	926	1110	500	21G1A#D740ANONNNNN	8
960	1056		800	800	880	1278	700	710	1065	1278	600	21G11#D800ANONNNNN	9
1045	1150		900	960	1056	1440	800	795	1193	1440	700	21G11#D960ANONNNNN	9
1135	1249		1000	1045	1150	1568	900	800	1200	1568	750	21G11#D1K0ANONNNNN	9
1365	1502		1100	1135	1249	1728	1000	960	1440	1728	800	21G11#D1K2ANONNNNN	9
1420	1562		1250	1365	1502	2048	1100	1045	1568	2048	900	21G11#D1K3ANONNNNN	9
1540	1694		1350	1420	1562	2130	1250	1135	1703	2130	1000	21G11#D1K4ANONNNNN	9
1655	1821		1500	1525	1678	2288	1350	1270	1905	2288	1100	21G11#D1K5JNONNNNN	10
2240	2464		2000	2070	2277	3105	1750	1730	2595	3105	1650	21G11#D2K0JNONNNNN	10

- § The 5th character determines Input Type. "1" = AC and DC input with precharge. "4" = DC input with precharge. "A" = AC input with precharge and no DC terminals.
- ‡ The 6th character determines Enclosure Type and Depth. "B" = IP20, NEMA/UL Type 1, MCC style 600 mm (23.6 in.) deep. "L" = IP20, NEMA/UL Type 1, MCC style 800 mm (31.5 in.) deep. "P" = Packaged Drive - IP20, NEMA/UL Type 1, MCC style with MCC bus, 800 mm (31.5 in.) deep. "W" = Packaged Drive - IP20, NEMA/UL Type 1, MCC style with MCC bus, 800 mm (31.5 in.) deep, gray. Refer to Power Wiring Options on page 98.
- ▽ A Roll-out Cart is required with Frame 8...10 drives to assist with power wiring and cabinet mounting. Refer to page 121.
- \* Contact your local Rockwell Automation sales office or Allen-Bradley distributor for availability.

## IP20, NEMA/UL Type 1 and Options (continued)

## 600V AC, Three-Phase and 810V DC Input Drives \* ▽

Light Duty (-LD)				Normal Duty (-ND)				Heavy Duty (-HD)				Base Drive Cat. No. §	Frame Size
Output Amps			Hp	Output Amps			Hp	Output Amps			Hp		
Cont.	1 Min.	3 Sec.		Cont.	1 Min.	3 Sec.		Cont.	1 Min.	3 Sec.			
355	391	NA	350	295	325	490	300	272	408	490	250	21G1A#E295ANONNNNN	8
395	435		400	355	391	533	350	295	443	533	300	21G1A#E355ANONNNNN	8
435	479		450	395	435	593	400	329	494	593	350	21G1A#E395ANONNNNN	8
460	506		500	435	479	639	450	355	533	639	350	21G1A#E435ANONNNNN	8
510	561		500	460	506	711	500	395	593	711	400	21G1A#E460ANONNNNN	8
545	600		550	510	561	765	500	425	638	765	450	21G1A#E510ANONNNNN	8
690	759		700	595	655	918	600	510	765	918	500	21G1#E595ANONNNNN	9
760	836		800	630	693	1071	700	595	893	1071	600	21G1#E630ANONNNNN	9
835	919		900	760	836	1140	800	630	945	1140	700	21G1#E760ANONNNNN	9
900	990		950	825	908	1260	900	700	1050	1260	750	21G1#E825ANONNNNN	9
980	1078		1000	900	990	1368	950	760	1140	1368	800	21G1#E900ANONNNNN	9
1045	1150		1100	980	1078	1470	1000	815	1223	1470	900	21G1#E980ANONNNNN	9
1220	1342		1200	1110	1221	1665	1100	920	1380	1665	1000	21G1#E1K1ANONNNNN	10
1530	1683		1500	1430	1573	2145	1400	1190	1785	2145	1250	21G1#E1K4ANONNNNN	10

§ The 5th character determines Input Type. "1" = AC and DC input with precharge. "4" = DC input with precharge. "A" = AC input with precharge and no DC terminals.

‡ The 6th character determines Enclosure Type and Depth. "B" = IP20, NEMA/UL Type 1, MCC style 600 mm (23.6 in.) deep. "L" = IP20, NEMA/UL Type 1, MCC style 800 mm (31.5 in.) deep. "P" = Packaged Drive - IP20, NEMA/UL Type 1, MCC style with MCC bus, 800 mm (31.5 in.) deep. "W" = Packaged Drive - IP20, NEMA/UL Type 1, MCC style with MCC bus, 800 mm (31.5 in.) deep, gray. Refer to Power Wiring Options on page 98.

▽ A Roll-out Cart is required with Frame 8...10 drives to assist with power wiring and cabinet mounting. Refer to page 121.

♣ Contact your local Rockwell Automation sales office or Allen-Bradley distributor for availability.

## 690V AC, Three-Phase and 932V DC Input Drives \* ▽

Light Duty (-LD)				Normal Duty (-ND)				Heavy Duty (-HD)				Base Drive Cat. No. ★ §	Frame Size
Output Amps			kW	Output Amps			kW	Output Amps			kW		
Cont.	1 Min.	3 Sec.		Cont.	1 Min.	3 Sec.		Cont.	1 Min.	3 Sec.			
330	363	NA	315	265	292	375	250	215	323	375	200	21G1A#F265ANONNNNN	8
370	407		355	330	363	473	315	265	398	473	250	21G1A#F330ANONNNNN	8
410	451		400	370	407	555	355	308	462	555	300	21G1A#F370ANONNNNN	8
460	506		450	415	457	639	400	370	555	639	355	21G1A#F415ANONNNNN	8
500	550		500	460	506	675	450	375	563	675	375	21G1A#F460ANONNNNN	8
530	583		530	500	550	750	500	413	620	750	400	21G1A#F500ANONNNNN	8
650	715		630	590	649	885	560	460	690	885	450	21G1#F590ANONNNNN	9
710	781		710	650	715	975	630	500	750	975	500	21G1#F650ANONNNNN	9
790	869		800	710	781	1065	710	590	885	1065	560	21G1#F710ANONNNNN	9
860	946		850	765	842	1170	750	650	975	1170	630	21G1#F765ANONNNNN	9
960	1056		900	795	875	1350	800	750	1125	1350	710	21G1#F795ANONNNNN	9
1020	1122		1000	960	1056	1440	900	795	1193	1440	800	21G1#F960ANONNNNN	9
1150	1265		1100	1040	1144	1560	1000	865	1298	1560	900	21G1#F1K0ANONNNNN	10
1485	1634		1500	1400	1540	2100	1400	1160	1740	2100	1120	21G1#F1K4ANONNNNN	10

§ The 5th character determines Input Type. "1" = AC and DC input with precharge. "4" = DC input with precharge. "A" = AC input with precharge and no DC terminals.

‡ The 6th character determines Enclosure Type and Depth. "B" = IP20, NEMA/UL Type 1, MCC style 600 mm (23.6 in.) deep. "L" = IP20, NEMA/UL Type 1, MCC style 800 mm (31.5 in.) deep. "P" = Packaged Drive - IP20, NEMA/UL Type 1, MCC style with MCC bus, 800 mm (31.5 in.) deep. "W" = Packaged Drive - IP20, NEMA/UL Type 1, MCC style with MCC bus, 800 mm (31.5 in.) deep, gray. Refer to Power Wiring Options on page 98.

★ The 11th character determines default Filtering and Common Mode Cap jumper configuration. "I" = Installed, "A" = Removed.

▽ A Roll-out Cart is required with Frame 8...10 drives to assist with power wiring and cabinet mounting. Refer to page 121.

♣ Contact your local Rockwell Automation sales office or Allen-Bradley distributor for availability.



## IP54, NEMA Type 12 and Options (2500 MCC Style Cabinet)

### 380...400V AC, Three-Phase and 540V DC Input Drives \* ▽

Light Duty (-LD)			Normal Duty (-ND)				Heavy Duty (-HD)				Base Drive Cat. No. ★ §	Frame Size	
Output Amps			Output Amps				Output Amps						
Cont.	1 Min.	3 Sec.	kW	Cont.	1 Min.	3 Sec.	kW	Cont.	1 Min.	3 Sec.			kW
540	594	NA	315	460	506	693	250	385	578	693	200	21G1A#C460JNONNNNN	8
585	644		315	540	594	821	315	456	684	821	250	21G1A#C540JNONNNNN	8
612	673		355	567	624	851	315	472	708	851	250	21G1A#C567JNONNNNN	8
750	825		400	650	715	975	355	540	810	975	315	21G1A#C650JNONNNNN	8
796	876		450	750	825	1125	400	585	878	1125	315	21G1A#C750JNONNNNN	8
832	915		450	770	847	1155	400	642	963	1155	355	21G1A#C770JNONNNNN	8
1040	1144		560	910	1001	1365	500	750	1125	1365	400	21G11#C910JNONNNNN	9
1090	1199		630	1040	1144	1584	560	880	1320	1584	500	21G11#C1K0JNONNNNN	9
1175	1293		710	1090	1199	1638	630	910	1365	1638	500	21G11#C1K1JNONNNNN	9
1465	1612		800	1175	1293	1872	710	1040	1560	1962	560	21G11#C1K2JNONNNNN	9
1480	1628		850	1465	1612	2198	800	1090	1635	2198	630	21G11#C1K4JNONNNNN	9
1600	1760		900	1480	1628	2220	850	1175	1763	2220	710	21G11#C1K5JNONNNNN	9
1715	1887		1000	1590	1749	2385	900	1325	1988	2385	710	21G11#C1K6JNONNNNN	10
2330	2563		1400	2150	2365	3225	1250	1800	2700	3225	1000	21G11#C2K1JNONNNNN	10

- § The 5th character determines Input Type. "1" = AC and DC input with precharge. "4" = DC input with precharge. "A" = AC input with precharge and no DC terminals.
- ‡ The 6th character determines Enclosure Type and Depth. "K" = IP54, NEMA Type 12, MCC style 800 mm (31.5 in.) deep, standard color. "Y" = IP54, NEMA Type 12, MCC style 800 mm (31.5 in.) deep, gray. Refer to Power Wiring Options on page 98.
- ★ The 11th character determines default Filtering and Common Mode Cap jumper configuration. "J" = Installed, "A" = Removed.
- ▽ A Roll-out Cart is required with Frame 8...10 drives to assist with power wiring and cabinet mounting. Refer to page 121.
- ♣ Contact your local Rockwell Automation sales office or Allen-Bradley distributor for availability.

### 480V AC, Three-Phase and 650V DC Input Drives \* ▽

Light Duty (-LD)			Normal Duty (-ND)				Heavy Duty (-HD)				Base Drive Cat. No. §	Frame Size	
Output Amps			Output Amps				Output Amps						
Cont.	1 Min.	3 Sec.	Hp	Cont.	1 Min.	3 Sec.	Hp	Cont.	1 Min.	3 Sec.			Hp
485	534	NA	400	430	473	666	350	370	555	666	300	21G1A#D430ANONNNNN	8
545	600		450	485	534	745	400	414	621	745	350	21G1A#D485ANONNNNN	8
590	649		500	545	600	818	450	454	681	818	350	21G1A#D545ANONNNNN	8
710	781		600	617	679	926	500	485	728	926	400	21G1A#D617ANONNNNN	8
765	842		650	710	781	1065	600	545	818	1065	450	21G1A#D710ANONNNNN	8
800	880		700	740	817	1110	650	617	926	1110	500	21G1A#D740ANONNNNN	8
960	1056		800	800	880	1278	700	710	1065	1278	600	21G11#D800ANONNNNN	9
1045	1150		900	960	1056	1440	800	795	1193	1440	700	21G11#D960ANONNNNN	9
1135	1249		1000	1045	1150	1568	900	800	1200	1568	750	21G11#D1K0ANONNNNN	9
1365	1502		1100	1135	1249	1728	1000	960	1440	1728	800	21G11#D1K2ANONNNNN	9
1420	1562		1250	1365	1502	2048	1100	1045	1568	2048	900	21G11#D1K3ANONNNNN	9
1540	1694		1350	1420	1562	2130	1250	1135	1703	2130	1000	21G11#D1K4ANONNNNN	9
1655	1821		1500	1525	1678	2288	1350	1270	1905	2288	1100	21G11#D1K5JNONNNNN	10 ♣
2240	2464		2000	2070	2277	3105	1750	1730	2595	3105	1650	21G11#D2K0JNONNNNN	10 ♣

- § The 5th character determines Input Type. "1" = AC and DC input with precharge. "4" = DC input with precharge. "A" = AC input with precharge and no DC terminals.
- ‡ The 6th character determines Enclosure Type and Depth. "K" = IP54, NEMA Type 12, MCC style 800 mm (31.5 in.) deep, standard color. "Y" = IP54, NEMA Type 12, MCC style 800 mm (31.5 in.) deep, gray. Refer to Power Wiring Options on page 98.
- ▽ A Roll-out Cart is required with Frame 8...10 drives to assist with power wiring and cabinet mounting. Refer to page 121.
- ♣ Contact your local Rockwell Automation sales office or Allen-Bradley distributor for availability.

## IP54, NEMA Type 12 and Options (continued)

## 600V AC, Three-Phase and 810V DC Input Drives \* ▽

Light Duty (-LD)				Normal Duty (-ND)				Heavy Duty (-HD)				Base Drive Cat. No. §	Frame Size
Output Amps			Hp	Output Amps			Hp	Output Amps			Hp		
Cont.	1 Min.	3 Sec.		Cont.	1 Min.	3 Sec.		Cont.	1 Min.	3 Sec.			
355	391	NA	350	295	325	490	300	272	408	490	250	21G1A#E295ANONNNNN	8
395	435		400	355	391	533	350	295	443	533	300	21G1A#E355ANONNNNN	8
435	479		450	395	435	593	400	329	494	593	350	21G1A#E395ANONNNNN	8
460	506		500	435	479	639	450	355	533	639	350	21G1A#E435ANONNNNN	8
510	561		500	460	506	711	500	395	593	711	400	21G1A#E460ANONNNNN	8
545	600		550	510	561	765	500	425	638	765	450	21G1A#E510ANONNNNN	8
690	759		700	595	655	918	600	510	765	918	500	21G11#E595ANONNNNN	9
760	836		800	630	693	1071	700	595	893	1071	600	21G11#E630ANONNNNN	9
835	919		900	760	836	1140	800	630	945	1140	700	21G11#E760ANONNNNN	9
900	990		950	825	908	1260	900	700	1050	1260	750	21G11#E825ANONNNNN	9
980	1078		1000	900	990	1368	950	760	1140	1368	800	21G11#E900ANONNNNN	9
1045	1150		1100	980	1078	1470	1000	815	1223	1470	900	21G11#E980ANONNNNN	9
1220	1342		1200	1110	1221	1665	1100	920	1380	1665	1000	21G11#E1K1ANONNNNN	10
1530	1683		1500	1430	1573	2145	1400	1190	1785	2145	1250	21G11#E1K4ANONNNNN	10

§ The 5th character determines Input Type. "1" = AC and DC input with precharge. "4" = DC input with precharge. "A" = AC input with precharge and no DC terminals.

‡ The 6th character determines Enclosure Type and Depth. "K" = IP54, NEMA Type 12, MCC style 800 mm (31.5 in.) deep, standard color. "Y" = IP54, NEMA Type 12, MCC style 800 mm (31.5 in.) deep, gray. Refer to Power Wiring Options on page 98.

▽ A Roll-out Cart is required with Frame 8...10 drives to assist with power wiring and cabinet mounting. Refer to page 121.

♣ Contact your local Rockwell Automation sales office or Allen-Bradley distributor for availability.

## 690V AC, Three-Phase and 932V DC Input Drives \* ▽

Light Duty (-LD)				Normal Duty (-ND)				Heavy Duty (-HD)				Base Drive Cat. No. ★ §	Frame Size
Output Amps			kW	Output Amps			kW	Output Amps			kW		
Cont.	1 Min.	3 Sec.		Cont.	1 Min.	3 Sec.		Cont.	1 Min.	3 Sec.			
330	363	NA	315	265	292	375	250	215	323	375	200	21G1A#F265ANONNNNN	8
370	407		355	330	363	473	315	265	398	473	250	21G1A#F330ANONNNNN	8
410	451		400	370	407	555	355	308	462	555	300	21G1A#F370ANONNNNN	8
460	506		450	415	457	639	400	370	555	639	355	21G1A#F415ANONNNNN	8
500	550		500	460	506	675	450	375	563	675	375	21G1A#F460ANONNNNN	8
530	583		530	500	550	750	500	413	620	750	400	21G1A#F500ANONNNNN	8
650	715		630	590	649	885	560	460	690	885	450	21G11#F590ANONNNNN	9
710	781		710	650	715	975	630	500	750	975	500	21G11#F650ANONNNNN	9
790	869		800	710	781	1065	710	590	885	1065	560	21G11#F710ANONNNNN	9
860	946		850	765	842	1170	750	650	975	1170	630	21G11#F765ANONNNNN	9
960	1056		900	795	875	1350	800	750	1125	1350	710	21G11#F795ANONNNNN	9
1020	1122		1000	960	1056	1440	900	795	1193	1440	800	21G11#F960ANONNNNN	9
1150	1265		1100	1040	1144	1560	1000	865	1298	1560	900	21G11#F1K0ANONNNNN	10
1485	1634		1500	1400	1540	2100	1400	1160	1740	2100	1120	21G11#F1K4ANONNNNN	10

§ The 5th character determines Input Type. "1" = AC and DC input with precharge. "4" = DC input with precharge. "A" = AC input with precharge and no DC terminals.

‡ The 6th character determines Enclosure Type and Depth. "K" = IP54, NEMA Type 12, MCC style 800 mm (31.5 in.) deep, standard color. "Y" = IP54, NEMA Type 12, MCC style 800 mm (31.5 in.) deep, gray. Refer to Power Wiring Options on page 98.

★ The 11th character determines default Filtering and Common Mode Cap jumper configuration. "J" = Installed, "A" = Removed.

▽ A Roll-out Cart is required with Frame 8...10 drives to assist with power wiring and cabinet mounting. Refer to page 121.

♣ Contact your local Rockwell Automation sales office or Allen-Bradley distributor for availability.

## Approximate Dimensions and Weights

Dimensions are in mm (in.) - weights are in kg (lb)

### IP00/IP20, NEMA/UL Type Open

Frame	H	W	D	Weight
1	400.5 (15.77)	110.0 (4.33)	211.0 (8.31)	6.00 (12.8)
2	424.2 (16.70)	134.5 (5.30)	212.0 (8.35)	7.80 (17.2)
3	454.0 (17.87)	190.0 (7.48)	212.0 (8.35)	11.80 (26.1)
4	474.0 (18.66)	222.0 (8.74)	212.0 (8.35)	13.60 (30.0)
5	550.0 (21.65)	270.0 (10.63)	212.0 (8.35)	20.40 (45.0)
6	665.5 (26.20)	308.0 (12.13)	346.4 (13.64)	38.60 (85.0)
7	881.5 (34.70)	430.0 (16.93)	349.6 (13.76)	72.60 . . . 108.90 (160.0 . . . 240.0)

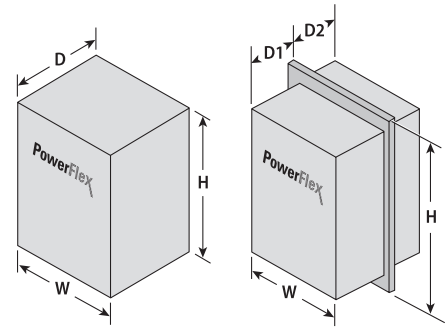

### IP20, NEMA/UL Type 1, MCC Style Cabinet

Frame	H	W	D	Weight ★
8	2453.0 (96.60)	600.0 (23.60)	600.0 (23.60) or 800.0 (31.50)	623.00 (1374.0)
8 with Drive and Option Cabinet	2453.0 (96.60)	1200.0 (47.20)	600.0 (23.60) or 800.0 (31.50)	1145.00 (2525.0)
9	2453.0 (96.60)	1200.0 (47.20)	600.0 (23.60) or 800.0 (31.50)	1246.00 (2748.0)
9 with Drive and Option Cabinet	2453.0 (96.60)	1800.0 (70.90)	800.0 (31.50)	2290.00 (5051.0)
10	2453.0 (96.60)	1800.0 (70.90)	600.0 (23.60) or 800.0 (31.50)	1869.00 (4122.0)
10 with Drive and Option Cabinet	2453.0 (96.60)	2400.0 (94.50)	800.0 (31.50)	3435.00 (7576.0)

★ Weights are approximate. Refer to the PowerFlex 750-Series Technical Data, publication 750-TD001 for detailed weight information.

### Flange Mount

Frame	H	W	D1	D2	Weight ★
2	481.8 (18.97)	206.2 (8.12)	148.3 (5.84)	63.7 (2.51)	8.00 (17.0)
3	515.0 (20.28)	260.0 (10.24)	127.4 (5.02)	84.6 (3.33)	12.00 (26.0)
4	535.0 (21.06)	292.0 (11.50)	127.4 (5.02)	84.6 (3.33)	14.00 (30.0)
5	611.0 (24.06)	340.0 (13.39)	127.4 (5.02)	84.6 (3.33)	20.00 (45.0)
6	665.5 (26.20)	308.0 (12.13)	208.4 (8.20)	138.0 (5.43)	38.00 (84.0)
7	875.0 (34.45)	430.0 (16.93)	208.4 (8.20)	138.0 (5.43)	96.00 (212.0)

★ Weights are approximate. Refer to the PowerFlex 750-Series Technical Data, publication 750-TD001 for detailed weight information.

## Approximate Dimensions and Weights (continued)

### IP54, NEMA/UL Type 12

Frame	H	W	D	Weight ★
2	543.2 (21.39)	215.3 (8.48)	222.2 (8.75)	8.00 (17.0)
3	551.0 (21.69)	268.0 (10.55)	220.1 (8.67)	12.00 (26.0)
4	571.0 (22.48)	300.0 (11.81)	220.1 (8.67)	14.00 (30.0)
5	647.0 (25.47)	348.0 (13.70)	220.1 (8.67)	20.00 (45.0)
6	1298.3 (51.11)	609.4 (23.99)	464.7 (18.30)	91.00 (200.0)
7	1614.0 (63.54)	609.4 (23.99)	464.7 (18.30)	162.00 (357.0)

★ Weights are approximate. Refer to the PowerFlex 750-Series Technical Data, publication 750-TD001 for detailed weight information.

### IP54, NEMA Type 12, MCC Style Cabinet

Frame	H	W	D	Weight ★
8	2477.0 (97.50)	600.0 (23.60)	800.0 (31.50) 898.0 (35.40) with Filter	644.00 (1419.0)
8 with Drive and Option Cabinets	2477.0 (97.50)	1200.0 (47.20)	800.0 (31.50) 898.0 (35.40) with Filter	1166.00 (2570.0)
9	2477.0 (97.50)	1200.0 (47.20)	800.0 (31.50) 898.0 (35.40) with Filter	1287.00 (2838.0)
9 with Drive and Option Cabinets	2477.0 (97.50)	1800.0 (70.90)	800.0 (31.50) 898.0 (35.40) with Filter	2332.00 (5141.0)
10	2477.0 (97.50)	1800.0 (70.90)	800.0 (31.50) 898.0 (35.40) with Filter	1931.00 (4257.0)
10 with Drive and Option Cabinets	2477.0 (97.50)	2400.0 (94.50)	800.0 (31.50) 898.0 (35.40) with Filter	3498.00 (7711.0)

★ Weights are approximate. Refer to the PowerFlex 750-Series Technical Data, publication 750-TD001 for detailed weight information.

### IP00, NEMA/UL Open Type ★

Frame	H	W	D
8	2145.0 (84.45)	777.9 (30.63)	424.9 (16.73)
9	2145.0 (84.45)	1577.8 (62.12)	424.9 (16.73)
10	2145.0 (84.45)	2377.9 (93.62)	424.9 (16.73)

★ Refer to the PowerFlex 750-Series Technical Data, publication 750-TD001 for detailed information.

### Maximum Component Weights - Frames 8...10

Component	AC Input	Common DC Input
Converter/DC Input with Precharge	64.00 (140.0)	64.00 (140.0)
Inverter	222.00 (490.0)	165.00 (363.0)
Drive Assembly (Open, IP00)	286.00 (630.0)	229.00 (504.0)

# PowerFlex 7-Class Options

## Human Interface Modules



Blank Plate



20-HIM-A3



20-HIM-A5



20-HIM-A6



20-HIM-C3S



20-HIM-C5S



20-HIM-C6S

Description	Cat. No.	Used with PowerFlex Drive					
		70	700	700H	700S	700L	753/755
No HIM (Blank Plate), Handheld/Local (Drive Mount)	20-HIM-A0	✓	✓	✓	✓	✓	✓
LCD Display, Full Numeric Keypad, Handheld/Local (Drive Mount)	20-HIM-A3	✓	✓	✓	✓	✓	
LCD Display, Programmer Only, Handheld/Local (Drive Mount)	20-HIM-A5	✓	✓	✓	✓	✓	
Enhanced, LCD, Full Numeric Keypad, Handheld/Local (Drive Mount)	20-HIM-A6	✓	✓	✓	✓	✓	✓
Remote (Panel Mount) LCD Display, Full Numeric Keypad★‡	20-HIM-C3S	✓	✓	✓	✓	✓	
Remote (Panel Mount) LCD Display, Programmer Only★‡	20-HIM-C5S	✓	✓	✓	✓	✓	
Enhanced, LCD, Full Numeric Keypad★‡	20-HIM-C6S	✓	✓	✓	✓	✓	✓

★ IP66, NEMA Type 4X/12—for indoor use only.

‡ Includes a 1202-C30 interface cable (3 m/9.8 ft) for connection to drive.

## Human Interface Module (HIM) Accessories

Description	Cat. No.	Used with PowerFlex Drive					
		70	700	700H	700S	700L	753/755
Bezel Kit for LCD HIMs, NEMA Type 1‡	20-HIM-B1	✓	✓	✓	✓	✓	✓
PowerFlex HIM Interface Cable, 1 m (3.3 ft) ♣	20-HIM-H10	✓	✓	✓	✓	✓	✓
Comm Option Cable Kit (Male-Male)							
0.33 m (1.1 ft)	1202-C03	✓	✓	✓	✓	✓	✓
1 m (3.3 ft)	1202-C10	✓	✓	✓	✓	✓	✓
3 m (9.8 ft)	1202-C30	✓	✓	✓	✓	✓	✓
9 m (29.5 ft)	1202-C90	✓	✓	✓	✓	✓	✓
Cable Kit (Male-Female) △							
0.33 m (1.1 ft)	1202-H03	✓	✓	✓	✓	✓	✓
1 m (3.3 ft)	1202-H10	✓	✓	✓	✓	✓	✓
3 m (9.8 ft)	1202-H30	✓	✓	✓	✓	✓	✓
9 m (29.5 ft)	1202-H90	✓	✓	✓	✓	✓	✓
DPI™ Cable Kit with Connectors, Tools and 100 m (328 ft) Cable	1202-CBL-KIT-100M	✓	✓	✓	✓	✓	✓
DPI Cable Connector Kit	1202-TB-KIT-SET	✓	✓	✓	✓	✓	✓
DPI/SCANport™ One to Two Port Splitter Cable	1203-S03	✓	✓	✓	✓	✓	✓

‡ Includes a 1202-C30 interface cable (3 m/9.8 ft) for connection to drive.

♣ Required only when HIM is used as handheld or remote.

△ Required in addition to 20-HIM-H10 for distances up to a total maximum of 10 m (32.8 ft).

## Communication Option Kits

Description	Cat. No.	Used with PowerFlex Drive					
		70	700	700H	700S	700L	753/755
BACnet/IP Option Module	20-750-BNETIP						✓
BACnet® MS/TP RS485 Communication Adapter	20-COMM-B	✓	✓	✓			
Coaxial ControlNet™ Option Module	20-750-CNETC						✓
ControlNet™ Communication Adapter (Coax)	20-COMM-C	✓	✓	✓	✓	✓	✓ §
DeviceNet™ Option Module	20-750-DNET						✓
DeviceNet™ Communication Adapter	20-COMM-D	✓	✓	✓	✓	✓	✓ §
Dual-port EtherNet/IP Option Module	20-750-ENETR						✓
EtherNet/IP™ Communication Adapter	20-COMM-E	✓	✓	✓	✓	✓	✓ §
Dual-port EtherNet/IP™ Communication Adapter	20-COMM-ER	✓	✓	✓	✓	✓	
HVAC Communication Adapter	20-COMM-H	✓	✓	✓	✓♣	✓	✓ §
CANopen® Communication Adapter	20-COMM-K	✓	✓	✓	✓	✓	✓ §
LonWorks® Communication Adapter	20-COMM-L	✓	✓	✓			✓ §
Modbus/TCP Communication Adapter	20-COMM-M	✓	✓	✓	✓	✓	✓ §
Profibus DPV1 Option Module	20-750-PBUS						✓
Single-port Profinet I/O Option Module	20-750-PNET						✓
Dual-port Profinet I/O Option Module	20-750-PNET2P						✓
PROFIBUS™ DP Communication Adapter	20-COMM-P	✓	✓	✓	✓	✓	✓ §
ControlNet™ Communication Adapter (Fiber)	20-COMM-Q	✓	✓	✓	✓	✓	✓ § &
Remote I/O Communication Adapter Δ	20-COMM-R	✓	✓	✓	✓	✓	✓ §
RS485 DF1 Communication Adapter	20-COMM-S	✓	✓	✓	✓	✓	✓ §
External Communications Kit Power Supply	20-XCOMM-AC-PS1	✓	✓	✓	✓	✓	✓
DPI External Communications Kit	20-XCOMM-DC-BASE	✓	✓	✓	✓	✓	✓
External DPI I/O Option Board ◆	20-XCOMM-IO-OPT1	✓	✓	✓	✓	✓	✓
Compact I/O Module (3 Channel)	1769-SM1	✓	✓	✓	✓	✓	✓
DriveLogix ControlNet Communication Adapter (Coax) ‡	1788-CNC				✓	✓∇	
DriveLogix Comm Option, ControlNet Redundant (Coax) ‡	1788-CNCR				✓	✓∇	
DriveLogix Comm Option, ControlNet (Fiber) ‡	1788-CNF				✓	✓∇	
DriveLogix Comm Option, ControlNet Redundant (Fiber) ‡	1788-CNFR				✓	✓∇	
DriveLogix Comm Option, DeviceNet (Open Conn.) ‡	1788-DNBO				✓	✓∇	
DriveLogix Comm Option, EtherNet/IP (Twisted Pair) ‡	1788-ENBT				✓	✓∇	
DriveLogix5730 Comm Option, Embedded EtherNet/IP	20D-DL2-ENETO				✓	✓∇	

◆ For use only with DPI External Communications Kits 20-XCOMM-DC-BASE.

♣ Only Modbus RTU can be used.

‡ For use with DriveLogix option only. Requires Logix Expansion Board (20D-DL2-LEB0).

§ Requires a Communication Carrier Card (20-750-20COMM or 20-750-20COMM-F1). Refer to page 117 for compatibility details.

∇ When using a PowerFlex 700S control.

Δ This item has Silver Series status. For information, refer to <http://www.ab.com/silver>.

& Not supported in Frame 1.

## PowerFlex 750-Series Legacy Communication Compatibility

Most legacy communication adapters (20-COMM) can be used with the PowerFlex 753/755. However, the restrictions stated below do apply.

Frame 1 - It is recommended that the 20-750-20COMM-F1 Communication Carrier Card only be installed in Port 4. Port 5 will not be accessible when this module is installed.

Frames 2 and larger - It is recommended that the 20-750-20COMM Communication Carrier Card be installed in Port 6. Using Port 4 or 5 will make the adjacent left port inaccessible to other option modules and may interfere with network cable connections.

**PowerFlex 750-Series Legacy Communication Compatibility (continued)**

Adapter	Accesses Ports 2, 3 and 6 for I/O Connections (Implicit & Explicit Messaging)	Accesses Port 7...14 Devices	Supports Drive Add On Profiles	Supports Asian-Languages ♦
20-COMM-B	Not Compatible			
20-COMM-C	✓ ‡	✓ v3.001 ♣	✓ Δ	✓ v3.001 ♣
20-COMM-D		Not Compatible		
20-COMM-E		✓ v4.001 ♣	✓ Δ	✓ v4.001 ♣
20-COMM-H	✓ v2.009 §	Not Compatible		
20-COMM-K	✓ v1.001 ♣			
20-COMM-L	✓ v1.007 ♣			
20-COMM-M	✓ ‡	✓ v2.001 ♣	Not Compatible	✓ v2.001 ♣
20-COMM-Q	✓ ‡	✓ v3.001 ♣	✓ Δ	✓ v3.001 ♣
20-COMM-R		Not Compatible		
20-COMM-S		Not Compatible		

- ‡ Controller must be capable of reading/writing 32-bit floating point (REAL) values.
- § Supports all three modes of operation (RTU, P1, N2).
- ♣ Requires this adapter firmware version or higher.
- Δ Requires firmware version v1.05 or higher of the drive Add On Profiles for Studio 5000 Logix Designer software.
- ♦ Chinese, Japanese, and Korean languages are supported at the time of publication.

**Communication Accessories**

Description	Cat. No.	Used with PowerFlex Drive					
		70	700	700H	700S	700L	753/755
Serial Null Modem Adapter	1203-SNM	✓	✓	✓	✓	✓	✓
Smart Self-powered Serial Converter (RS232) includes 1203-SFC and 1202-C10 Cables	1203-SSS	✓	✓	✓	✓	✓	✓
Universal Serial Bus™ (USB) Converter includes 2m USB, 20-HIM-H10 & 22-HIM-H10 Cables	1203-USB	✓	✓	✓	✓	✓	✓
ControlNet T-tap straight	1786-TPS						✓
ControlNet T-tap right angle	1786-TPR				✓	✓	
Communication Carrier Card for PowerFlex 750-Series Frame 1 drives	20-750-20COMM-F1						✓
Communication Carrier Card for PowerFlex 750-Series Frame 2 or higher drives	20-750-20COMM						✓

**I/O Option Kits**

Description	Cat. No.	Used with PowerFlex Drive					
		70	700	700H	700S	700L	753/755
24V DC Digital Inputs (6) with Analog I/O (4), Slot A ♣	20C-DA1-A			✓			
115V AC Digital Inputs (6) with Analog I/O (4), Slot A ♣	20C-DA1-B			✓			
115V AC Digital Outputs (3), Slot B ♣	20C-DO1			✓			
ATEX Option Module with 1 Thermosensor Input Connection (requires 11-Series I/O Module below)	20-750-ATEX						✓ §
24V DC 11-Series I/O Module with 1 Analog In, 1 Analog Out, 3 Digital In and 2 Relay Outputs	20-750-1132C-2R						✓ §
24V DC 11-Series I/O Module with 1 Analog In, 1 Analog Out, 3 Digital In, 1 Relay and 2 Transistor Outputs	20-750-1133C-1R2T						✓ §
115V AC 11-Series I/O Module with 1 Analog In, 1 Analog Out, 3 Digital In and 2 Relay Outputs	20-750-1132D-2R						✓ §
24V DC 22-Series I/O Module with 2 Analog In, 2 Analog Out, 6 Digital In and 2 Relay Outputs	20-750-2262C-2R						✓ §
115V AC 22-Series I/O Module with 2 Analog In, 2 Analog Out, 6 Digital In and 2 Relay Outputs	20-750-2262D-2R						✓ §
24V DC 22-Series I/O Module with 2 Analog In, 2 Analog Out, 6 Digital In, 3 Digital Out, 1 Relay and 2 Transistor Outputs	20-750-2263C-1R2T						✓ §

- ♣ Only one card allowed per slot.
- § I/O option kits are not allowed in CIP motion mode.



## Safety Options

Description	Cat. No.	Used with PowerFlex Drive					
		70	700	700H	700S	700L	753/755
DriveGuard Safe Torque-Off	20A-DG01	✓					
DriveGuard Safe Torque-Off with 2nd Encoder	20D-P2-DG01				✓	✓▽	
Safe Torque-Off (ATEX capable) ▲	20C-DG1			✓			
Safe Torque-Off	20-750-S						✓★
Safe Speed Monitor	20-750-S1						✓★‡

▲ Only one card allowed per slot.

▽ When using PowerFlex 700S control. This option kit cannot be used on Frame 2 drives, however it is available as a factory installed option.

‡ Requires the Dual Incremental Encoder or Universal Feedback Option. Also requires the 20-750-EMCSSM1-F8 EMC Option Kit with Frame 8...9 drives.

★ Drive can accommodate only one option.

## Feedback Options

Description	Cat. No.	Used with PowerFlex Drive					
		70	700	700H	700S	700L	753/755
5V/12V Encoder &	20A-ENC-1	✓					
12V/5V Encoder	20B-ENC-1		✓ #			✓ #	
Multi-Device Interface ♦	20D-MDI-C2				✓	✓▽	
2nd Encoder, 5V/12V ♦	20D-P2-ENCO				✓	✓▽	
Resolver ♦	20D-RES-A1				✓	✓▽	
Stegmann High Resolution Hyperface Encoder ♦	20D-STEG-B1				✓	✓▽	
Heidenhain High Resolution EnDat Encoder	20D-HEID-D0				✓	✓▽	
Incremental Encoder	20-750-ENC-1						✓▲
Dual Incremental Encoder	20-750-DENC-1						✓▲
Universal Feedback (includes Stegmann, Heidenhain, SSI, Biss, 5V Incremental)	20-750-UFB-1						✓▲

& Works only with PowerFlex 70 Enhanced Control.

♦ Requires Expanded Cassette

# When using a PowerFlex 700 with Vector Control.

★ PowerFlex 755 only.

▽ When using a PowerFlex 700S control.

▲ Homing and registration functions are not supported when using this device with Studio 5000 Logix Designer embedded motion instructions. To use these functions, the Universal Feedback Board (20-750-UFB-1) must be used.

## PowerFlex 700 Control Option Kits

Control with I/O	Factory Installed Cat. Code #	Cat. No.	Used with PowerFlex Drive					
			70	700	700H	700S	700L	753/755
Vector Control - 24V DC with: ▽								
60 Hz Maximum	NNAD	20B-VECT-COAD		✓				
82 Hz Maximum	NNAX	20B-VECTB-COAX		✓				
Cascading Fan/Pump Control	NNAE	20B-VECT-COAE		✓				
Pump Off (for Pump Jack)	NNBA	20B-VECTB-COBA		✓				
Vector Control - 115V AC ▽								
Vector Control - 115V AC with: ▽								
60 Hz Maximum	NNAD	20B-VECT-DOAD		✓				
82 Hz Maximum	NNAX	20B-VECTB-DOAX		✓				
Cascading Fan/Pump Control	NNAE	20B-VECT-DOAE		✓				
Pump Off (for Pump Jack)	NNBA	20B-VECT-DOBA		✓				

▽ Vector Control option utilizes DPI Only.

# This code is entered at the end of the drive catalog number (positions 17...20).

& This code is entered at position 15 of the drive catalog number.

## PowerFlex 750-Series Option Kits

	Description	Frame	Cat. No.	Used with PowerFlex Drive					
				70	700	700H	700S	700L	753/755
Auxiliary Power Supply	24V Aux Power Supply	2...7 Δ	20-750-APS						✓
DC Bus Bar Option Kit	DC Bus Bars for 380...480V AC drives	6	20-750-DCBB1-F6						✓
		7	20-750-DCBB1-F7						✓
	DC Bus Bars for 600...690V AC drives	6	20-750-DCBB2-F6						✓
		7	20-750-DCBB2-F7						✓
DC Bus Connection Kit	Connects the drive DC bus terminals to the cabinet bus rails.	8...10	20-750-BUS1A-F8						✓
EMC Option Kit	EMC Plate with Core for 380...480V AC drives	1	20-750-EMC1-F1						✓
		2	20-750-EMC1-F2						✓
		3	20-750-EMC1-F3						✓
	EMC Plate with Core for 600V AC drives	3	20-750-EMC3-F3						✓
	EMC Plate with Cores for 380...480V AC drives	4	20-750-EMC1-F4						✓
		5	20-750-EMC1-F5						✓
	EMC Plate with Cores for 600V AC drives	4	20-750-EMC3-F4						✓
		5	20-750-EMC3-F5						✓
	EMC Core for 380...480V AC drives	1	20-750-EMC2-F1						✓
		2	20-750-EMC2-F2						✓
		3	20-750-EMC2-F3						✓
	EMC Core for 600V AC drives	3	20-750-EMC4-F3						✓
	EMC Cores for 380...480V AC drives	4...5	20-750-EMC2-F45						✓
		EMC Cores for 600V AC drives	4	20-750-EMC4-F4					
	5		20-750-EMC4-F5						✓
	EMC Plate with Cores for 600...690V AC drives	6	20-750-EMC4-F6						✓
		7	20-750-EMC4-F7						✓
	EMC Plate with Cores for 600...690V AC drives (IP54 Only)	6	20-750-EMC5-F6						✓
		7	20-750-EMC5-F7						✓
	EMC Core – Inverter-mounted output, for 380...690V AC input and DC input drives.	8...10	20-750-EMCCM1-F8						✓
EMC Core – Cabinet-mounted input, for 380...690V Common DC Input drives only.	8...10	20-750-CBPEMCCM1-F8						✓	
EMC Core – Cabinet-mounted input, for 380...690V AC input drives only.	8...10	20-750-EMCCM1-F9						✓	
EMC Cores – Required when using the Safe Speed Monitor option 20-750-S1 with 380...690V drives.	8...10	20-750-EMCSSM1-F8						✓	
Door Shielding Kit		8...10	20-750-EMCDK1-F10						✓
Exhaust Hood	Exhaust Hood – IP20, NEMA/UL Type 1 drives.	8	20-750-HOOD1-F8						✓
Flange Adapter Kit	Converts Open Type drive to external heatsink (flange) with NEMA/UL Type 1 integrity backside. This kit is for use with IP20, NEMA/UL Type 0 drives and <b>will not provide</b> an air-tight or water-tight seal. Where sealing is required (e.g. contaminated, dirty or wet environments), a drive with an “F” enclosure option must be used.	2	20-750-FLNG1-F2						✓
		3	20-750-FLNG1-F3						✓
		4	20-750-FLNG1-F4						✓
		5	20-750-FLNG1-F5						✓
	Converts Open Type drive to external heatsink (flange) with NEMA/UL Type 4X/12 integrity backside.	6	20-750-FLNG4-F6						✓
7	20-750-FLNG4-F7							✓	
L Bus Bar Kit	Includes three L-brackets	8...10	20-750-LBRKT1						✓
NEMA/UL Type 1 Option Kit	NEMA/UL Type 1 Kit	1	20-750-NEMA1-F1						✓
		2	20-750-NEMA1-F2						✓
		3	20-750-NEMA1-F3						✓
		4	20-750-NEMA1-F4						✓
		5	20-750-NEMA1-F5						✓
		6	20-750-NEMA1-F6						✓
		7	20-750-NEMA1-F7						✓
Power Terminal Extension	Allows connection of two parallel leads to the AC terminals.	6	20-750-ACTE1-F6						✓

continued

## PowerFlex 750-Series Option Kits (continued)

Description	Frame	Cat. No.	Used with PowerFlex Drive						
			70	700	700H	700S	700L	753/755	
Power Terminal Guard	Provides additional ingress protection on power terminals.	6	20-750-PTG1-F6						✓
		7	20-750-PTG1-F7						✓
Remote Control POD Mounting Kit	Hardware, fiber-optic, and power supply cables to remotely mount the control POD up to 23 m (75 ft) from the drive.	8...10	20-750-RPD1-F8						✓
Roll-Out Cart	A wheeled roll-out cart that facilitates drive installation and removal. Required for Frame 8 and larger drives.	8...10	20-750-CART1-F8						✓

△ Frame 8 and up drives can be powered from an external 24V DC source, a 20-750-APS is not required.

## Other Options

Description	Cat. No.	Used with PowerFlex Drive					
		70	700	700H	700S	700L	753/755
115V AC Interface	AK-M9-115VAC-1	✓					
Frame E Flange Gasket	AK-M9-GASKET1-E4	✓					
Service Connection Board ★	SK-M9-SCB1	✓					
Removable I/O Terminal Block	SK-G9-TB1-S1		✓				
Removable Encoder Terminal Block	SK-G9-TB1-ENC1		✓				
Touch Cover - Converts IP00/Open Type drive to IP20/NEMA/UL Type 1. No wiring space provided.	20-OPT-TC			✓			
Top Hat - Converts IP00/Open Type drive to IP20/NEMA/UL Type 1. Allows for wiring space.	20-OPT-TH			✓			
Auxiliary Control Power Supply	20-24V-AUX1				✓		
PowerFlex 700S Phase II Control with Expanded Cassette	20D-P2-CKE1				✓	✓ ▽	
PowerFlex 700S Phase II Control with Slim Cassette	20D-P2-CKS1				✓		
PowerFlex 700S DriveLogix5730 Phase II Control with Expanded Cassette	20D-DL2-CKE1				✓	✓ ▽	
PowerFlex 700S DriveLogix5730 Phase II Control with Slim Cassette	20D-DL2-CKS1				✓		

★ Provides temporary DPI/HIM connection for NEMA/UL Type 1 and Flange drives with cover removed.

▽ When using PowerFlex 700S control and Expanded Cassette.

## SynchLink Accessories

Description ★	Cat. No.	Used with PowerFlex Drive					
		70	700	700H	700S	700L	753/755
SynchLink Board	20D-P2-SLB0				✓	✓ ▽	
SynchLink Fiber Base Block	1751-SLBA				✓	✓ ▽	
SynchLink 4-port Fiber Splitter Block	1751-SL4SP				✓	✓ ▽	
SynchLink Fiber Bypass Switch Block	1751-SLBP				✓	✓ ▽	
2x3 Meter Fiber Link for Power Monitor/SynchLink	1403-CF003				✓	✓ ▽	
2x5 Meter Fiber Link for Power Monitor/SynchLink	1403-CF005				✓	✓ ▽	
10 Meter Fiber Link for Power Monitor/SynchLink	1403-CF010				✓	✓ ▽	

★ Refer to publication number 1769-SG001 for details on SynchLink.

▽ When using PowerFlex 700S control.

## DriveLogix Option Kits

Description	Cat. No.	Used with PowerFlex Drive					
		70	700	700H	700S	700L	753/755
Logix Expansion board for DriveLogix5730 ♦	20D-DL2-LEB0				✓	✓ ▽	
Industrial Compact Flash 64 MB Memory Card for DriveLogix5730	1784-CF64				✓	✓ ▽	

♦ Requires Expanded Cassette.

▽ When using PowerFlex 700S control.

### DriveLogix I/O Cables

Description	Cat. No.	Used with PowerFlex Drive					
		70	700	700H	700S	700L	753/755
DriveLogix5730 - Compact I/O cable, 3.28 ft. (1 meter), Left Bus Cap ♦ ♣	20D-DL2-CL3				✓	✓ ▽	
DriveLogix5730 - Compact I/O cable, 3.28 ft. (1 meter), Right Bus Cap ♦ ♣	20D-DL2-CR3				✓	✓ ▽	
Logix5000 RS-232 Programming Cable	1756-CP3				✓	✓ ▽	

- ♦ Requires Expanded Cassette.
- ♣ Refer to publication 1769-SG001 for details and selection of Compact I/O.
- ▽ When using PowerFlex 700S control.

### PowerFlex 70 Small Duty Internal Dynamic Brake Resistors

Limited duty resistors mount directly to the back surface of the drive and require no extra panel space. Internal resistors are non-destructive and do not require a resistor overheat external safety circuit.

PowerFlex 70 AC Drive			Small Duty Internal DB Resistor								
Normal Duty ★ kW (Hp)	Heavy Duty ★ kW (Hp)	Min DB Res Ohms ±10%	Cat. No.	Resistance ‡ Ohms ±5%	Continuous Power kW	Max Energy kJ	Max Braking Torque % of ND Motor	Application Type 1		Application Type 2	
								Braking Torque % of ND Motor	Duty Cycle	Braking Torque % of ND Motor	Duty Cycle
<b>200...240 Volt AC Input Drives</b>											
0.37 (0.5)	0.25 (0.33)	33	20AB-DB1-A	62	0.048	8.3	307%	100%	25.9%	150%	17.3%
0.75 (1.0)	0.55 (0.75)	33	20AB-DB1-A	62	0.048	7.3	300%	100%	12.8%	150%	8.5%
1.5 (2.0)	1.1 (1.5)	33	20AB-DB1-B	62	0.028	0.8	160%	100%	3.7%	150%	2.5%
2.2 (3.0)	1.5 (2.0)	33	20AB-DB1-B	62	0.028	0.8	109%	100%	2.5%	109%	2.3%
4.0 (5.0)	3.0 (3.0)	30	20AB-DB1-C	62	0.040	0.8	60%	60%	3.3%	N/A	N/A
5.5 (7.5)	4.0 (5.0)	21	20AB-DB1-D	22	0.036	0.9	117%	100%	1.3%	117%	1.1%
7.5 (10)	5.5 (7.5)	21	20AB-DB1-D	22	0.036	0.9	86%	86%	1.1%	N/A	N/A
<b>400...480 Volt AC Input Drives</b>											
0.37 (0.5)	0.25 (0.33)	68	20AD-DB1-A	115	0.048	8.3	320%	100%	25.9%	150%	17.3%
0.75 (1.0)	0.55 (0.75)	68	20AD-DB1-A	115	0.048	9.0	259%	100%	12.8%	150%	8.5%
1.5 (2.0)	1.1 (1.5)	68	20AD-DB1-A	115	0.048	2.4	243%	100%	6.4%	150%	4.3%
2.2 (3.0)	1.5 (2.0)	68	20AD-DB1-B	115	0.028	0.9	206%	100%	2.5%	150%	1.7%
4.0 (5.0)	3.0 (3.0)	68	20AD-DB1-B	115	0.028	0.9	129%	100%	1.4%	129%	1.1%
5.5 (7.5)	4.0 (5.0)	74	20AD-DB1-C	115	0.04	0.9	94%	94%	1.5%	N/A	N/A
7.5 (10)	5.5 (7.5)	74	20AD-DB1-C	115	0.04	0.9	69%	69%	1.5%	N/A	N/A
11 (15)	7.5 (10)	44	20AD-DB1-D	62	0.036	0.8	87%	87%	0.8%	N/A	N/A
15 (20)	11 (15)	31	20AD-DB1-D	62	0.036	0.8	64%	64%	0.8%	N/A	N/A
<b>500...600 Volt AC Input Drives</b>											
0.37 (0.5)	0.25 (0.33)	117	20AD-DB1-A	115	0.048	8.3	287%	100%	25.9%	150%	17.3%
0.75 (1.0)	0.55 (0.75)	117	20AD-DB1-A	115	0.048	9.0	263%	100%	12.8%	150%	8.5%
1.5 (2.0)	1.1 (1.5)	117	20AD-DB1-A	115	0.048	2.4	243%	100%	6.4%	150%	4.3%
2.2 (3.0)	1.5 (2.0)	117	20AD-DB1-B	115	0.028	0.9	202%	100%	2.5%	150%	1.7%
4.0 (5.0)	3.0 (3.0)	80	20AD-DB1-B	115	0.028	0.9	193%	100%	1.4%	150%	0.9%
5.5 (7.5)	4.0 (5.0)	80	20AD-DB1-C	115	0.04	0.9	147%	100%	1.5%	147%	1.0%
7.5 (10)	5.5 (7.5)	80	20AD-DB1-C	115	0.04	0.9	108%	100%	1.1%	108%	1.0%
11 (15)	7.5 (10)	48	N/A	N/A	N/A	N/A	N/A	N/A	N/A	N/A	N/A
15 (20)	11 (15)	48	N/A	N/A	N/A	N/A	N/A	N/A	N/A	N/A	N/A

- ★ Duty cycle listed is based on full speed to zero speed deceleration. For constant regen at full speed, duty cycle capability is half of what is listed. Application Type 1 represents maximum capability up to 100% braking torque where possible. Application Type 2 represents more than 100% braking torque where possible, up to a maximum of 150%.
- ‡ Always check resistor Ohms against minimum resistance for drive being used.

## PowerFlex 70 Medium Duty External Dynamic Brake Resistors

These resistors provide a larger duty cycle capability than the internal type. Includes an internal thermal switch for use in external safety circuit.

PowerFlex 70 AC Drive			Medium Duty External DB Resistor								
Normal Duty ★ kW (Hp)	Heavy Duty ★ kW (Hp)	Min DB Res Ohms ±10%	Cat. No.	Resistance ‡ Ohms ±5%	Continuous Power kW	Max Energy kJ	Max Braking Torque % of ND Motor	Application Type 1		Application Type 2	
								Braking Torque % of ND Motor	Duty Cycle	Braking Torque % of ND Motor	Duty Cycle
<b>200...240 Volt AC Input Drives</b>											
0.37 (0.5)	0.25 (0.33)	33	AK-R2-091P500	91	0.086	17	293%	100%	46%	150%	31%
0.75 (1.0)	0.55 (0.75)	33	AK-R2-091P500	91	0.086	17	218%	100%	23%	150%	15%
1.5 (2.0)	1.1 (1.5)	33	AK-R2-091P500	91	0.086	17	109%	100%	11%	109%	11%
2.2 (3.0)	1.5 (2.0)	33	AK-R2-047P500	47	0.166	33	144%	100%	15%	144%	11%
4.0 (5.0)	3.0 (3.0)	30	AK-R2-047P500	47	0.166	33	79%	79%	11%	N/A	N/A
5.5 (7.5)	4.0 (5.0)	23	AK-R2-030P1K2	30	0.26	52	90%	90%	10%	N/A	N/A
7.5 (10)	5.5 (7.5)	23	AK-R2-030P1K2	30	0.26	52	66%	66%	10%	N/A	N/A
<b>400...480 Volt AC Input Drives</b>											
0.37 (0.5)	0.25 (0.33)	68	AK-R2-360P500	360	0.086	17	305%	100%	47%	150%	31%
0.75 (1.0)	0.55 (0.75)	68	AK-R2-360P500	360	0.086	17	220%	100%	23%	150%	15%
1.5 (2.0)	1.1 (1.5)	68	AK-R2-360P500	360	0.086	17	110%	100%	12%	110%	11%
2.2 (3.0)	1.5 (2.0)	68	AK-R2-120P1K2	120	0.26	52	197%	100%	24%	150%	16%
4.0 (5.0)	3.0 (3.0)	68	AK-R2-120P1K2	120	0.26	52	124%	100%	13%	124%	10%
5.5 (7.5)	4.0 (5.0)	74	AK-R2-120P1K2	120	0.26	52	90%	90%	10%	N/A	N/A
7.5 (10)	5.5 (7.5)	74	AK-R2-120P1K2	120	0.26	52	66%	66%	10%	N/A	N/A
11 (15) §	7.5 (10) §	44	§	60	0.52	104	90%	90%	10%	N/A	N/A
15 (20) §	11 (15) §	31	§	60	0.52	104	66%	66%	10%	N/A	N/A
<b>500...600 Volt AC Input Drives</b>											
0.37 (0.5)	0.25 (0.33)	117	AK-R2-360P500	360	0.086	17	274%	100%	46%	150%	31%
0.75 (1.0)	0.55 (0.75)	117	AK-R2-360P500	360	0.086	17	251%	100%	23%	150%	15%
1.5 (2.0)	1.1 (1.5)	117	AK-R2-360P500	360	0.086	17	172%	100%	11%	150%	8%
2.2 (3.0)	1.5 (2.0)	117	AK-R2-120P1K2	120	0.26	52	193%	100%	24%	150%	16%
4.0 (5.0)	3.0 (3.0)	80	AK-R2-120P1K2	120	0.26	52	185%	100%	13%	150%	9%
5.5 (7.5)	4.0 (5.0)	80	AK-R2-120P1K2	120	0.26	52	141%	100%	9%	141%	7%
7.5 (10)	5.5 (7.5)	80	AK-R2-120P1K2	120	0.26	52	103%	100%	7%	103%	7%
11 (15) §	7.5 (10) §	48	§	60	0.52	104	141%	100%	9%	141%	7%
15 (20) §	11 (15) §	48	§	60	0.52	104	103%	100%	7%	103%	7%

★ Duty cycle listed is based on full speed to zero speed deceleration. For constant regen at full speed, duty cycle capability is half of what is listed. Application Type 1 represents maximum capability up to 100% braking torque where possible. Application Type 2 represents more than 100% braking torque where possible, up to a maximum of 150%.

‡ Always check resistor Ohms against minimum resistance for drive being used.

§ For 11 and 15 kW (15 and 20 Hp) applications, use two 7.5 kW (10 Hp) size resistors wired in parallel.

### Internal Dynamic Brake Resistor Kits

These resistors have a limited duty cycle. Refer to the PowerFlex Dynamic Braking Resistor Calculator, publication PFLEX-AT001 to determine if an internal resistor will be sufficient for your application. An external resistor may be required.

Drive Input Voltage	Brake Resistance	Frame	Cat. No.	Used with PowerFlex Drive					
	Ω			70	700	700H	700S	700L	753/755
208...240V AC	62	0	20BB-DB1-0		✓			✓	
	62	1 (except 7.5 Hp)	20BB-DB1-1		✓			✓	
	22	1 (7.5 Hp)	20BB-DB2-1		✓			✓	
	22	2	20BB-DB1-2		✓			✓	
380...600V AC	115	0	20BD-DB1-0		✓			✓	
	115	1	20BD-DB1-1		✓			✓	
	68	2	20BD-DB1-2		✓			✓	
	115	1 (1...3 Hp)	20-750-DB1-D1						✓
	62	1 (5...10 Hp)	20-750-DB1-D1A						✓
	62	2	20-750-DB1-D2						✓

### Terminators

Description ‡	Cat. No.	Used with PowerFlex Drive					
		70	700	700H	700S	700L	753/755
for use with 3.7 kW (5 Hp) and below drives	1204-TFA1	✓	✓		✓	✓	✓
for use with 1.5 kW (2 Hp) and up drives	1204-TFB2	✓	✓	✓	✓	✓	✓

‡ For selection information, refer to Appendix A of the Wiring and Grounding Guidelines for Pulse Width Modulated (PWM) AC Drives, publication Drives-IN001.

### Reflected Wave Reduction Modules with Common Mode Choke

Description ‡	Cat. No.	Used with PowerFlex Drive					
		70	700	700H	700S	700L	753/755
17A with Common Mode Choke	1204-RWC-17-A	✓	✓	✓	✓		✓

‡ For selection information, refer to Appendix A of the Wiring and Grounding Guidelines for Pulse Width Modulated (PWM) AC Drives, publication Drives-IN001.

## Reflected Wave Reduction Modules

Voltage	ND kW	ND Hp	Cat. No.	Used with PowerFlex Drive					
				70	700	700H	700S	700L	753/755
380...480V AC	4	5	1321-RWR8-DP	✓	✓		✓		✓
	5.5	7.5	1321-RWR12-DP	✓	✓		✓		✓
	7.5	10	1321-RWR18-DP	✓	✓		✓		✓
	11	15	1321-RWR25-DP	✓	✓		✓		✓
	15	20	1321-RWR35-DP	✓	✓		✓		✓
	18.5	25	1321-RWR35-DP	✓	✓		✓		✓
	22	30	1321-RWR45-DP	✓	✓		✓		✓
	30	40	1321-RWR55-DP	✓	✓		✓		✓
	37	50	1321-RWR80-DP	✓	✓		✓		✓
	45	60	1321-RWR80-DP		✓		✓		✓
	55	75	1321-RWR100-DP		✓		✓		✓
	75	100	1321-RWR130-DP		✓		✓		✓
			1321-RWR160-DP				✓		
	90	125	1321-RWR160-DP		✓		✓		✓
	110	150	1321-RWR200-DP		✓		✓		✓
	149	200	1321-RWR250-DP		✓	✓	✓		✓
			1321-RWR320-DP				✓		
	187	250	1321-RWR320-DP		✓	✓	✓		✓
500...600V AC	4	5	1321-RWR8-EP	✓	✓		✓		✓
	5.5	7.5	1321-RWR8-EP				✓		
			1321-RWR12-EP	✓	✓				✓
	7.5	10	1321-RWR12-EP	✓	✓		✓		
			1321-RWR18-EP						✓
	11	15	1321-RWR18-EP	✓	✓		✓		
			1321-RWR25-EP						✓
	15	20	1321-RWR25-EP	✓	✓		✓		
			1321-RWR35-EP						✓
	18.5	25	1321-RWR25-EP				✓		
			1321-RWR35-EP	✓	✓				✓
	22	30	1321-RWR35-EP	✓	✓		✓		
			1321-RWR45-EP						✓
	30	40	1321-RWR45-EP	✓	✓		✓		
			1321-RWR55-EP						✓
	37	50	1321-RWR55-EP	✓	✓		✓		
			1321-RWR80-EP						✓
	45	60	1321-RWR80-EP		✓		✓		✓
			1321-RWR100-EP						✓
	55	75	1321-RWR80-EP		✓		✓		
			1321-RWR100-EP						✓
	75	100	1321-RWR100-EP		✓		✓		
			1321-RWR130-EP						✓
	90	125	1321-RWR130-EP		✓		✓		
			1321-RWR160-EP						✓
	110	150	1321-RWR160-EP		✓		✓		
			1321-RWR200-EP				✓		✓
	149	200	1321-RWR200-EP				✓		
			1321-RWR250-EP						✓



Isolation Transformers - IP32, NEMA/UL Type 3R Standalone, 4...6% Nominal Impedance

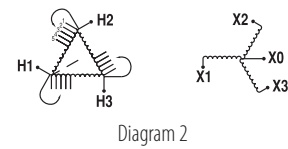
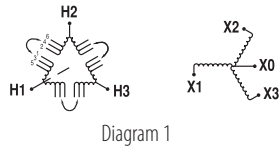

Motor Rating		Wiring Diagram	240V, 60 Hz, Three-Phase Primary & 240V Secondary ★	460V, 60 Hz, Three-Phase Primary & 460V Secondary	575V, 60 Hz, Three-Phase Primary & 575V Secondary ★	Used with PowerFlex Drive					
kW	Hp		Cat. No.	Cat. No.	Cat. No.	70	700	700H	700S	700L	753/755
0.25	0.33	1	1321-3TW005-AA	1321-3TW005-BB	-	✓	✓		✓		
0.37	0.5	1	1321-3TW005-AA	1321-3TW005-BB	1321-3TW005-CC	✓	✓		✓		
0.55	0.75	1	1321-3TW005-AA	1321-3TW005-BB	-	✓	✓		✓		
0.75	1	1	1321-3TW005-AA	1321-3TW005-BB	1321-3TW005-CC	✓	✓		✓		✓
1.1	1.5	1	1321-3TW005-AA	1321-3TW005-BB	-	✓	✓		✓		
1.5	2	1	1321-3TW005-AA	1321-3TW005-BB	1321-3TW005-CC	✓	✓		✓		✓
2.2	3	1	1321-3TW005-AA	1321-3TW005-BB	1321-3TW005-CC	✓	✓		✓		✓
22	30	2	1321-3TW040-AA	1321-3TW040-BB	1321-3TW040-CC	✓	✓		✓		✓
30	40	2	1321-3TW051-AA	1321-3TW051-BB	1321-3TW051-CC	✓	✓		✓		✓
37	50	2	1321-3TH063-AA	1321-3TH063-BB	1321-3TH063-CC	✓	✓		✓		✓
45	60	2	1321-3TH075-AA	1321-3TH075-BB	1321-3TH075-CC		✓		✓		✓
55	75	2	1321-3TH093-AA	1321-3TH093-BB	1321-3TH093-CC		✓		✓		✓
75	100	2	-	1321-3TH118-BB	1321-3TH118-CC		✓		✓		✓
90	125	2	-	1321-3TH145-BB	1321-3TH145-CC		✓		✓		✓
110	150	2	-	1321-3TH175-BB	1321-3TH175-CC		✓	✓	✓		✓
149	200	2	-	1321-3TH220-BB	1321-3TH220-CC		✓	✓	✓		✓
187	250	2	-	1321-3TH275-BB	1321-3TH275-CC		✓	✓			✓
224	300	2	-	1321-3TH330-BB	1321-3TH330-CC		✓	✓			✓
224	300	1	-	-	1321-3TH330-CC						✓
261	350	1	-	1321-3TH440-BB	1321-3TH440-CC		✓	✓			✓
298	400	1	-	1321-3TH440-BB	1321-3TH440-CC		✓	✓			
298	400	1	-	1321-3TH440-BB	1321-3TH550-CC						✓
336	450	1	-	1321-3TH550-BB	1321-3TH550-CC		✓	✓			✓
373	500	1	-	1321-3TH550-BB	1321-3TH550-CC		✓	✓			
373	500	1	-	1321-3TH550-BB	1321-3TH660-CC						✓
410	550	1	-	-	1321-3TH660-CC						✓
448	600	1	-	1321-3TH660-BB	1321-3TH660-CC		✓	✓			
448	600	1	-	1321-3TH660-BB	1321-3TH770-CC						✓
485	650	1	-	-	1321-3TH770-CC		✓	✓			
522	700	1	-	1321-3TH770-BB	1321-3TH770-CC		✓	✓			✓
597	800	1	-	1321-3TH880-BB	1321-3TH880-CC						✓
671	900	-	-	900 kVA ‡	950 kVA ‡						✓
709	950	-	-	-	1000 kVA ‡						✓
746	1000	-	-	1000 kVA ‡	1100 kVA ‡						✓
821	1100	-	-	1200 kVA ‡	-						✓
895	1200	-	-	-	1200 kVA ‡						✓
933	1250	-	-	1200 kVA ‡	-						✓
1007	1350	-	-	1300 kVA ‡	-						✓
1119	1500	-	-	1500 kVA ‡	1500 kVA ‡						✓
1492	2000	-	-	2000 kVA ‡	-						✓

★ Not applicable for the PowerFlex 755.

‡ 1321 Isolation Transformer solution is not available. Approximate drive kVA is listed.

## Input and Output Reactors - 200...240V, 50/60 Hz, Three-Phase, 3% Impedance

kW	Hp	Duty	Input Line Reactor ‡		Output Reactor ‡		Used with PowerFlex Drive					
			IPO0 (Open Style)	IP11 (NEMA/UL Type 1)	IPO0 (Open Style)	IP11 (NEMA/UL Type 1)	70	700	700H	700S	700L	753/755
0.25	0.33	Heavy	1321-3R2-D	1321-3RA2-D	1321-3R2-D	1321-3RA2-D	✓	✓		✓		
0.37	0.5	Normal	1321-3R2-D	1321-3RA2-D	1321-3R2-D	1321-3RA2-D	✓	✓		✓		
0.55	0.75	Heavy	1321-3R4-A	1321-3RA4-A	1321-3R4-A	1321-3RA4-A	✓	✓		✓		
0.75	1	Normal	1321-3R4-A	1321-3RA4-A	1321-3R4-A	1321-3RA4-A	✓	✓		✓		
1.1	1.5	Heavy	1321-3R8-B	1321-3RA8-B	1321-3R8-A	1321-3RA8-A	✓	✓		✓		
1.5	2	Normal	1321-3R8-A	1321-3RA8-A	1321-3R8-A	1321-3RA8-A	✓	✓		✓		
		Heavy	1321-3R8-A	1321-3RA8-A	1321-3R12-A	1321-3RA12-A	✓	✓		✓		
2.2	3	Normal	1321-3R12-A	1321-3RA12-A	1321-3R12-A	1321-3RA12-A	✓	✓		✓		
		Heavy	1321-3R12-A	1321-3RA12-A	1321-3R18-A	1321-3RA18-A	✓	✓		✓		
4	5	Normal	1321-3R18-A	1321-3RA18-A	1321-3R18-A	1321-3RA18-A	✓	✓		✓		
		Heavy	1321-3R18-A	1321-3RA18-A	1321-3R25-A	1321-3RA25-A	✓	✓		✓		
5.5	7.5	Normal	1321-3R25-A	1321-3RA25-A	1321-3R25-A	1321-3RA25-A	✓	✓		✓		
		Heavy	1321-3R25-A	1321-3RA25-A	1321-3R35-A	1321-3RA35-A	✓	✓		✓		
7.5	10	Normal	1321-3R35-A	1321-3RA35-A	1321-3R35-A	1321-3RA35-A	✓	✓		✓		
		Heavy	1321-3R35-A	1321-3RA35-A	1321-3R45-A	1321-3RA45-A	✓	✓		✓		
11	15	Normal	1321-3R45-A	1321-3RA45-A	1321-3R45-A	1321-3RA45-A	✓	✓		✓		
		Heavy	1321-3R45-A	1321-3RA45-A	1321-3R55-A	1321-3RA55-A	✓	✓		✓		
15	20	Normal	1321-3R55-A	1321-3RA55-A	1321-3R55-A	1321-3RA55-A	✓	✓		✓		
		Heavy	1321-3R55-A	1321-3RA55-A	1321-3R80-A	1321-3RA80-A	✓	✓		✓		
18.5	25	Normal	1321-3R80-A	1321-3RA80-A	1321-3R80-A	1321-3RA80-A	✓	✓		✓		
		Heavy	1321-3R80-A	1321-3RA80-A	1321-3R80-A	1321-3RA80-A		✓		✓		
22	30	Normal	1321-3R80-A	1321-3RA80-A	1321-3R80-A	1321-3RA80-A		✓		✓		
		Heavy	1321-3R80-A	1321-3RA80-A	1321-3R80-A	1321-3RA80-A		✓		✓		
30	40	Normal	1321-3R100-A	1321-3RA100-A	1321-3R100-A	1321-3RA100-A		✓		✓		
		Heavy	1321-3R100-A	1321-3RA100-A	1321-3R100-A	1321-3RA100-A		✓		✓		
37	50	Normal	1321-3R130-A	1321-3RA130-A	1321-3R130-A	1321-3RA130-A		✓		✓		
		Heavy	1321-3R130-A	1321-3RA130-A	1321-3R130-A	1321-3RA130-A		✓		✓		
45	60	Normal	1321-3R160-A	1321-3RA160-A	1321-3R160-A	1321-3RA160-A		✓		✓		
		Heavy	1321-3R160-A	1321-3RA160-A	1321-3R160-A	1321-3RA160-A		✓		✓		
55	75	Normal	1321-3R200-A	1321-3RA200-A	1321-3R200-A	1321-3RA200-A		✓		✓		
		Heavy	1321-3R200-A	1321-3RA200-A	1321-3R200-A	1321-3RA200-A		✓		✓		
75	100	Normal	1321-3RB250-A	1321-3RAB250-A	1321-3RB250-A	1321-3RAB250-A		✓		✓		

‡ Input line reactors were sized based on the NEC fundamental motor amps. Output line reactors were sized based on the VFD rated output currents.

**Input and Output Reactors - 200...240V, 50/60 Hz, Three-Phase, 5% Impedance**

kW	Hp	Duty	Input Line Reactor ‡		Output Reactor ‡		Used with PowerFlex Drive					
			IP00 (Open Style)	IP11 (NEMA/UL Type 1)	IP00 (Open Style)	IP11 (NEMA/UL Type 1)	70	700	700H	700S	700L	753/755
0.25	0.33	Heavy	1321-3R2-A	1321-3RA2-A	1321-3R2-A	1321-3RA2-A	✓	✓		✓		
0.37	0.5	Normal	1321-3R2-A	1321-3RA2-A	1321-3R2-A	1321-3RA2-A	✓	✓		✓		
0.55	0.75	Heavy	1321-3R4-B	1321-3RA4-B	1321-3R4-B	1321-3RA4-B	✓	✓		✓		
0.75	1	Normal	1321-3R4-B	1321-3RA4-B	1321-3R4-B	1321-3RA4-B	✓	✓		✓		
1.1	1.5	Heavy	1321-3R8-B	1321-3RA8-B	1321-3R8-B	1321-3RA8-B	✓	✓		✓		
1.5	2	Normal	1321-3R8-B	1321-3RA8-B	1321-3R8-B	1321-3RA8-B	✓	✓		✓		
		Heavy	1321-3R8-B	1321-3RA8-B	1321-3R12-B	1321-3RA12-B	✓	✓		✓		
2.2	3	Normal	1321-3R12-B	1321-3RA12-B	1321-3R12-B	1321-3RA12-B	✓	✓		✓		
		Heavy	1321-3R12-B	1321-3RA12-B	1321-3R18-B	1321-3RA18-B	✓	✓		✓		
4	5	Normal	1321-3R18-B	1321-3RA18-B	1321-3R18-B	1321-3RA18-B	✓	✓		✓		
		Heavy	1321-3R18-B	1321-3RA18-B	1321-3R25-B	1321-3RA25-B	✓	✓		✓		
5.5	7.5	Normal	1321-3R25-B	1321-3RA25-B	1321-3R25-B	1321-3RA25-B	✓	✓		✓		
		Heavy	1321-3R25-B	1321-3RA25-B	1321-3R35-B	1321-3RA35-B	✓	✓		✓		
7.5	10	Normal	1321-3R35-B	1321-3RA35-B	1321-3R35-B	1321-3RA35-B	✓	✓		✓		
		Heavy	1321-3R35-B	1321-3RA35-B	1321-3R45-B	1321-3RA45-B	✓	✓		✓		
11	15	Normal	1321-3R45-B	1321-3RA45-B	1321-3R45-B	1321-3RA45-B	✓	✓		✓		
		Heavy	1321-3R45-B	1321-3RA45-B	1321-3R55-B	1321-3RA55-B	✓	✓		✓		
15	20	Normal	1321-3R55-B	1321-3RA55-B	1321-3R55-B	1321-3RA55-B	✓	✓		✓		
		Heavy	1321-3R55-B	1321-3RA55-B	1321-3R80-B	1321-3RA80-B	✓	✓		✓		
18.5	25	Normal	1321-3R80-B	1321-3RA80-B	1321-3R80-B	1321-3RA80-B		✓		✓		
		Heavy	1321-3R80-B	1321-3RA80-B	1321-3R80-B	1321-3RA80-B		✓		✓		
22	30	Normal	1321-3R80-B	1321-3RA80-B	1321-3R80-B	1321-3RA80-B		✓		✓		
		Heavy	1321-3R80-B	1321-3RA80-B	1321-3R80-B	1321-3RA80-B		✓		✓		
30	40	Normal	1321-3R100-B	1321-3RA100-B	1321-3R100-B	1321-3RA100-B		✓		✓		
		Heavy	1321-3R100-B	1321-3RA100-B	1321-3R100-B	1321-3RA100-B		✓		✓		
37	50	Normal	1321-3R130-B	1321-3RA130-B	1321-3R130-B	1321-3RA130-B		✓		✓		
		Heavy	1321-3R130-B	1321-3RA130-B	1321-3R130-B	1321-3RA130-B		✓		✓		
45	60	Normal	1321-3R160-B	1321-3RA160-B	1321-3R160-B	1321-3RA160-B		✓		✓		
		Heavy	1321-3R160-B	1321-3RA160-B	1321-3R160-B	1321-3RA160-B		✓		✓		
55	75	Normal	1321-3R200-B	1321-3RA200-B	1321-3R200-B	1321-3RA200-B		✓		✓		
		Heavy	1321-3R200-B	1321-3RA200-B	1321-3R200-B	1321-3RA200-B		✓		✓		
75	100	Normal	1321-3RB250-B	1321-3RAB250-B	1321-3RB250-B	1321-3RAB250-B		✓		✓		

‡ Input line reactors were sized based on the NEC fundamental motor amps. Output line reactors were sized based on the VFD rated output currents.

## Input and Output Reactors - 380...480V, 50/60 Hz, Three-Phase, 3% Impedance

kW	Hp	Duty	Input Line Reactor ‡		Output Reactor ‡		Used with PowerFlex Drive					
			IPO0 (Open Style)	IP11 (NEMA/UL Type 1)	IPO0 (Open Style)	IP11 (NEMA/UL Type 1)	70	700	700H	700S	700L	753/755
0.25	0.33	Heavy	1321-3R1-C	1321-3RA1-C	1321-3R2-B	1321-3RA2-B	✓	✓		✓		
0.37	0.5	Normal	1321-3R1-C	1321-3RA1-C	1321-3R2-B	1321-3RA2-B	✓	✓		✓		
0.55	0.75	Heavy	1321-3R2-A	1321-3RA2-A	1321-3R2-A	1321-3RA2-A	✓	✓		✓		
0.75	1	Normal	1321-3R2-A	1321-3RA2-A	1321-3R2-A	1321-3RA2-A	✓	✓		✓		✓
1.1	1.5	Heavy	1321-3R4-C	1321-3RA4-C	1321-3R4-B	1321-3RA4-B	✓	✓		✓		✓
1.5	2	Normal	1321-3R4-B	1321-3RA4-B	1321-3R4-B	1321-3RA4-B	✓	✓		✓		✓
		Heavy	1321-3R4-B	1321-3RA4-B	1321-3R8-C	1321-3RA8-C	✓	✓		✓		✓
2.2	3	Normal	1321-3R8-C	1321-3RA8-C	1321-3R8-C	1321-3RA8-C	✓	✓		✓		✓
		Heavy	1321-3R8-C	1321-3RA8-C	1321-3R8-B	1321-3RA8-B	✓	✓		✓		✓
4	5	Normal	1321-3R8-B	1321-3RA8-B	1321-3R8-B	1321-3RA8-B	✓	✓		✓		✓
		Heavy	1321-3R8-B	1321-3RA8-B	1321-3R12-B	1321-3RA12-B	✓	✓		✓		✓
5.5	7.5	Normal	1321-3R12-B	1321-3RA12-B	1321-3R12-B	1321-3RA12-B	✓	✓		✓		✓
		Heavy	1321-3R12-B	1321-3RA12-B	1321-3R18-B	1321-3RA18-B	✓	✓		✓		✓
7.5	10	Normal	1321-3R18-B	1321-3RA18-B	1321-3R18-B	1321-3RA18-B	✓	✓		✓		✓
		Heavy	1321-3R18-B	1321-3RA18-B	1321-3R25-B	1321-3RA25-B	✓	✓		✓		✓
11	15	Normal	1321-3R25-B	1321-3RA25-B	1321-3R25-B	1321-3RA25-B	✓	✓		✓		✓
		Heavy	1321-3R25-B	1321-3RA25-B	1321-3R25-B	1321-3RA25-B	✓	✓		✓		✓
15	20	Normal	1321-3R35-B	1321-3RA35-B	1321-3R25-B	1321-3RA25-B	✓	✓		✓		✓
		Heavy	1321-3R35-B	1321-3RA35-B	1321-3R35-B	1321-3RA35-B	✓	✓		✓		✓
18.5	25	Normal	1321-3R35-B	1321-3RA35-B	1321-3R35-B	1321-3RA35-B	✓	✓		✓		✓
		Heavy	1321-3R35-B	1321-3RA35-B	1321-3R45-B	1321-3RA45-B	✓	✓		✓		✓
22	30	Normal	1321-3R45-B	1321-3RA45-B	1321-3R45-B	1321-3RA45-B	✓	✓		✓		✓
		Heavy	1321-3R45-B	1321-3RA45-B	1321-3R55-B	1321-3RA55-B	✓	✓		✓		✓
30	40	Normal	1321-3R55-B	1321-3RA55-B	1321-3R55-B	1321-3RA55-B	✓	✓		✓		✓
		Heavy	1321-3R55-B	1321-3RA55-B	1321-3R80-B	1321-3RA80-B	✓	✓		✓		✓
37	50	Normal	1321-3R80-B	1321-3RA80-B	1321-3R80-B	1321-3RA80-B	✓	✓		✓		✓
		Heavy	1321-3R80-B	1321-3RA80-B	1321-3R80-B	1321-3RA80-B		✓		✓		✓
45	60	Normal/Heavy	1321-3R80-B	1321-3RA80-B	1321-3R80-B	1321-3RA80-B		✓		✓		✓
55	75	Normal/Heavy	1321-3R100-B	1321-3RA100-B	1321-3R100-B	1321-3RA100-B		✓		✓		✓
75	100	Normal/Heavy	1321-3R130-B	1321-3RA130-B	1321-3R130-B	1321-3RA130-B		✓		✓		✓
90	125	Normal/Heavy	1321-3R160-B	1321-3RA160-B	1321-3R160-B	1321-3RA160-B		✓		✓		✓
110	150	Normal	1321-3R200-B	1321-3RA200-B	1321-3R200-C	1321-3RA200-C		✓	✓	✓		✓
		Heavy	1321-3R200-B	1321-3RA200-B	1321-3R200-C	1321-3RA200-C		✓		✓		✓
		Heavy	–	–	1321-3R200-B	1321-3RA200-B			✓			
–	200	Normal/Heavy	1321-3RB250-B	1321-3RAB250-B	1321-3RB250-B	1321-3RAB250-B						✓
132	–	Normal/Heavy	1321-3RB250-B	1321-3RAB250-B	1321-3RB250-B	1321-3RAB250-B						✓
149	200	Normal	1321-3RB250-B	1321-3RAB250-B	1321-3RB250-B	1321-3RAB250-B		✓	✓	✓		
		Heavy	1321-3RB250-B	1321-3RAB250-B	1321-3RB250-B	1321-3RAB250-B		✓	✓	✓		
160	250	Normal/Heavy	1321-3RB320-B	1321-3RAB320-B	1321-3RB320-B	1321-3RAB320-B						✓
187	250	Normal/Heavy	1321-3RB320-B	1321-3RAB320-B	1321-3RB320-B	1321-3RAB320-B		✓	✓			
200	300	Normal	1321-3RB400-B	1321-3RAB400-B	1321-3RB400-B	1321-3RAB400-B		✓	✓			✓
		Heavy	1321-3RB400-B	1321-3RAB400-B	1321-3RB400-B	1321-3RAB400-B		✓	✓			✓
–	350	Normal/Heavy	1321-3R500-B	1321-3RA500-B	1321-3R500-B	1321-3RA500-B						✓
250	–	Normal/Heavy	1321-3R500-B	1321-3RA500-B	1321-3R500-B	1321-3RA500-B						✓
261	350	Normal	1321-3RB400-B	1321-3RAB400-B	1321-3RB400-B	1321-3RAB400-B		✓				
		Heavy	1321-3RB400-B	1321-3RAB400-B	1321-3RB400-B	1321-3RAB400-B		✓	✓			
		Normal	–	–	1321-3R500-B	1321-3RA500-B			✓			

continued

**Input and Output Reactors - 380...480V, 50/60 Hz, Three-Phase, 3% Impedance (continued)**

kW	Hp	Duty ♦	Input Line Reactor ‡		Output Reactor ‡		Used with PowerFlex Drive					
			IPO0 (Open Style)	IP11 (NEMA/UL Type 1)	IPO0 (Open Style)	IP11 (NEMA/UL Type 1)	70	700	700H	700S	700L	753/755
–	400	Light/Normal/Heavy	1321-3R500-B	1321-3RA500-B	1321-3R500-B	1321-3RA500-B						✓
280	400	Normal/Heavy	1321-3R500-B	1321-3RA500-B	1321-3R500-B	1321-3RA500-B	✓					
315	–	Light/Normal/Heavy	1321-3R600-B	1321-3RA600-B	1321-3R600-B	1321-3RA600-B						✓
–	450	Light/Normal/Heavy	1321-3R600-B	1321-3RA600-B	1321-3R600-B	1321-3RA600-B						✓
336	450	Normal/Heavy	1321-3R500-B	1321-3RA500-B	1321-3R500-B	1321-3RA500-B	✓	✓				
355	–	Light/Normal/Heavy	1321-3R750-B	1321-3RA750-B	1321-3R750-B	1321-3RA750-B						✓
–	500	Light	1321-3R600-B	1321-3RA600-B	1321-3R600-B	1321-3RA600-B						✓
		Normal/Heavy	1321-3R750-B	1321-3RA750-B	1321-3R750-B	1321-3RA750-B						✓
373	500	Normal/Heavy	1321-3R600-B	1321-3RA600-B	1321-3R600-B	1321-3RA600-B	✓	✓				
400	–	Light/Heavy	1321-3R750-B	1321-3RA750-B	1321-3R750-B	1321-3RA750-B						✓
		Normal	1321-3R850-B	1321-3RA850-B	1321-3R850-B	1321-3RA850-B						✓
–	600	Light/Normal/Heavy	1321-3R750-B	1321-3RA750-B	1321-3R750-B	1321-3RA750-B						✓
448	600	Normal	1321-3R750-B	1321-3RA750-B	1321-3R750-B	1321-3RA750-B	✓	✓				
		Heavy	–	–	1321-3R750-B	1321-3RA750-B			✓			
		Heavy	1321-3R750-B	1321-3RA750-B	1321-3R600-B	1321-3RA600-B	✓					
450	–	Light	1321-3R850-B	1321-3RA850-B	1321-3R850-B	1321-3RA850-B					✓	
–	650	Light	1321-3R850-B	1321-3RA850-B	1321-3R850-B	1321-3RA850-B						✓
		Normal	1321-3R750-B	1321-3RA750-B	1321-3R750-B	1321-3RA750-B						✓
–	700	Light/Normal/Heavy	1321-3R850-B	1321-3RA850-B	1321-3R850-B	1321-3RA850-B						✓
522	700	Normal	1321-3R850-B	1321-3RA850-B	1321-3R850-B	1321-3RA850-B	✓					
		Normal/Heavy	–	–	1321-3RB400-B	1321-3RA400-B			✓ §			
–	750	Heavy	1321-3R850-B	1321-3RA850-B	1321-3R850-B	1321-3RA850-B						✓
500	–	Normal/Heavy	1321-3R1000-B	1321-3RA1000-B	1321-3R1000-B	1321-3RA1000-B						✓
500	800	Normal/Heavy	–	–	1321-3R500-B	1321-3RA500-B			✓ §			
–	800	Light/Normal/Heavy	1321-3R1000-B	1321-3RA1000-B	1321-3R1000-B	1321-3RA1000-B						✓
560	–	Light/Normal/Heavy	1321-3R600-B	1321-3RA600-B	1321-3R600-B	1321-3RA600-B						✓ §
630	900	Light/Normal/Heavy	1321-3R600-B	1321-3RA600-B	1321-3R600-B	1321-3RA600-B						✓ §
		Normal	–	–	1321-3R500-B	1321-3RA500-B			✓ §			
		Heavy	–	–	1321-3R600-B	1321-3RA600-B			✓ §			
710	1000	Light/Normal/Heavy	1321-3R600-B	1321-3RA600-B	1321-3R600-B	1321-3RA600-B						✓ §
746	1000	Normal	–	–	1321-3R600-B	1321-3RA600-B			✓ §			
		Heavy	–	–	1321-3R750-B	1321-3RA750-B			✓ §			
800	1100	Light/Normal	1321-3R750-B	1321-3RA750-B	1321-3R750-B	1321-3RA750-B						✓ §
850	–	Light/Normal	1321-3R750-B	1321-3RA750-B	1321-3R750-B	1321-3RA750-B						✓ §
895	1200	Normal	–	–	1321-3R750-B	1321-3RA750-B			✓ §			
900	–	Light	1321-3R850-B	1321-3RA850-B	1321-3R850-B	1321-3RA850-B						✓ §
–	1250	Light/Normal	1321-3R750-B	1321-3RA750-B	1321-3R750-B	1321-3RA750-B						✓ §
933	1250	Normal	–	–	1321-3R750-B	1321-3RA750-B			✓ §			
–	1350	Light	1321-3R850-B	1321-3RA850-B	1321-3R850-B	1321-3RA850-B						✓ §
–	1500	Light	1321-3R850-B	1321-3RA850-B	1321-3R850-B	1321-3RA850-B						✓ ♣
1000	–	Light	1321-3R850-B	1321-3RA850-B	1321-3R850-B	1321-3RA850-B						✓ ♣
–	2000	Light	1321-3R850-B	1321-3RA850-B	1321-3R850-B	1321-3RA850-B						✓ ♣
1400	–	Light	1321-3R850-B	1321-3RA850-B	1321-3R850-B	1321-3RA850-B						✓ ♣

‡ Input line reactors were sized based on the NEC fundamental motor amps (PowerFlex 700H has an integral input reactor). Output line reactors were sized based on the VFD rated output currents.

§ Requires two reactors wired in parallel.

♣ Requires three reactors wired in parallel.

♦ Light Duty refers to PowerFlex 755 drives only.

## Input and Output Reactors - 380...480V, 50/60 Hz, Three-Phase, 5% Impedance

kW	Hp	Duty	Input Line Reactor ‡		Output Reactor ‡		Used with PowerFlex Drive					
			IPO0 (Open Style)	IP11 (NEMA/UL Type 1)	IPO0 (Open Style)	IP11 (NEMA/UL Type 1)	70	700	700H	700S	700L	753/755
0.25	0.33	Heavy	1321-3R1-B	1321-3RA1-B	1321-3R2-C	1321-3RA2-C	✓	✓		✓		
0.37	0.5	Normal	1321-3R1-B	1321-3RA1-B	1321-3R2-C	1321-3RA2-C	✓	✓		✓		
0.55	0.75	Heavy	1321-3R2-C	1321-3RA2-C	1321-3R2-B	1321-3RA2-B	✓	✓		✓		
0.75	1	Normal	1321-3R2-B	1321-3RA2-B	1321-3R2-B	1321-3RA2-B	✓	✓		✓		✓
1.1	1.5	Heavy	1321-3R4-D	1321-3RA4-D	1321-3R4-D	1321-3RA4-D	✓	✓		✓		✓
1.5	2	Normal	1321-3R4-D	1321-3RA4-D	1321-3R4-D	1321-3RA4-D	✓	✓		✓		✓
		Heavy	1321-3R4-D	1321-3RA4-D	1321-3R8-D	1321-3RA8-D	✓	✓		✓		✓
2.2	3	Normal	1321-3R8-D	1321-3RA8-D	1321-3R8-D	1321-3RA8-D	✓	✓		✓		✓
		Heavy	1321-3R8-D	1321-3RA8-D	1321-3R8-C	1321-3RA8-C	✓	✓		✓		✓
4	5	Normal	1321-3R8-C	1321-3RA8-C	1321-3R8-C	1321-3RA8-C	✓	✓		✓		✓
		Heavy	1321-3R8-C	1321-3RA8-C	1321-3R12-C	1321-3RA12-C	✓	✓		✓		✓
5.5	7.5	Normal	1321-3R12-C	1321-3RA12-C	1321-3R12-C	1321-3RA12-C	✓	✓		✓		✓
		Heavy	1321-3R12-C	1321-3RA12-C	1321-3R18-C	1321-3RA18-C	✓	✓		✓		✓
7.5	10	Normal	1321-3R18-C	1321-3RA18-C	1321-3R18-C	1321-3RA18-C	✓	✓		✓		✓
		Heavy	1321-3R18-C	1321-3RA18-C	1321-3R25-C	1321-3RA25-C	✓	✓		✓		✓
11	15	Normal/Heavy	1321-3R25-C	1321-3RA25-C	1321-3R25-C	1321-3RA25-C	✓	✓		✓		✓
15	20	Normal	1321-3R35-C	1321-3RA35-C	1321-3R25-C	1321-3RA25-C	✓	✓		✓		✓
		Heavy	1321-3R35-C	1321-3RA35-C	1321-3R35-C	1321-3RA35-C	✓	✓		✓		✓
18.5	25	Normal	1321-3R35-C	1321-3RA35-C	1321-3R35-C	1321-3RA35-C	✓	✓		✓		✓
		Heavy	1321-3R35-C	1321-3RA35-C	1321-3R45-C	1321-3RA45-C	✓	✓		✓		✓
22	30	Normal	1321-3R45-C	1321-3RA45-C	1321-3R45-C	1321-3RA45-C	✓	✓		✓		✓
		Heavy	1321-3R45-C	1321-3RA45-C	1321-3R55-C	1321-3RA55-C	✓	✓		✓		✓
30	40	Normal	1321-3R55-C	1321-3RA55-C	1321-3R55-C	1321-3RA55-C	✓	✓		✓		✓
		Heavy	1321-3R55-C	1321-3RA55-C	1321-3R80-C	1321-3RA80-C	✓	✓		✓		✓
37	50	Normal	1321-3R80-C	1321-3RA80-C	1321-3R80-C	1321-3RA80-C	✓	✓		✓		✓
		Heavy	1321-3R80-C	1321-3RA80-C	1321-3R80-C	1321-3RA80-C		✓		✓		✓
45	60	Normal/Heavy	1321-3R80-C	1321-3RA80-C	1321-3R80-C	1321-3RA80-C		✓		✓		✓
55	75	Normal/Heavy	1321-3R100-C	1321-3RA100-C	1321-3R100-C	1321-3RA100-C		✓		✓		✓
75	100	Normal/Heavy	1321-3R130-C	1321-3RA130-C	1321-3R130-C	1321-3RA130-C		✓		✓		✓
90	125	Normal/Heavy	1321-3R160-C	1321-3RA160-C	1321-3R160-C	1321-3RA160-C		✓		✓		✓
110	150	Normal	1321-3R200-C	1321-3RA200-C	1321-3R200-C	1321-3RA200-C		✓		✓		✓
		Heavy	1321-3R200-C	1321-3RA200-C	1321-3R200-C	1321-3RA200-C		✓	✓	✓		✓
		Heavy	1321-3RB250-C	1321-3RAB250-C	1321-3RB250-C	1321-3RAB250-C			✓	✓ ♣		
–	200	Normal/Heavy	1321-3RB250-C	1321-3RAB250-C	1321-3RB250-C	1321-3RAB250-C						✓
132	–	Normal/Heavy	1321-3RB320-C	1321-3RAB320-C	1321-3RB320-C	1321-3RAB320-C						✓
149	200	Normal	1321-3RB250-C	1321-3RAB250-C	1321-3RB250-C	1321-3RAB250-C		✓		✓ Δ		
		Heavy	1321-3RB250-C	1321-3RAB250-C	1321-3RB250-C	1321-3RAB250-C		✓	✓	✓		
160	250	Normal/Heavy	1321-3RB320-C	1321-3RAB320-C	1321-3RB320-C	1321-3RAB320-C						✓
187	250	Normal/Heavy	1321-3RB320-C	1321-3RAB320-C	1321-3RB320-C	1321-3RAB320-C		✓	✓			
–	300	Normal/Heavy	1321-3RB400-C	1321-3RAB400-C	1321-3RB400-C	1321-3RAB400-C						✓
200	–	Normal/Heavy	1321-3RB400-C	1321-3RAB400-C	1321-3RB400-C	1321-3RAB400-C						✓
224	300	Normal/Heavy	1321-3RB400-C	1321-3RAB400-C	1321-3RB400-C	1321-3RAB400-C		✓	✓			
–	350	Normal/Heavy	1321-3R500-C	1321-3RA500-C	1321-3R500-C	1321-3RA500-C						✓
250	–	Normal/Heavy	1321-3R500-C	1321-3RA500-C	1321-3R500-C	1321-3RA500-C						✓
261	350	Normal	1321-3R500-C	1321-3RA500-C	1321-3RB400-C	1321-3RAB400-C		✓				
		Normal	1321-3R500-C	1321-3RA500-C	1321-3R500-C	1321-3RA500-C			✓			
		Heavy	1321-3R500-C	1321-3RA500-C	1321-3RB400-C	1321-3RAB400-C		✓	✓			

continued

‡ Input line reactors were sized based on the NEC fundamental motor amps (PowerFlex 700H has an integral input reactor). Output line reactors were sized based on the VFD rated output currents.

♣ For use with 300A PowerFlex 700S.

Δ For use with 248A and 261A PowerFlex 700S

**Input and Output Reactors - 380...480V, 50/60 Hz, Three-Phase, 5% Impedance (continued)**

kW	Hp	Duty ♦	Input Line Reactor ‡		Output Reactor ‡		Used with PowerFlex Drive					
			IPO0 (Open Style)	IP11 (NEMA/UL Type 1)	IPO0 (Open Style)	IP11 (NEMA/UL Type 1)	70	700	700H	700S	700L	753/755
–	400	Light/Normal/Heavy	1321-3R500-C	1321-3RA500-C	1321-3R500-C	1321-3RA500-C						✓
298	400	Normal/Heavy	1321-3R500-C	1321-3RA500-C	1321-3R500-C	1321-3RA500-C		✓				
315	–	Light/Normal/Heavy	1321-3R600-C	1321-3RA600-C	1321-3R600-C	1321-3RA600-C						✓
336	450	Normal/Heavy	1321-3RA600-C	1321-3RA600-C	1321-3R500-C	1321-3RA500-C		✓	✓			
–	450	Light/Normal/Heavy	1321-3R600-C	1321-3RA600-C	1321-3R600-C	1321-3RA600-C						✓
355	–	Light/Normal/Heavy	1321-3R750-C	1321-3RA750-C	1321-3R750-C	1321-3RA750-C						✓
373	500	Normal/Heavy	1321-3R600-C	1321-3RA600-C	1321-3R600-C	1321-3RA600-C		✓	✓			
–	500	Light	1321-3R600-C	1321-3RA600-C	1321-3R600-C	1321-3RA600-C						✓
		Normal/Heavy	1321-3R750-C	1321-3RA750-C	1321-3R750-C	1321-3RA750-C						✓
400	–	Light/Heavy	1321-3R750-C	1321-3RA750-C	1321-3R750-C	1321-3RA750-C						✓
		Normal	1321-3R850-C	1321-3RA850-C	1321-3R850-C	1321-3RA850-C						✓
448	600	Normal/Heavy	1321-3R750-E	1321-3RA750-E	1321-3R750-E	1321-3RA750-E		✓				
–	600	Light/Normal/Heavy	1321-3R750-C	1321-3RA750-C	1321-3R750-C	1321-3RA750-C						✓
450	–	Light	1321-3R850-C	1321-3RA850-C	1321-3R850-C	1321-3RA850-C						✓
500	–	Normal/Heavy	1321-3R1000-C	1321-3RA1000-C	1321-3R1000-C	1321-3RA1000-C						✓
522	600	Normal/Heavy	1321-3R750-C	1321-3RA750-C	1321-3R750-C	1321-3RA750-C			✓ ★			
–	650	Light	1321-3R850-C	1321-3RA850-C	1321-3R850-C	1321-3RA850-C						✓
		Normal	1321-3R750-C	1321-3RA750-C	1321-3R750-C	1321-3RA750-C						✓
–	700	Light/Normal/Heavy	1321-3R850-C	1321-3RA850-C	1321-3R850-C	1321-3RA850-C						✓
522	700	Normal	1321-3R850-C	1321-3RA850-C	1321-3R850-C	1321-3RA850-C		✓				
		Normal	–	–	1321-3RB400-C	1321-3RAB400-C			✓ §			
671	700	Heavy	–	–	1321-3RB400-C	1321-3RAB400-C			✓ §			
–	750	Heavy	1321-3R850-C	1321-3RA850-C	1321-3R850-C	1321-3RA850-C						✓
–	800	Light/Normal/Heavy	1321-3R1000-C	1321-3RA1000-C	1321-3R1000-C	1321-3RA1000-C						✓
560	–	Light/Normal/Heavy	1321-3R600-C	1321-3RA600-C	1321-3R600-C	1321-3RA600-C						✓ §
597	800	Normal	–	–	1321-3R500-C	1321-3RA500-C			✓ §			
630	–	Light/Normal/Heavy	1321-3R600-C	1321-3RA600-C	1321-3R600-C	1321-3RA600-C						✓ §
746	800	Heavy	–	–	1321-3R500-C	1321-3RA500-C			✓ §			
–	900	Light/Normal/Heavy	1321-3R600-C	1321-3RA600-C	1321-3R600-C	1321-3RA600-C						✓ §
671	900	Normal	–	–	1321-3R500-C	1321-3RA500-C			✓ §			
		Heavy	–	–	1321-3RA600-C	1321-3RA600-C			✓ §			
710	–	Light/Normal/Heavy	1321-3R600-C	1321-3RA600-C	1321-3R600-C	1321-3RA600-C						✓ §
–	1000	Light/Normal/Heavy	1321-3R600-C	1321-3RA600-C	1321-3R600-C	1321-3RA600-C						✓ §
746	1000	Normal	–	–	1321-3RA600-C	1321-3RA600-C			✓ §			
		Heavy	–	–	1321-3R750-C	1321-3RA750-C			✓ § ★			
–	1100	Light/Normal	1321-3R750-C	1321-3RA750-C	1321-3R750-C	1321-3RA750-C						✓ §
800	–	Light/Normal	1321-3R750-C	1321-3RA750-C	1321-3R750-C	1321-3RA750-C						✓ §
850	–	Light/Normal	1321-3R750-C	1321-3RA750-C	1321-3R750-C	1321-3RA750-C						✓ §
895	1200	Normal	–	–	1321-3R750-C	1321-3RA750-C			✓ § ★			
–	1250	Light/Normal	1321-3R750-C	1321-3RA750-C	1321-3R750-C	1321-3RA750-C						✓ §
900	–	Light	1321-3R850-C	1321-3RA850-C	1321-3R850-C	1321-3RA850-C						✓ §
933	1250	Normal	–	–	1321-3R750-C	1321-3RA750-C			✓ §			
–	1350	Light	1321-3R850-C	1321-3RA850-C	1321-3R850-C	1321-3RA850-C						✓ §
–	1500	Light	1321-3R850-C	1321-3RA850-C	1321-3R850-C	1321-3RA850-C						✓ ♣
1000	–	Light	1321-3R850-C	1321-3RA850-C	1321-3R850-C	1321-3RA850-C						✓ ♣
–	2000	Light	1321-3R850-C	1321-3RA850-C	1321-3R850-C	1321-3RA850-C						✓ ♣
1400	–	Light	1321-3R850-C	1321-3RA850-C	1321-3R850-C	1321-3RA850-C						✓ ♣

‡ Input line reactors were sized based on the NEC fundamental motor amps (PowerFlex 700H has an integral input reactor). Output line reactors were sized based on the VFD rated output currents.

★ 4% impedance.

♣ Requires three reactors wired in parallel.

§ Requires two output reactors wired in parallel.

♦ Light Duty refers to PowerFlex 755 drives only.



## Input and Output Reactors - 500...690V, 50/60 Hz, Three-Phase, 3% Impedance

kW	Hp	Duty	Input Line Reactor ‡		Output Reactor ‡		Used with PowerFlex Drive					
			IPO0 (Open Style)	IP11 (NEMA/UL Type 1)	IPO0 (Open Style)	IP11 (NEMA/UL Type 1)	70	700	700H	700S	700L	753/755
0.25	0.33	Heavy	1321-3R1-C	1321-3RA1-C	1321-3R1-B	1321-3RA1-B	✓					
0.37	0.5	Normal	1321-3R1-C	1321-3RA1-C	1321-3R1-B	1321-3RA1-B	✓					
		Heavy	1321-3R1-C	1321-3RA1-C	1321-3R2-B	1321-3RA2-B		✓		✓		
0.55	0.75	Heavy	1321-3R2-B	1321-3RA2-B	1321-3R2-B	1321-3RA2-B	✓					
0.75	1	Normal	1321-3R2-B	1321-3RA2-B	1321-3R2-B	1321-3RA2-B	✓	✓		✓		✓
		Heavy	1321-3R2-B	1321-3RA2-B	1321-3R4-D	1321-3RA4-D		✓		✓		✓
1.1	1.5	Heavy	1321-3R2-A	1321-3RA2-A	1321-3R4-D	1321-3RA4-D	✓					
1.5	2	Normal	1321-3R4-C	1321-3RA4-C	1321-3R4-D	1321-3RA4-D	✓					
		Heavy	1321-3R4-C	1321-3RA4-C	1321-3R4-C	1321-3RA4-C	✓					✓
		Normal	1321-3R4-D	1321-3RA4-D	1321-3R4-D	1321-3RA4-D		✓		✓		✓
		Heavy	1321-3R4-D	1321-3RA4-D	1321-3R4-C	1321-3RA4-C		✓		✓		✓
2.2	3	Normal	1321-3R4-C	1321-3RA4-C	1321-3R4-C	1321-3RA4-C	✓	✓		✓		✓
		Heavy	1321-3R4-C	1321-3RA4-C	1321-3R8-C	1321-3RA8-C	✓	✓		✓		
4	5	Normal	1321-3R8-C	1321-3RA8-C	1321-3R8-C	1321-3RA8-C	✓	✓		✓		✓
		Heavy	1321-3R8-C	1321-3RA8-C	1321-3R12-C	1321-3RA12-C	✓	✓		✓		✓
5.5	7.5	Normal	1321-3R12-C	1321-3RA12-C	1321-3R12-C	1321-3RA12-C	✓	✓		✓		✓
		Heavy	1321-3R12-C	1321-3RA12-C	1321-3R12-B	1321-3RA12-B	✓	✓		✓		✓
7.5	10	Normal	1321-3R12-B	1321-3RA12-B	1321-3R12-B	1321-3RA12-B	✓	✓		✓		✓
		Heavy	1321-3R12-B	1321-3RA12-B	1321-3R18-B	1321-3RA18-B	✓	✓		✓		✓
11	15	Normal	1321-3R18-B	1321-3RA18-B	1321-3R18-B	1321-3RA18-B	✓	✓		✓		✓
		Heavy	1321-3R18-B	1321-3RA18-B	1321-3R25-B	1321-3RA25-B	✓	✓		✓		✓
15	20	Normal	1321-3R25-B	1321-3RA25-B	1321-3R25-B	1321-3RA25-B	✓	✓		✓		✓
		Heavy	1321-3R25-B	1321-3RA25-B	1321-3R35-C	1321-3RA35-C	✓	✓		✓		✓
18.5	25	Normal	1321-3R35-C	1321-3RA35-C	1321-3R35-C	1321-3RA35-C	✓	✓		✓		✓
		Heavy	1321-3R35-C	1321-3RA35-C	1321-3R35-B	1321-3RA35-B	✓	✓		✓		✓
22	30	Normal	1321-3R35-B	1321-3RA35-B	1321-3R35-B	1321-3RA35-B	✓	✓		✓		✓
		Heavy	1321-3R35-B	1321-3RA35-B	1321-3R45-B	1321-3RA45-B	✓	✓		✓		✓
30	40	Normal	1321-3R45-B	1321-3RA45-B	1321-3R45-B	1321-3RA45-B	✓	✓		✓		✓
		Heavy	1321-3R45-B	1321-3RA45-B	1321-3R55-B	1321-3RA55-B	✓	✓		✓		✓
37	50	Normal	1321-3R55-B	1321-3RA55-B	1321-3R55-B	1321-3RA55-B	✓	✓		✓		✓
		Heavy	1321-3R55-B	1321-3RA55-B	1321-3R80-B	1321-3RA80-B		✓		✓		✓
45	60	Normal/Heavy	1321-3R80-B	1321-3RA80-B	1321-3R80-B	1321-3RA80-B		✓		✓		✓
55	75	Normal/Heavy	1321-3R80-B	1321-3RA80-B	1321-3R80-B	1321-3RA80-B		✓		✓		✓
75	100	Normal/Heavy	1321-3R100-B	1321-3RA100-B	1321-3R100-B	1321-3RA100-B		✓		✓		✓
90	125	Normal/Heavy	1321-3R130-B	1321-3RA130-B	1321-3R130-B	1321-3RA130-B		✓		✓		✓
110	150	Normal	1321-3R160-B	1321-3RA160-B	1321-3R160-B	1321-3RA160-B		✓		✓		✓
		Normal/Heavy	—	—	1321-3R200-C	1321-3RA200-C			✓			
132	—	Heavy	—	—	1321-3RB250-C	1321-3RAB250-C			✓			
149	200	Normal/Heavy	—	—	1321-3R200-B	1321-3RA200-B			✓			
160	—	Normal/Heavy	—	—	1321-3RB250-C	1321-3RAB250-C			✓			
187	250	Normal/Heavy	—	—	1321-3RB250-B	1321-3RAB250-B			✓			
—	300	Heavy	1321-3RB320-B	1321-3RAB320-B	1321-3RB320-B	1321-3RAB320-B						✓
200	—	Normal	—	—	1321-3RB250-C	1321-3RAB250-C			✓			
		Heavy	—	—	1321-3RB320-C	1321-3RAB320-C			✓			
		Heavy	1321-3R250-B	1321-3RA250-B	1321-3R250-B	1321-3RA250-B						✓
—	350	Light/Normal/Heavy	1321-3RB400-B	1321-3RAB400-B	1321-3RB400-B	1321-3RAB400-B						✓
250	—	Normal	—	—	1321-3RB320-C	1321-3RAB320-C			✓			
		Heavy	—	—	1321-3RB400-C	1321-3RAB400-C			✓			
		Normal/Heavy	1321-3RB320-B	1321-3RAB320-B	1321-3RB320-B	1321-3RAB320-B						✓

continued

## Input and Output Reactors - 500...690V, 50/60 Hz, Three-Phase, 3% Impedance (continued)

kW	Hp	Duty	Input Line Reactor ‡		Output Reactor ‡		Used with PowerFlex Drive					
			IPO0 (Open Style)	IP11 (NEMA/UL Type 1)	IPO0 (Open Style)	IP11 (NEMA/UL Type 1)	70	700	700H	700S	700L	753/755
261	350	Normal/Heavy	–	–	1321-3RB320-B	1321-3RAB320-B			✓			
298	400	Normal/Heavy	–	–	1321-3RB400-B	1321-3RAB400-B			✓			
–	400	Light/Normal/Heavy	1321-3RB400-B	1321-3RAB400-B	1321-3RB400-B	1321-3RAB400-B						✓
300	–	Heavy	1321-3RB400-B	1321-3RAB400-B	1321-3RB400-B	1321-3RAB400-B						✓
–	450	Light/Normal/Heavy	1321-3R500-B	1321-3RA500-B	1321-3R500-B	1321-3RA500-B						✓
315	–	Normal	–	–	1321-3RB400-C	1321-3RAB400-C			✓			
		Heavy	–	–	1321-3R500-C	1321-3RA500-C			✓			
		Light/Normal	1321-3RB400-B	1321-3RAB400-B	1321-3RB400-B	1321-3RAB400-B						✓
336	450	Normal	–	–	1321-3RB400-B	1321-3RAB400-B			✓			
		Normal	–	–	1321-3R500-B	1321-3RA500-B			✓			
		Heavy	–	–	1321-3RB400-B	1321-3RAB400-B			✓			
–	500	Light/Normal/Heavy	1321-3R600-B	1321-3RA600-B	1321-3R600-B	1321-3RA600-B						✓
355	–	Normal	–	–	1321-3R500-C	1321-3RA500-C			✓			
		Heavy	–	–	1321-3R600-C	1321-3RA600-C			✓			
		Light/Normal/Heavy	1321-3R500-B	1321-3RA500-B	1321-3R500-B	1321-3RA500-B						✓
373	500	Normal/Heavy	–	–	1321-3R500-B	1321-3RA500-B			✓			
–	550	Light	1321-3R600-B	1321-3RA600-B	1321-3R600-B	1321-3RA600-B						✓
375	–	Heavy	1321-3R500-B	1321-3RA500-B	1321-3R500-B	1321-3RA500-B						✓
400	–	Normal	–	–	1321-3R500-C	1321-3RA500-C			✓			
		Light/Normal/Heavy	1321-3R500-B	1321-3RA500-B	1321-3R500-B	1321-3RA500-B						✓
448	600	Normal	–	–	1321-3R600-B	1321-3RA600-B			✓			
–	600	Normal/Heavy	1321-3R600-B	1321-3RA600-B	1321-3R600-B	1321-3RA600-B						✓
450	–	Normal/Heavy	–	–	1321-3R600-C	1321-3RA600-C			✓			
		Light/Normal	1321-3R600-B	1321-3RA600-B	1321-3R600-B	1321-3RA600-B						✓
485	650	Heavy	–	–	1321-3RB320-B	1321-3RAB320-B			✓ §			
500	–	Normal	–	–	1321-3R600-C	1321-3RA600-C			✓			
		Heavy	–	–	1321-3R750-C	1321-3RA750-C			✓			
		Light/Normal/Heavy	1321-3R600-B	1321-3RA600-B	1321-3R600-B	1321-3RA600-B						✓
522	700	Normal	–	–	1321-3RB320-B	1321-3RAB320-B			✓ §			
		Heavy	–	–	1321-3RB400-C	1321-3RAB400-C			✓ §			
–	700	Light/Normal/Heavy	1321-3R750-B	1321-3RA750-B	1321-3R750-B	1321-3RA750-B						✓
530	–	Light	1321-3R600-B	1321-3RA600-B	1321-3R600-B	1321-3RA600-B						✓
560	–	Normal	–	–	1321-3R750-C	1321-3RA750-C			✓			
		Heavy	–	–	1321-3RB400-C	1321-3RAB400-C			✓ §			
		Normal/Heavy	1321-3R750-B	1321-3RA750-B	1321-3R750-B	1321-3RA750-B						✓
–	750	Heavy	1321-3R750-B	1321-3RA750-B	1321-3R750-B	1321-3RA750-B						✓
597	800	Normal	–	–	1321-3RB400-C	1321-3RAB400-C			✓ §			
–	800	Light/Normal/Heavy	1321-3R850-B	1321-3RA850-B	1321-3R850-B	1321-3RA850-B						✓
630	–	Normal	–	–	1321-3RB400-C	1321-3RAB400-C			✓ §			
		Heavy	–	–	1321-3R500-C	1321-3RA500-C			✓ §			
		Light/Normal/Heavy	1321-3R750-B	1321-3RA750-B	1321-3R750-B	1321-3RA750-B						✓
671	900	Normal	–	–	1321-3RB400-B	1321-3RAB400-B			✓ §			
		Heavy	–	–	1321-3R1000-C	1321-3RA1000-C			✓			
–	900	Light/Normal/Heavy	1321-3R850-B	1321-3RA850-B	1321-3R850-B	1321-3RA850-B						✓
710	–	Normal	–	–	1321-3R500-C	1321-3RA500-C			✓ §			
		Light/Normal/Heavy	1321-3R850-B	1321-3RA850-B	1321-3R850-B	1321-3RA850-B						✓
–	950	Light/Normal	1321-3R1000-B	1321-3RA1000-B	1321-3R1000-B	1321-3RA1000-B						✓

continued

## Input and Output Reactors - 500...690V, 50/60 Hz, Three-Phase, 3% Impedance (continued)

kW	Hp	Duty	Input Line Reactor ‡		Output Reactor ‡		Used with PowerFlex Drive					
			IPO0 (Open Style)	IP11 (NEMA/UL Type 1)	IPO0 (Open Style)	IP11 (NEMA/UL Type 1)	70	700	700H	700S	700L	753/755
746	1000	Normal	–	–	1321-3R1000-C	1321-3RA1000-C			✓			
		Heavy	–	–	1321-3R1000-B	1321-3RA1000-B			✓			
750	–	Normal	1321-3R850-B	1321-3RA850-B	1321-3R850-B	1321-3RA850-B						✓
800	–	Normal	–	–	1321-3R500-C	1321-3RA500-C			✓ §			
		Heavy	–	–	1321-3R600-C	1321-3RA600-C			✓ §			
		Light/Normal/Heavy	1321-3R1000-B	1321-3RA1000-B	1321-3R1000-B	1321-3RA1000-B						✓
–	1000	Light/Normal	1321-3R1000-B	1321-3RA1000-B	1321-3R1000-B	1321-3RA1000-B						✓
821	1100	Normal	–	–	1321-3R1000-B	1321-3RA1000-B			✓			
		Heavy	–	–	1321-3R600-B	1321-3RA600-B			✓ §			
–	1100	Light	1321-3R600-B	1321-3RA600-B	1321-3R600-B	1321-3RA600-B						✓ §
850	–	Light	1321-3R1000-B	1321-3RA1000-B	1321-3R1000-B	1321-3RA1000-B						✓
900	–	Normal/Heavy	–	–	1321-3R600-C	1321-3RA600-C			✓ §			
		Light/Normal	1321-3R600-B	1321-3RA600-B	1321-3R600-B	1321-3RA600-B						✓ §
970	1300	Normal	–	–	1321-3R600-B	1321-3RA600-B			✓ §			
1000	–	Normal	–	–	1321-3R600-C	1321-3RA600-C			✓ §			
		Heavy	–	–	1321-3R750-C	1321-3RA750-C			✓ §			
		Light	1321-3R600-B	1321-3RA600-B	1321-3R600-B	1321-3RA600-B						✓ §
1100	–	Normal	–	–	1321-3R750-C	1321-3RA750-C			✓ §			
		Light/Normal	1321-3R600-B	1321-3RA600-B	1321-3R600-B	1321-3RA600-B						✓ ♠
–	1200	Light	1321-3R600-B	1321-3RA600-B	1321-3R600-B	1321-3RA600-B						✓ ♠
1500	–	Light/Normal	1321-3R600-B	1321-3RA600-B	1321-3R600-B	1321-3RA600-B						✓ ♠
–	1500	Light	1321-3R600-B	1321-3RA600-B	1321-3R600-B	1321-3RA600-B						✓ ♠

‡ Input line reactors were sized based on the NEC fundamental motor amps (PowerFlex 700H has an integral input reactor). Output line reactors were sized based on the VFD rated output currents.

§ Requires two reactors wired in parallel.

♠ Requires three reactors wired in parallel.

**Input and Output Reactors - 500...690V, 50/60 Hz, Three-Phase, 5% Impedance**

kW	Hp	Duty	Input Line Reactor ‡		Output Reactor ‡		Used with PowerFlex Drive					
			IPO0 (Open Style)	IP11 (NEMA/UL Type 1)	IPO0 (Open Style)	IP11 (NEMA/UL Type 1)	70	700	700H	700S	700L	753/755
0.25	0.33	Heavy	1321-3R1-A	1321-3RA1-A	1321-3R1-B	1321-3RA1-B	✓					
0.37	0.5	Normal	1321-3R1-B	1321-3RA1-B	1321-3R1-B	1321-3RA1-B	✓					
0.37	0.5	Heavy	1321-3R1-B	1321-3RA1-B	1321-3R2-C	1321-3RA2-C		✓		✓		
0.55	0.75	Heavy	1321-3R2-C	1321-3RA2-C	1321-3R2-C	1321-3RA2-C	✓					
0.75	1	Normal	1321-3R2-C	1321-3RA2-C	1321-3R2-C	1321-3RA2-C	✓	✓		✓		✓
		Heavy	1321-3R2-C	1321-3RA2-C	1321-3R4-D	1321-3RA4-D		✓		✓		✓
1.1	1.5	Heavy	1321-3R2-B	1321-3RA2-B	1321-3R4-D	1321-3RA4-D	✓	✓		✓		
1.5	2	Normal/Heavy	1321-3R4-D	1321-3RA4-D	1321-3R4-D	1321-3RA4-D	✓	✓		✓		✓
2.2	3	Normal	1321-3R4-D	1321-3RA4-D	1321-3R4-D	1321-3RA4-D	✓	✓		✓		✓
		Heavy	1321-3R4-D	1321-3RA4-D	1321-3R8-D	1321-3RA8-D	✓	✓		✓		✓
4	5	Normal	1321-3R8-D	1321-3RA8-D	1321-3R8-D	1321-3RA8-D	✓	✓		✓		✓
		Heavy	1321-3R8-D	1321-3RA8-D	1321-3R12-C	1321-3RA12-C	✓	✓		✓		✓
5.5	7.5	Normal/Heavy	1321-3R12-C	1321-3RA12-C	1321-3R12-C	1321-3RA12-C	✓	✓		✓		✓
7.5	10	Normal	1321-3R12-C	1321-3RA12-C	1321-3R12-C	1321-3RA12-C	✓	✓		✓		✓
		Heavy	1321-3R12-C	1321-3RA12-C	1321-3R18-C	1321-3RA18-C	✓	✓		✓		✓
11	15	Normal	1321-3R18-C	1321-3RA18-C	1321-3R18-C	1321-3RA18-C	✓	✓		✓		✓
		Heavy	1321-3R18-C	1321-3RA18-C	1321-3R25-C	1321-3RA25-C	✓	✓		✓		✓
15	20	Normal	1321-3R25-C	1321-3RA25-C	1321-3R25-C	1321-3RA25-C	✓	✓		✓		✓
		Heavy	1321-3R25-C	1321-3RA25-C	1321-3R35-C	1321-3RA35-C	✓	✓		✓		✓
18.5	25	Normal/Heavy	1321-3R35-C	1321-3RA35-C	1321-3R35-C	1321-3RA35-C	✓	✓		✓		✓
22	30	Normal	1321-3R35-C	1321-3RA35-C	1321-3R35-C	1321-3RA35-C	✓	✓		✓		✓
		Heavy	1321-3R35-C	1321-3RA35-C	1321-3R45-C	1321-3RA45-C	✓	✓		✓		✓
30	40	Normal	1321-3R45-C	1321-3RA45-C	1321-3R45-C	1321-3RA45-C	✓	✓		✓		✓
		Heavy	1321-3R45-C	1321-3RA45-C	1321-3R55-C	1321-3RA55-C	✓	✓		✓		✓
37	50	Normal	1321-3R55-C	1321-3RA55-C	1321-3R55-C	1321-3RA55-C	✓	✓		✓		✓
		Heavy	1321-3R55-C	1321-3RA55-C	1321-3R80-C	1321-3RA80-C		✓		✓		✓
45	60	Normal/Heavy	1321-3R80-C	1321-3RA80-C	1321-3R80-C	1321-3RA80-C		✓		✓		✓
55	75	Normal/Heavy	1321-3R80-C	1321-3RA80-C	1321-3R80-C	1321-3RA80-C		✓		✓		✓
75	100	Normal/Heavy	1321-3R100-C	1321-3RA100-C	1321-3R100-C	1321-3RA100-C		✓		✓		✓
90	125	Normal/Heavy	1321-3R130-C	1321-3RA130-C	1321-3R130-C	1321-3RA130-C		✓		✓		✓
110	150	Normal	1321-3R160-C	1321-3RA160-C	1321-3R160-C	1321-3RA160-C		✓		✓		✓
		Heavy	—	—	1321-3R160-C	1321-3RA160-C			✓ ★			
		Normal	—	—	1321-3R200-C	1321-3RA200-C			✓ △			
149	200	Normal	—	—	1321-3R200-B	1321-3RA200-B			✓ ★			
		Heavy	—	—	1321-3R200-C	1321-3RA200-C			✓ ★			
187	250	Normal/Heavy	—	—	1321-3RB250-C	1321-3RAB250-C			✓ ★			
—	300	Heavy	1321-3RB320-C	1321-3RAB320-C	1321-3RB320-C	1321-3RAB320-C						✓
200	—	Heavy	1321-3R250-C	1321-3RA250-C	1321-3R250-C	1321-3RA250-C						✓
—	350	Light/Normal/Heavy	1321-3RB400-C	1321-3RAB400-C	1321-3RB400-C	1321-3RAB400-C						✓
250	—	Normal/Heavy	1321-3RB320-C	1321-3RAB320-C	1321-3RB320-C	1321-3RAB320-C						✓
261	350	Normal/Heavy	—	—	1321-3RB320-C	1321-3RAB320-C			✓ ★			
—	400	Light/Normal/Heavy	1321-3RB400-C	1321-3RAB400-C	1321-3RB400-C	1321-3RAB400-C						✓
298	400	Normal/Heavy	—	—	1321-3RB400-C	1321-3RAB400-C			✓ ★			

continued

‡ Input line reactors were sized based on the NEC fundamental motor amps (PowerFlex 700H has an integral input reactor). Output line reactors were sized based on the VFD rated output currents.

★ 4% impedance.

△ 3% impedance.

## Input and Output Reactors - 500...690V, 50/60 Hz, Three-Phase, 5% Impedance (continued)

kW	Hp	Duty	Input Line Reactor ‡		Output Reactor ‡		Used with PowerFlex Drive					
			IP00 (Open Style)	IP11 (NEMA/UL Type 1)	IP00 (Open Style)	IP11 (NEMA/UL Type 1)	70	700	700H	700S	700L	753/755
300	–	Heavy	1321-3RB400-C	1321-3RAB400-C	1321-3RB400-C	1321-3RAB400-C						✓
315	–	Light/Normal	1321-3RB400-C	1321-3RAB400-C	1321-3RB400-C	1321-3RAB400-C						✓
–	450	Light/Normal/Heavy	1321-3R500-C	1321-3RA500-C	1321-3R500-C	1321-3RA500-C						✓
336	450	Normal	–	–	1321-3R500-C	1321-3RA500-C			✓ ★			
		Heavy	–	–	1321-3RB400-C	1321-3RAB400-C			✓			
–	500	Light/Normal	1321-3R600-C	1321-3RA600-C	1321-3R600-C	1321-3RA600-C						✓
355	–	Light/Normal/Heavy	1321-3R500-C	1321-3RA500-C	1321-3R500-C	1321-3RA500-C						✓
373	500	Normal/Heavy	–	–	1321-3R500-C	1321-3RA500-C			✓			
–	550	Light	1321-3R600-C	1321-3RA600-C	1321-3R600-C	1321-3RA600-C						✓
375	–	Heavy	1321-3R500-C	1321-3RA500-C	1321-3R500-C	1321-3RA500-C						✓
400	–	Light/Normal/Heavy	1321-3R500-C	1321-3RA500-C	1321-3R500-C	1321-3RA500-C						✓
448	600	Normal	–	–	1321-3R600-C	1321-3RA600-C			✓ ★			
–	600	Normal/Heavy	1321-3R600-C	1321-3RA600-C	1321-3R600-C	1321-3RA600-C						✓
450	–	Light/Normal/Heavy	1321-3R600-C	1321-3RA600-C	1321-3R600-C	1321-3RA600-C						✓
485	650	Heavy	–	–	1321-3RB320-C	1321-3RAB320-C			✓ ★ §			
500	–	Heavy	1321-3R600-C	1321-3RA600-C	1321-3R600-C	1321-3RA600-C						✓
522	700	Normal	–	–	1321-3RB320-C	1321-3RAB320-C			✓ ★ §			
		Heavy	–	–	1321-3RB400-C	1321-3RAB400-C			✓ ★ §			
–	700	Light/Normal/Heavy	1321-3R750-C	1321-3RA750-C	1321-3R750-C	1321-3RA750-C						✓
530	–	Light	1321-3R600-C	1321-3RA600-C	1321-3R600-C	1321-3RA600-C						✓
–	750	Heavy	1321-3R750-C	1321-3RA750-C	1321-3R750-C	1321-3RA750-C						✓
560	–	Normal/Heavy	1321-3R750-C	1321-3RA750-C	1321-3R750-C	1321-3RA750-C						✓
597	800	Normal	–	–	1321-3RB400-C	1321-3RAB400-C			✓ ★ §			
–	800	Light/Normal/Heavy	1321-3R850-C	1321-3RA850-C	1321-3R850-C	1321-3RA850-C						✓
630	–	Light/Normal/Heavy	1321-3R750-C	1321-3RA750-C	1321-3R750-C	1321-3RA750-C						✓
671	900	Normal	–	–	1321-3RB400-C	1321-3RAB400-C			✓ §			
		Heavy	–	–	1321-3R500-C	1321-3RA500-C			✓ ★ §			
–	900	Light/Normal/Heavy	1321-3R850-C	1321-3RA850-C	1321-3R850-C	1321-3RA850-C						✓
–	950	Light/Normal	1321-3R1000-C	1321-3RA1000-C	1321-3R1000-C	1321-3RA1000-C						✓
710	–	Light/Normal/Heavy	1321-3R850-C	1321-3RA850-C	1321-3R850-C	1321-3RA850-C						✓
746	1000	Normal	–	–	1321-3R500-C	1321-3RA500-C			✓ ★ §			
		Heavy	–	–	1321-3R1000-C	1321-3RA1000-C			✓ ★			
750	–	Normal	1321-3R850-C	1321-3RA850-C	1321-3R850-C	1321-3RA850-C						✓
–	1000	Light/Normal	1321-3R1000-C	1321-3RA1000-C	1321-3R1000-C	1321-3RA1000-C						✓
800	–	Light/Normal/Heavy	1321-3R1000-C	1321-3RA1000-C	1321-3R1000-C	1321-3RA1000-C						✓
821	1100	Normal	–	–	1321-3R1000-C	1321-3RA1000-C			✓ ★			
		Heavy	–	–	1321-3R600-C	1321-3RA600-C			✓ ★ §			
–	1100	Light	1321-3R600-C	1321-3RA600-C	1321-3R600-C	1321-3RA600-C						✓ §
850	–	Light	1321-3R1000-C	1321-3RA1000-C	1321-3R1000-C	1321-3RA1000-C						✓
900	–	Light/Normal	1321-3R600-C	1321-3RA600-C	1321-3R600-C	1321-3RA600-C						✓ §
970	1300	Normal	–	–	1321-3R600-C	1321-3RA600-C			✓ ★ §			
1000	–	Light	1321-3R600-C	1321-3RA600-C	1321-3R600-C	1321-3RA600-C						✓ §
1100	–	Light/Normal	1321-3R600-C	1321-3RA600-C	1321-3R600-C	1321-3RA600-C						✓ ♣
–	1200	Light	1321-3R600-C	1321-3RA600-C	1321-3R600-C	1321-3RA600-C						✓ ♣
1500	–	Light/Normal	1321-3R600-C	1321-3RA600-C	1321-3R600-C	1321-3RA600-C						✓ ♣
–	1500	Light	1321-3R600-C	1321-3RA600-C	1321-3R600-C	1321-3RA600-C						✓ ♣

‡ Input line reactors were sized based on the NEC fundamental motor amps (PowerFlex 700H has an integral input reactor). Output line reactors were sized based on the VFD rated output currents.

★ 4% impedance.

§ Requires two output reactors wired in parallel.

♣ Requires three reactors wired in parallel.

# Rockwell Automation Services and Support



Rockwell Automation Services & Support can help you meet your everyday technical needs and maximize your return on automation investments by providing value-add maintenance, lifecycle management and system optimization solutions. Applicable

throughout your entire enterprise, these solutions can help you meet your goals by increasing speed to change, improving equipment performance to specifications, decreasing downtime and reducing costs. They will also help you create a more sustainable production environment by reducing energy consumption, driving green initiatives and improving safety.

**Assurance™ Integrated Support** is a service agreement covering all of your remote support, replacement parts and on-site service needs for one fixed fee.

**Remote Support & Monitoring** provides your site with unlimited access to our technical support engineers through TechConnect<sup>SM</sup> Support. Receive 24x7 support for your products, systems and applications on the phone or via the Rockwell Automation Support Center Knowledgebase, forums, live chat and “Submit Questions” email support. TechConnect also provides the most current and released software downloads.

**Network and Security Services** provide you with a knowledgeable team, expertly trained in both manufacturing and IT with domain expertise to provide you with the appropriate services your industrial control and information networks require.

**Safety Services** help you comply with safety standards to reduce the risk of injuries and improve productivity. Our global safety team of principle consultants can help you at any step of a safeguarding project – from training and standards assistance through validation and startup.

**Training Services** provides a Drives Curriculum Map with over a dozen drive-specific instructor-led training courses. In addition, web-based training materials are also available.

**Repair Services** from Rockwell Automation, the original equipment manufacturer, can provide complete, cost-effective remanufacturing services and factory enhancements that extend equipment life, enhancing its performance and compatibility.

## **Remanufacturing Services**

Three delivery/warranty options:

- Next Day (24 month warranty)\*
- 3-5 Days (18 month warranty)\*
- 2-3 Weeks (12 month warranty)\*

\* Delivery options for US only

## **Repair of non-Rockwell Automation Products**

- Single source for all electric/electronic, mechanical, and servo repairs
- 200,000+ items, 7000+ manufacturers

## **Annual Repair Agreements**

Take advantage of a fixed price agreement to help you stabilize your annual repair budget, which can include functional validation of spares.

**OnSite Services** provide field service professionals on an as needed, scheduled or full-time basis to perform drive startup services, conversion services or preventive maintenance.

**Startup and Commissioning Services** will quickly commission select drives to help you reduce the time between integration and actual startup. Our standardized process validates that necessary electrical, mechanical and environmental criteria have been met and the appropriate steps have been taken to ensure proper drive operation. This service also comes with an Extended Parts & Labor Warranty.

**Contact an authorized Rockwell Automation distributor or Rockwell Automation representative or visit [www.rockwellautomation.com/services](http://www.rockwellautomation.com/services) for more information.**



# Additional Resources

PowerFlex Drives	<a href="http://www.ab.com/drives">www.ab.com/drives</a>
PowerFlex Drives Catalog Information	<a href="http://www.ab.com/catalogs">www.ab.com/catalogs</a>
Technical Support & Service	<a href="http://www.ab.com/support/abdrives">www.ab.com/support/abdrives</a>
Product Selection Tools	<a href="http://www.ab.com/e-tools">www.ab.com/e-tools</a>
All publications can be found online	<a href="http://www.rockwellautomation.com/literature">www.rockwellautomation.com/literature</a>
Low Voltage PowerFlex Drives Installation Instructions and User Manuals	Search by respective product
PowerFlex DC Selection Guide	20P-SG001_
Drives Wiring & Grounding Guide (PWM) AC Drives	DRIVES-IN001_
Medium Voltage PowerFlex Drives Selection Guide	7000-SG010_
CENTERLINE® 2100 Motor Control Centers Selection Guide	2100-SG003_
CENTERLINE 2500 Motor Control Centers Selection Guide	2500-SG001_
Kinetix Motion Control Selection Guide	GMC-SG001_
Common Bus application reference materials	Search by respective product
Learn More About...	<a href="http://www.rockwellautomation.com/solutions/">www.rockwellautomation.com/solutions/...</a>
Intelligent Motor Control Solutions	<a href="http://www.rockwellautomation.com/solutions/...intelligentcontrol/">...intelligentcontrol/</a>
Integrated Architecture	<a href="http://www.rockwellautomation.com/solutions/...integratedarchitecture/">...integratedarchitecture/</a>
Safety Solutions	<a href="http://www.rockwellautomation.com/solutions/...safety/">...safety/</a>
Sustainability	<a href="http://www.rockwellautomation.com/solutions/...sustainability/">...sustainability/</a>
Essential Components	<a href="http://www.rockwellautomation.com/components">www.rockwellautomation.com/components</a>









# Rockwell Automation Services & Support

**Global Support. Local Address. Peace of Mind.**

Providing the resources you need, when and where you need them, Rockwell Automation has an integrated, global network of ISO-certified repair centers, exchange hubs, field service professionals, IACET-recognized training centers, certified technical phone support centers and online tools.

[www.rockwellautomation.com/services](http://www.rockwellautomation.com/services)



## Meet Your Everyday Technical Needs

Online & Phone Support	Training Services	OnSite Services	Repair Services
<ul style="list-style-type: none"> <li>• System level support</li> <li>• Unlimited, real-time support</li> <li>• Unlimited, online resources and tools</li> <li>• Live chat and support forums</li> </ul>	<ul style="list-style-type: none"> <li>• Instructor-led and computer or web-based courses</li> <li>• Virtual Classroom</li> <li>• Training Assessments</li> <li>• Workstations and job aids</li> </ul>	<ul style="list-style-type: none"> <li>• Embedded engineering</li> <li>• Preventive maintenance</li> <li>• Migrations and conversions</li> <li>• Start-up and commissioning</li> <li>• Troubleshooting and repair</li> <li>• Extended warranty</li> </ul>	<ul style="list-style-type: none"> <li>• Product remanufacturing</li> <li>• Third-party repair</li> <li>• Annual repair agreements</li> </ul>

## Maximize Your Automation Investment

MRO Asset Management	Network & Security Services	Safety Services	Energy Services
<ul style="list-style-type: none"> <li>• Warranty tracking</li> <li>• Consolidated asset reports</li> <li>• Quick access to global spare parts inventory</li> <li>• Owned and managed spare parts inventory</li> </ul>	<ul style="list-style-type: none"> <li>• Control system lifecycle services</li> <li>• Manage network convergence</li> <li>• Security technology, policies and procedures services</li> </ul>	<ul style="list-style-type: none"> <li>• Safety assessments</li> <li>• Safety design, integration and, validation services</li> </ul>	<ul style="list-style-type: none"> <li>• Energy monitoring and analysis services</li> <li>• General and comprehensive energy audits</li> </ul>

Visit the Rockwell Automation Support Center, <http://rockwellautomation.custhelp.com/> for technical information and assistance, plus:

- View technical/application notes
- Obtain software patches
- Subscribe for product/service email notifications
- Submit Questions, Chat Live, Support Forums and more

Visit Get Support Now, [www.rockwellautomation.com/support](http://www.rockwellautomation.com/support) to select your country and find your local support information.

Allen-Bradley, AppView, CENTERLINE, CenterONE, CompactLogix, Connected Components Workbench, ControlLogix, CustomView, DeviceLogix, Direct-to-Drive, DriveExplorer, DriveGuard, DriveLogix, DriveTools, FactoryTalk, FORCE Technology, Integrated Architecture, Kinetix, MCS, PowerCage, PowerFlex, Product Selection Toolbox, ProposalWorks, RailBuilder, RSLogix, Studio 5000, SynchLink and TorqProv are trademarks of Rockwell Automation. CIP Motion, CIP Sync, ControlNet, DeviceNet, EtherNet/IP are trademarks of the Open DeviceNet Vendor Association. Trademarks not belonging to Rockwell Automation are property of their respective companies.

**[www.rockwellautomation.com](http://www.rockwellautomation.com)**

### Power, Control and Information Solutions Headquarters

Americas: Rockwell Automation, 1201 South Second Street, Milwaukee, WI 53204-2496 USA, Tel: (1) 414.382.2000, Fax: (1) 414.382.4444

Europe/Middle East/Africa: Rockwell Automation NV, Pegasus Park, De Kleetlaan 12a, 1831 Diegem, Belgium, Tel: (32) 2 663 0600, Fax: (32) 2 663 0640

Asia Pacific: Rockwell Automation, Level 14, Core F, Cyberport 3, 100 Cyberport Road, Hong Kong, Tel: (852) 2887 4788, Fax: (852) 2508 1846

← spine width = .25 inches